

WELCOME TO / BIENVENUE AU / TE DAMOS LA BIENVENIDA AL

**DAILY**



**BUGLE**



Booklet available in English on  
Livret disponible en français sur  
Folleto disponible en español en

[LEGO.com/service/buildinginstructions](http://LEGO.com/service/buildinginstructions)



EN

# TAKE THE BUGLE TOWER TOUR!

HEY THERE! WELCOME TO THE *DAILY BUGLE TOWER* - THE HOME OF NEW YORK'S MOST TRUSTED NEWS SOURCE. READY FOR A QUICK TOUR? HEAD THIS WAY...

Starting on the ground floor, grab a drink from the cooler and our receptionist will check you in. Out on street level you'll find a host of authentic New York characters and icons. Just try not to make eye contact with Sandman... (continues...)

FR

# LA TOUR EST OUVERTE AUX VISITEURS !

BONJOUR ! BIENVENUE À LA TOUR DU *DAILY BUGLE* - LE DOMICILE DE LA SOURCE DE NOUVELLES LA PLUS FIABLE DE NEW YORK. COMMENÇONS PAR UNE VISITE RAPIDE. PAR ICI...

Au rez-de-chaussée se trouvent un distributeur d'eau fraîche et une réceptionniste prête à inscrire les visiteurs. Une foule de personnages et d'emblèmes authentiques de New York attendent à l'extérieur. Il est recommandé d'éviter d'établir un contact visuel avec Sandman... (à suivre...)

ES

# ¡PARTICIPA EN EL RECORRIDO POR LA TORRE BUGLE!

¡HOLA! TE DAMOS LA BIENVENIDA A LA TORRE DEL *DAILY BUGLE*: EL HOGAR DE LA FUENTE DE NOTICIAS MÁS CONFIABLE DE NUEVA YORK. ¿LISTO PARA UN RECORRIDO RÁPIDO? POR AQUÍ...

Comienza en el piso inferior. Toma una bebida de la hielera mientras nuestra recepcionista te registra. En el exterior encontrarás una amplia variedad de auténticos personajes e íconos de Nueva York. Solo trata de no hacer contacto visual con Sandman... (continúa)

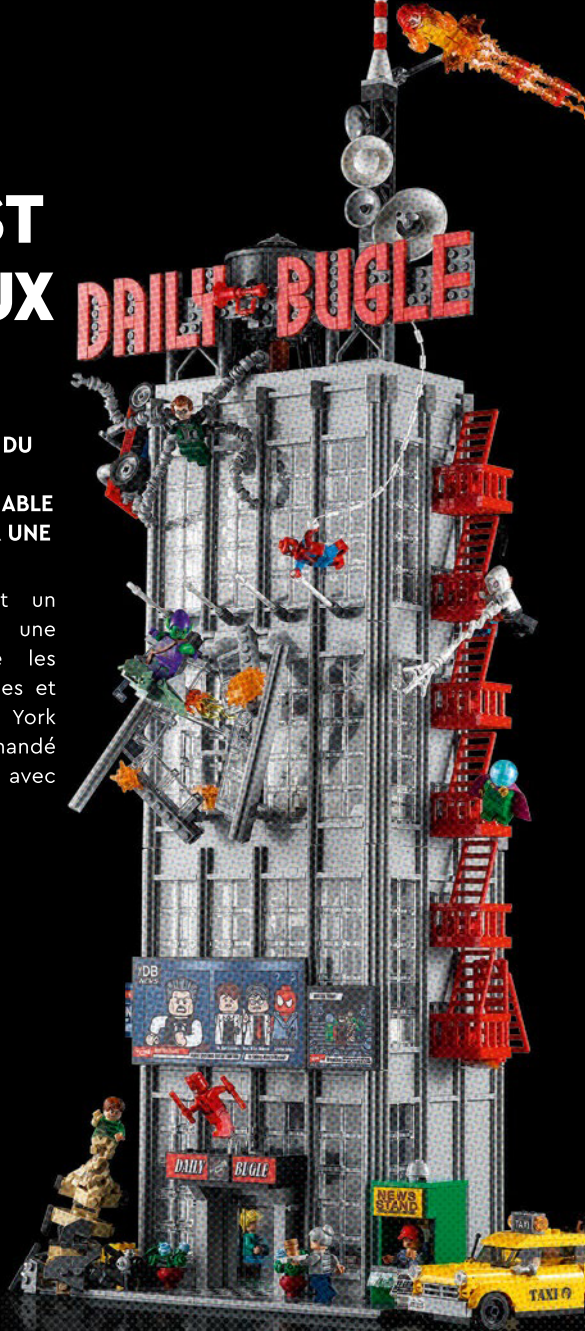

EN Ground floor. FR Rez-de-chaussée. ES Piso inferior.



EN Street level. FR Niveau de la rue. ES Exterior.



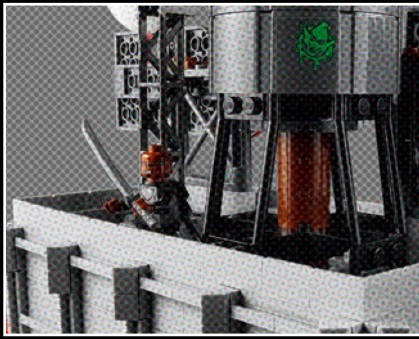

**EN** Blade on roof. **FR** Blade sur le toit.  
**ES** Blade en la azotea.



**EN** Top floor. **FR** Étage supérieur.  
**ES** Piso superior.



**EN** 3rd floor. **FR** 3<sup>e</sup> étage.  
**ES** Tercer piso.



**EN** The bullpen. **FR** Le bureau des journalistes. **ES** La redacción.

**EN**

Let's continue...

Heading up in the elevator, our first stop is the bullpen, the beating heart of the *Daily Bugle's* news operations, where you might catch our team of journalists working on a Spider-Man front page scandal (or just helping themselves to donuts). On the 3rd floor, you'll find our photographer, Peter Parker. He's a ... pretty normal guy. Mind that nasty-looking spider though... On the top floor, you'll find our editor J. Jonah Jameson calling the shots. Best to stay out of his way - he can be a bit grouchy - and DEFINITELY don't mention Spider-Man... You might notice some loud noises during your stay here. Don't worry about that. It's most likely Venom, Doc Ock, Green Goblin or one of the other villains engaged in deadly battle on the exterior of the building. Happens every day. Spider-Man, Daredevil, Blade, or one of the other good guys will be along soon enough to sort them out. And that concludes your tour. Any questions?

**FR**

Continuons...

En direction de l'ascenseur, notre premier arrêt est le bureau à aire ouverte, le cœur des opérations de *Daily Bugle*, où une équipe de journalistes planche sur le prochain grand titre sur Spider-Man (ou mange quelques beignes). Au 3<sup>e</sup> étage se trouve notre photographe, Peter Parker. C'est un gars... assez normal. Attention à l'affreuse araignée... À l'étage supérieur se trouve J. Jonah Jameson, notre directeur. Il vaut mieux rester à l'écart (il peut être assez grognon) et éviter À TOUT PRIX de mentionner Spider-Man... La visite pourrait être ponctuée de quelques bruits assourdissants. C'est tout à fait normal. Ce n'est probablement qu'un affrontement violent entre Venom, le Docteur Octopus et le Bouffon vert ou un autre vilain à l'extérieur du bâtiment. Ça arrive tous les jours. Spider-Man, Daredevil, Blade, ou l'un des autres héros viendra les arrêter bien assez tôt. Et ceci conclut notre visite. Des questions ?

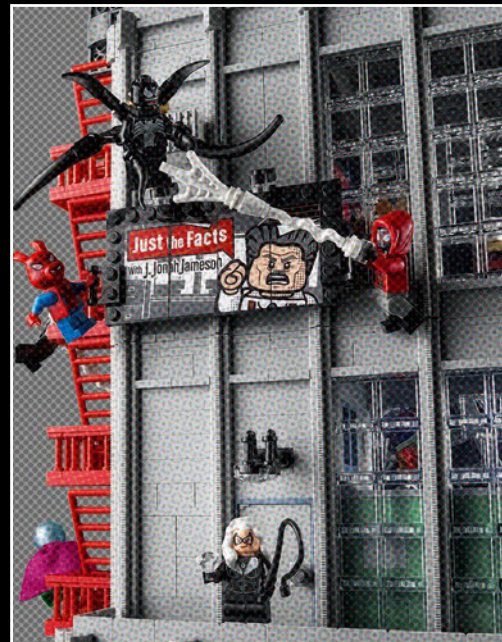

**EN** Venom fight on the backside.  
**FR** Combat contre Venom à l'arrière.  
**ES** Venom pelea en la parte trasera.

**ES**

Sigamos...

Ya en el elevador, nuestra primera parada es la redacción: el corazón de las operaciones informativas del *Daily Bugle*, donde puedes ver a nuestro equipo de periodistas trabajando en una portada protagonizada por Spider-Man (o, simplemente, consintiéndose con las donas). En el tercer piso encontrarás a Peter Parker, nuestro fotógrafo. Es un... tipo bastante normal. Aunque será mejor que tengas cuidado con esa desagradable araña. En el piso superior encontrarás a nuestro redactor jefe, J. Jonah Jameson, dirigiendo todo. Será mejor que te apartes de su camino (es un poco gruñón). Ah, y NO SE TE OCURRA mencionar a Spider-Man... Tal vez oigas ruidos fuertes mientras estás aquí. No tienes de qué preocuparte. Seguramente se trata de Venom, Doc Ock, el Duende Verde u otro villano participando en una peligrosa batalla fuera del edificio. Pasa todos los días. Spider-Man, Daredevil, Blade o algún otro superhéroe llegarán pronto para ocuparse de eso. Y así concluye la visita. ¿Alguna pregunta?



**EN SPIDER-MAN**

The original web-slinging wonder.

**FR SPIDER-MAN**

Le lanceur de toiles original.

**ES SPIDER-MAN**

La maravilla lanzatelañas original.

**EN GHOST-SPIDER**

Gwen Stacey's all-action alter ego.

**FR GHOST-SPIDER**

L'intense alter ego de Gwen Stacy.

**ES GHOST-SPIDER**

La emocionante otra identidad de Gwen Stacy.

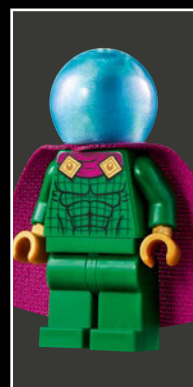
**EN MYSTERIO**

Poisonous villain known for conjuring nasty surprises.

**FR MYSTÉRIO**

Un vilain abrasif reconnu pour ses mauvaises surprises.

**ES MYSTERIO**

Un venenoso villano conocido por dar sorpresas desagradables.

**EN VENOM**

Dark, dangerous villain with alien origins.

**FR VENOM**

Un sinistre et dangereux vilain avec des origines extraterrestres.

**ES VENOM**

Un oscuro y peligroso villano de origen extraterrestre.

**EN MILES MORALES**

Alternate universe Spider-Man with awesome abilities.

**FR MILES MORALES**

Un Spider-Man d'un univers alternatif avec des habiletés impressionnantes.

**ES MILES MORALES**

El Spider-Man de un universo alternativo, con habilidades increíbles.

**EN SANDMAN**

Tricky villain with shape-shifting powers.

**FR SANDMAN**

Un vilain rusé capable de se métamorphoser.

**ES SANDMAN**

Un villano traicionero capaz de cambiar de forma.

**EN CARNAGE**

Powerful alien enemy of Spider-Man and Venom.

**FR CARNAGE**

Un puissant ennemi extraterrestre de Spider-Man et de Venom.

**ES CARNAGE**

El poderoso enemigo extraterrestre de Spider-Man y Venom.

**EN DOCTOR OCTOPUS**

Villain with a deadly combo of brains and tentacles!

**FR DOCTEUR OCTOPUS**

Un vilain brillant avec des tentacules redoutables !

**ES DOCTOR OCTOPUS**

¡Un villano favorecido con una mortífera combinación de cerebro y tentáculos!

**EN GREEN GOBLIN**

Freaky villain with an explosive bag of tricks.

**FR LE BOUFFON VERT**

Un étrange vilain avec plus d'un tour explosif dans son sac.

**ES DUENDE VERDE**

Un villano loco equipado con una bolsa de trucos explosivos.

**EN SPIDER-HAM**

AKA Peter Porker. Part pig, part spider, all hero.

**FR SPIDER-HAM**

Alias Peter Porker. Moitié cochon, moitié araignée; héros à part entière.

**ES SPIDER-HAM**

Alias Peter Porker. Parte cerdo, parte araña, héroe completo.

**EN GWEN STACY**

Peter's college crush & Ghost-Spider alias.

**FR GWEN STACY**

L'amoureuse de Peter au collège et le visage derrière Ghost-Spider.

**ES GWEN STACY**

El amor de la preparatoria de Peter y la verdadera identidad de Ghost-Spider.

**EN PETER PARKER**

Bugle photographer and the guy behind THAT mask...

**FR PETER PARKER**

Le photographe du Bugle et le gars derrière LE masque...

**ES PETER PARKER**

Fotógrafo del Bugle y el tipo que hay detrás de ESA máscara.



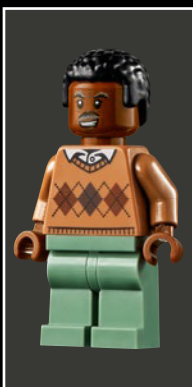

**EN** ROBBIE ROBERTSON

*Bugle* editor with a spidey-shaped soft spot.

**FR** ROBBIE ROBERTSON

Le rédacteur en chef du *Bugle* avec un petit faible pour Spider-Man.

**ES** ROBBIE ROBERTSON

Redactor del *Bugle* con debilidad por Spidey.



**EN** AUNT MAY

Peter Parker's loving (and unsuspecting) Auntie.

**FR** TANTE MAY

La tante chérie (et crédule) de Peter Parker.

**ES** TÍA MAY

La cariñosa (e ingenua) tía de Peter Parker.



**EN** BEN URICH

*Bugle* reporter. ALWAYS first with the big stories.

**FR** BEN URICH

Un journaliste du *Bugle*. TOUJOURS champion des gros titres.

**ES** BEN URICH

Reportero del *Bugle*. SIEMPRE el primero cuando hay una gran historia en juego.



**EN** BLACK CAT

A nimble, cunning criminal with sticky paws.

**FR** CHATTE NOIRE

Une criminelle agile et rusée qui a du flair.

**ES** BLACK CAT

Una ágil y astuta criminal de garras afiladas.



**EN** BLADE

Fierce, merciless hunter of vampires and monsters.

**FR** BLADE

Un féroce et impitoyable chasseur de vampires et de monstres.

**ES** BLADE

Un feroz y despiadado cazador de vampiros y monstruos.



**EN** FIRESTAR

Mutant hero with ability to conjure fire.

**FR** FIRESTAR

Une héroïne mutante capable de manipuler le feu.

**ES** FIRESTAR

Una heroína mutante capaz de producir fuego.



**EN** BETTY BRANT

*Bugle* staff member and romantic interest of Peter.

**FR** BETTY BRANT

Une employée du *Bugle* et la cible de l'affection de Peter.

**ES** BETTY BRANT

Trabajadora del *Bugle* por quien Peter siente una fuerte atracción.



**EN** THE PUNISHER

Brutal, unforgiving vigilante. Bad guys beware!

**FR** LE PUNISHER

Un justicier brutal et impitoyable. Les méchants feraient mieux de fuir !

**ES** PUNISHER

El brutal e implacable vigilante. ¡Cuidado, villanos!



**EN** DAREDEVIL

Crime-fighting hero with superhuman senses.

**FR** DAREDEVIL

Un héros avec des sens surhumains.

**ES** DAREDEVIL

Un héroe de la lucha contra el crimen con sentidos sobrehumanos.



**EN** J. JONAH JAMESON

Grizzly *Bugle* editor with a Spider-Man grudge.

**FR** J. JONAH JAMESON

Le directeur grognon du *Bugle* avec une dent contre Spider-Man.

**ES** J. JONAH JAMESON

El duro redactor jefe del *Bugle*, permanentemente enojado con Spider-Man.



**EN** CIVILIANS

Bernie the cab driver  
Amber Grant  
Ron Barney

**FR** CIVILS

Bernie le chauffeur de taxi  
Amber Grant  
Ron Barney

**ES** CIVILES

Bernie el taxista  
Amber Grant  
Ron Barney



EN

# BUILDING THE BUGLE

DAILY BUGLE EXCLUSIVE INTERVIEW WITH LEGO® DESIGNER MARK JOHN STAFFORD BY BEN URICH

*Mr Stafford. Thanks for your time. You were tasked with creating the LEGO® version of the iconic Daily Bugle HQ, so beloved by fans of the so-called 'Spider-Man.' What was your approach?*

Thanks for having me, Ben. The *Bugle* tower has been part of mythos for so long. I really wanted to capture that authentic New York setting with features like the water tower, the yellow taxi and the newspaper stand. After that, I just wanted to include as many heroes and as much action as I could!

*What kind of challenges did you face in creating the Bugle?*

Well, we really wanted to show off the interior of the building in some way and show some classic *Bugle* scenes inside. There was a lot of building and rebuilding, and one day I was trying some things out and came up with the idea of the removable front windows. From that moment, everything kind of clicked (no pun intended).



**EN** Taxi and newspaper stand. **FR** Taxi et kiosque de journaux. **ES** Taxi y puesto de periódicos.



**EN** Mark showing how to remove the front windows. **FR** Mark montrant comment retirer les fenêtres avant. **ES** Mark demostrando cómo se quitan las ventanas delanteras.

FR

# CONSTRUCTION DU BUGLE

ENTREVUE EXCLUSIVE DU DAILY BUGLE AVEC LE CONCEPTEUR LEGO® MARK JOHN STAFFORD PAR BEN URICH

*M. Stafford. Merci de votre temps. Vous avez été chargé de créer une version LEGO® de l'emblématique QG du Daily Bugle, tant aimé des amateurs du dénommé « Spider-Man ». Quelle a été votre approche ?*

Merci de me recevoir, Ben. La tour du *Bugle* est un emblème depuis bien longtemps. Je voulais vraiment saisir le cadre authentique de New York avec des caractéristiques telles que le château d'eau, le taxi jaune et le kiosque de journaux. Ensuite, tout ce que je voulais, c'était d'inclure le plus de héros et d'action possible !

*Quels défis avez-vous dû relever durant la création du Bugle ?*

Nous voulions qu'il soit possible d'entrevoir l'intérieur du bâtiment et d'y observer des scènes typiques du *Bugle*. Nous avons dû construire et reconstruire plusieurs fois, puis un jour, alors que je tentais des expériences, j'ai eu l'idée d'installer des fenêtres avant amovibles. C'était la dernière pièce du casse-tête (sans vouloir faire de jeu de mots).

ES

# CONSTRUIR EL BUGLE

ENTREVISTA EXCLUSIVA DEL DAILY BUGLE CON EL DISEÑADOR DE LEGO® MARK JOHN STAFFORD, POR BEN URICH

*Sr. Stafford, gracias por su tiempo. Le encargaron la creación de la versión LEGO® de la inconfundible sede central del Daily Bugle, tan representativa para los fans del que llaman "Spider-Man". ¿Cómo se planteó resolverlo?*

Gracias por recibirme, Ben. La torre del *Bugle* ha formado parte del mito durante mucho tiempo. Quería capturar el auténtico ambiente neoyorquino mediante elementos como la torre de agua, el taxi amarillo y el puesto de periódicos. ¡Cuando lo logré, mi única preocupación fue incluir tantos héroes y tanta acción como pudiera!

*¿Qué tipo de desafíos enfrentó al crear el Bugle?*

Bueno, realmente queríamos mostrar el interior del edificio de alguna manera, además de representar varias de las clásicas escenas que tuvieron lugar dentro del *Bugle*. Después de mucho construir y reconstruir, un día, mientras probaba cosas distintas, se me ocurrió la idea de incluir ventanas delanteras removibles. A partir de ese momento, todo encajó (perdón por el chiste malo).



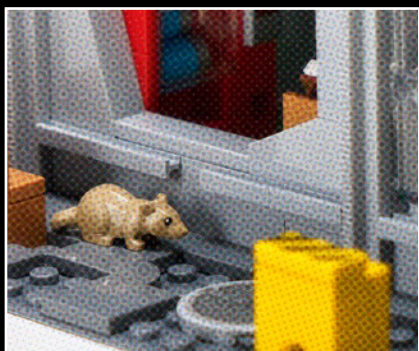

**EN** The rat in the alley. **FR** Le rat dans la ruelle. **ES** La rata del callejón.

## EN

*There's a lot for fans to love in this set – are there any hidden touches you're especially happy with?*

You'll notice a rat in the alleyway, that's a fun little call-back to the rodent who changed the course of destiny by walking across the control panel in *Avengers: Endgame*.

*And how about you? What character or element is your personal favorite?*

As a Daredevil fan, getting the green light to include the first ever LEGO® Daredevil was really exciting. I made sure he was in a prominent place, right at the front of the building, in his classic bright red suit. It's a small thing, but he's been my personal favorite for a long time, so I was very happy with that.

## FR

*Cet ensemble a beaucoup à offrir aux amateurs – y a-t-il des détails cachés dont vous êtes particulièrement fier ?*

Vous remarquerez un rat dans la ruelle; c'est une référence amusante au rongeur qui a altéré le cours du destin en marchant sur le panneau de commande dans *Avengers : Phase finale*.

*Et vous ? Quel est votre personnage ou élément favori ?*

Étant amateur de Daredevil, j'ai été enchanté de recevoir la permission d'inclure le premier Daredevil LEGO®. Je me suis assuré de le placer bien en évidence, devant le bâtiment, dans son costume rouge vif classique. Ce n'est rien de majeur, mais ça m'a fait énormément plaisir, puisqu'il est mon personnage préféré depuis très longtemps.

## ES

*El set incluye un montón de cosas para hacer felices a los fans. ¿Existe algún detalle secreto del que esté especialmente satisfecho?*

Hay una rata en el callejón. Es un gracioso detalle relacionado con el roedor que cambia el curso del destino al recorrer el panel de control en *Avengers: Endgame*.

*¿Y qué hay de usted? ¿Qué personaje o elemento es su favorito?*

Como fan de Daredevil, recibir el visto bueno para incluir al primer Daredevil LEGO®



**EN** Scenes inside the building. **FR** Scènes à l'intérieur du bâtiment. **ES** Escenas dentro del edificio.

de la historia fue muy emocionante. Me aseguré de que estuviera en un lugar destacado, justo en la parte delantera del edificio, con su clásico traje rojo intenso. No es gran cosa, pero fue mi personaje favorito durante mucho tiempo, así que aquello me hizo muy feliz.



**EN** Exclusive minifigures and Daredevil. **FR** Figurines exclusives et Daredevil. **ES** Minifiguras exclusivas y Daredevil.



**EN** Mark separates the building. **FR** Mark sépare le bâtiment. **ES** Mark separa el edificio.





**EN** Mark showing the pile of LEGO® bricks he did stickers for. **FR** Mark montrant la pile de briques LEGO® pour lesquelles il a fait des autocollants. **ES** Mark muestra los numerosos bricks LEGO® para los que creó calcomanías.

## EN HEADLINE NEWS

INTERVIEW WITH LEGO® GRAPHIC  
DESIGNER **MARK TRANTER**

"I'm a true Spider-Man fan, so I wanted to get as much of that universe into this set as possible. Fans will really enjoy the little jokes and references to classic stories – like the clone epidemic or Norman Osborne running for Mayor. With each of the main characters in the set I wanted to

hint towards their backstory, so Daredevil has "Nelson and Murdoch" and Blade has "Vampires Spotted on the Subway" which is one of my personal favorites!"





ES

# TITULARES

ENTREVISTA CON EL DISEÑADOR GRÁFICO DE LEGO®: **MARK TRANTER**

"Soy un verdadero fan de Spider-Man, así que me esforcé por incluir tanto como pudiera de su universo en el set. A los fans les encantarán las pequeñas bromas y referencias a las historias clásicas (como la epidemia de clones o la candidatura de Norman Osborne a la alcaldía). Quise dejar pistas de la biografía de cada uno de los personajes que protagonizan el set. Así, el bufete de abogados Nelson y Murdock es una clara alusión a Daredevil, mientras que el noticiero de televisión sobre el avistamiento de vampiros en el metro, uno de mis detalles favoritos, evidentemente se refiere a Blade".

EN Newspaper decorations. FR Décorations de journaux. ES Portadas de periódicos.

FR

# MANCHETTES

ENTREVUE AVEC LE GRAPHISTE LEGO® **MARK TRANTER**

« Je suis un grand amateur de Spider-Man, alors je voulais que cet ensemble comprenne le plus d'éléments de cet univers possible. Les amateurs apprécieront les blagues et les références à des histoires classiques – comme l'épidémie de clones ou Norman Osborne qui entre dans la course à la mairie. Je voulais inclure une allusion au passé de chaque personnage dans cet ensemble, alors Daredevil a "Nelson et Murdock" et Blade a "Vampires aperçus dans le métro", qui est l'une de mes préférées ! »

EN Vampire stickers for the TV.

FR Autocollants de vampires pour la télé.

ES Calcomanías sobre el avistamiento de vampiros para el televisor.





**DAILY  BUGLE**

**STOP THE PRESSES!  
ON ARRÊTE TOUT !  
¡PAREN LAS PRENSAS!**

**IT'S TIME TO FOLLOW THE INSTRUCTIONS AND CREATE THE STORY OF THE YEAR!  
C'EST LE MOMENT DE SUIVRE LES INSTRUCTIONS ET DE CRÉER L'HISTOIRE DE L'ANNÉE !  
¡ES HORA DE QUE SIGAS LAS INSTRUCCIONES Y CREES LA HISTORIA DEL AÑO!**

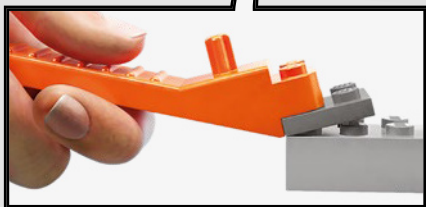
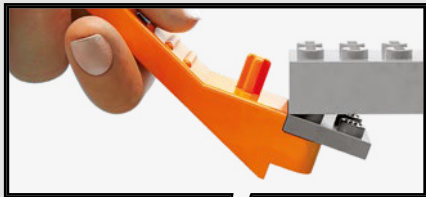



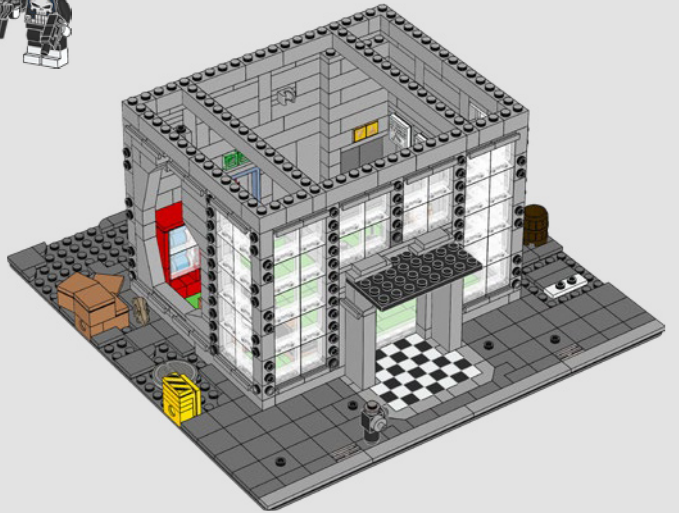

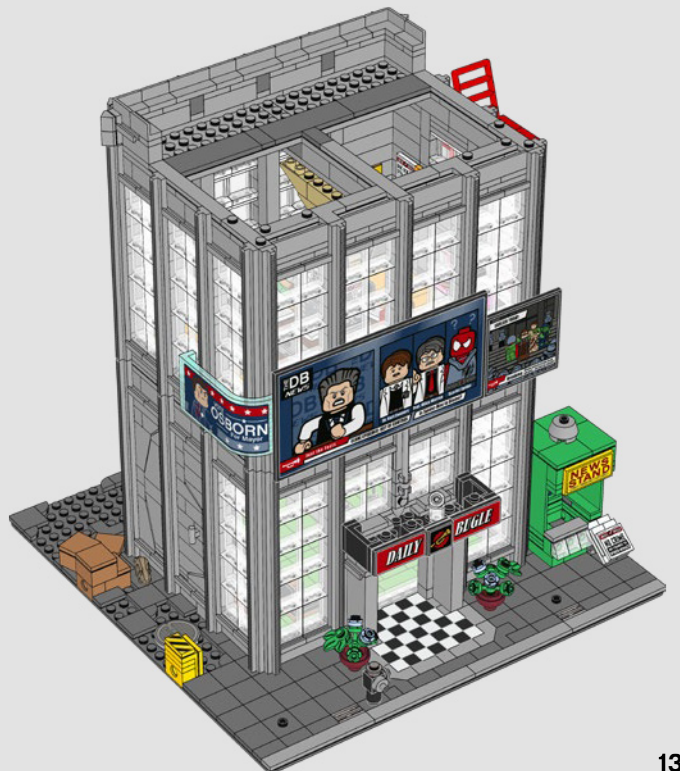
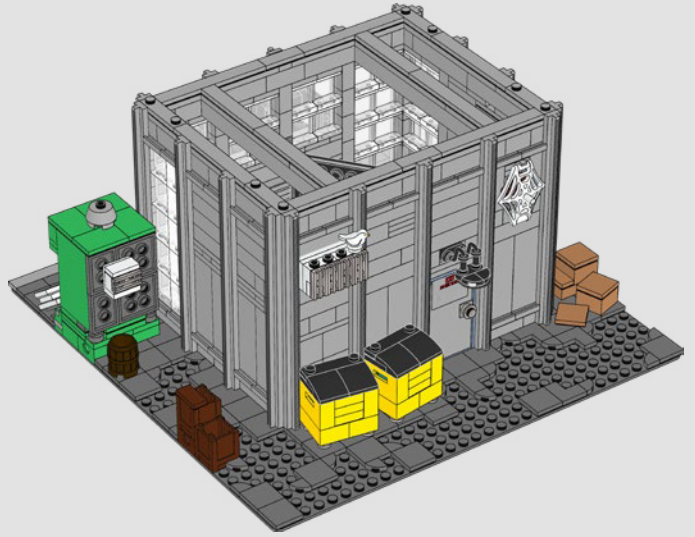
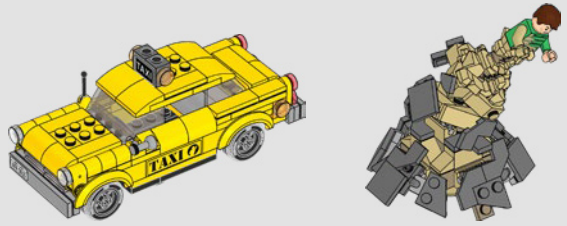









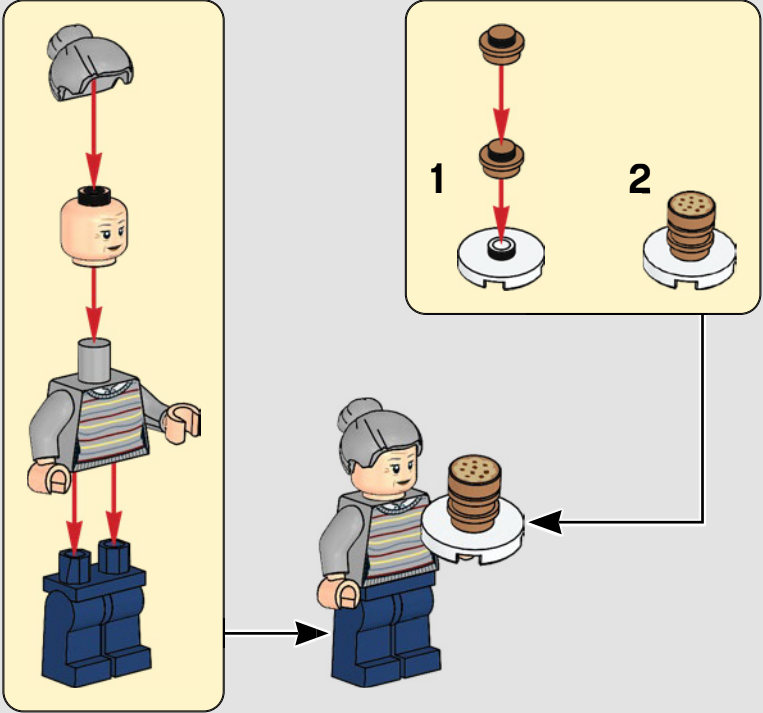
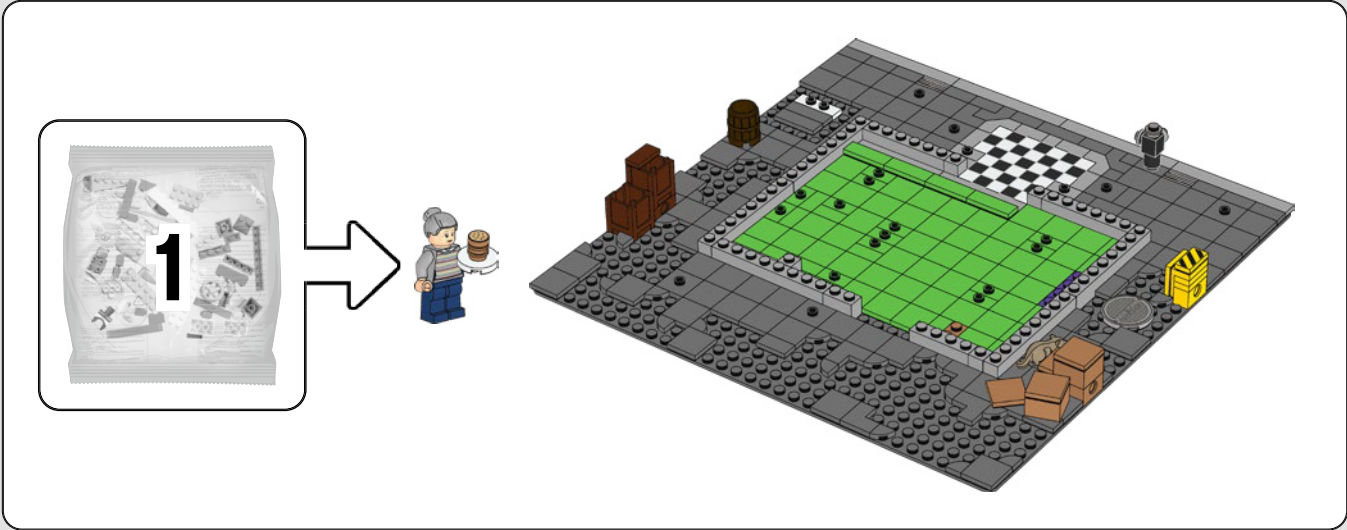

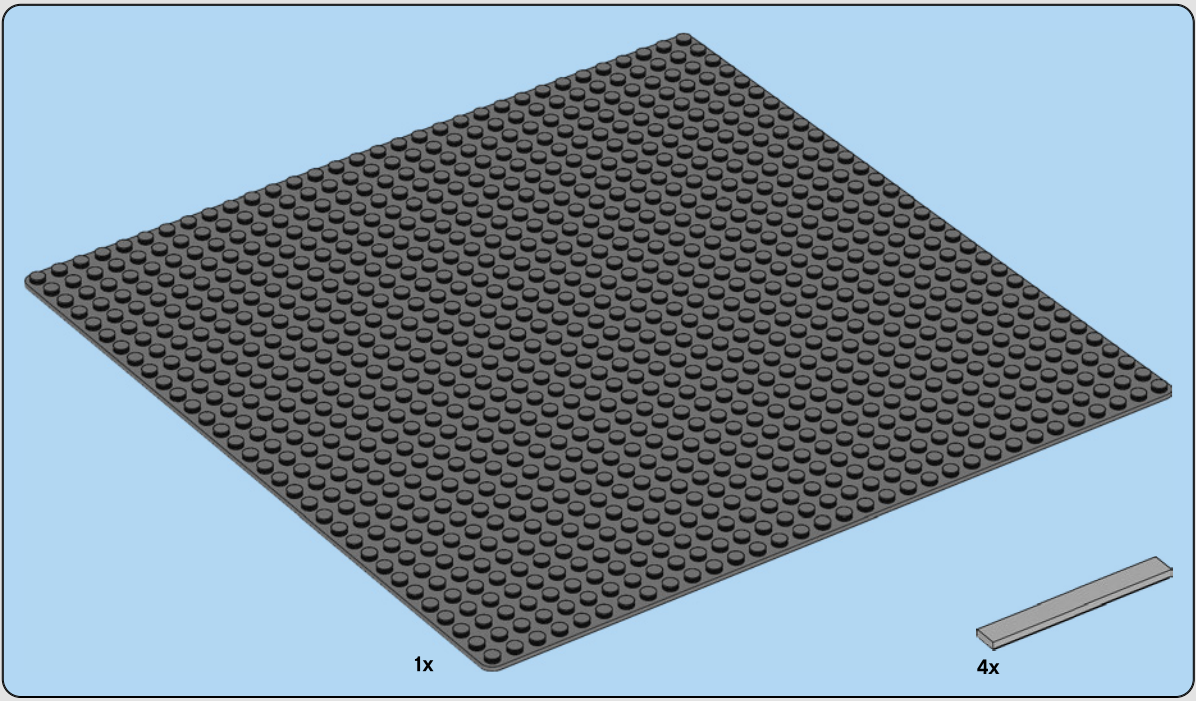

1

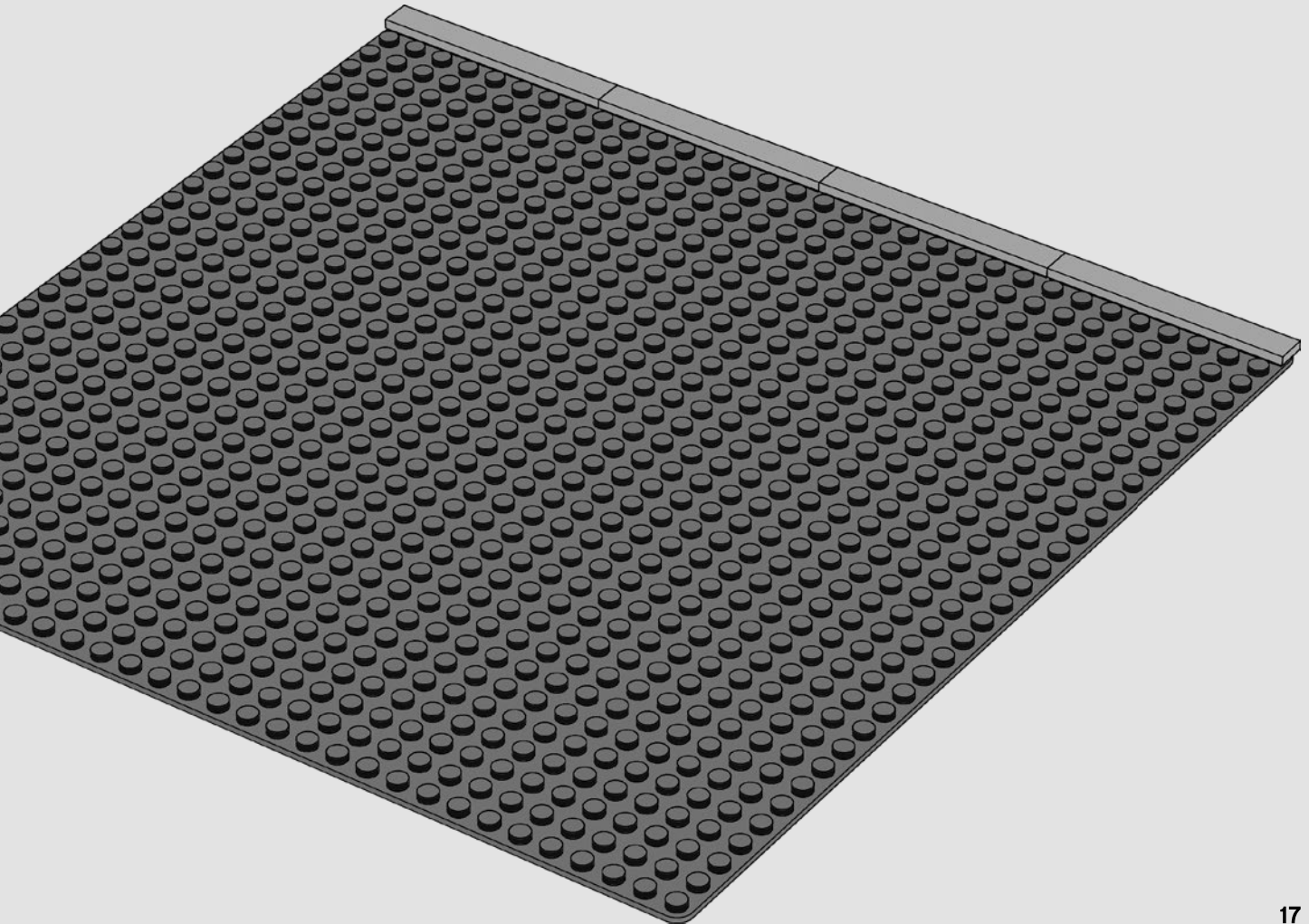



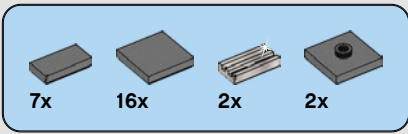

2

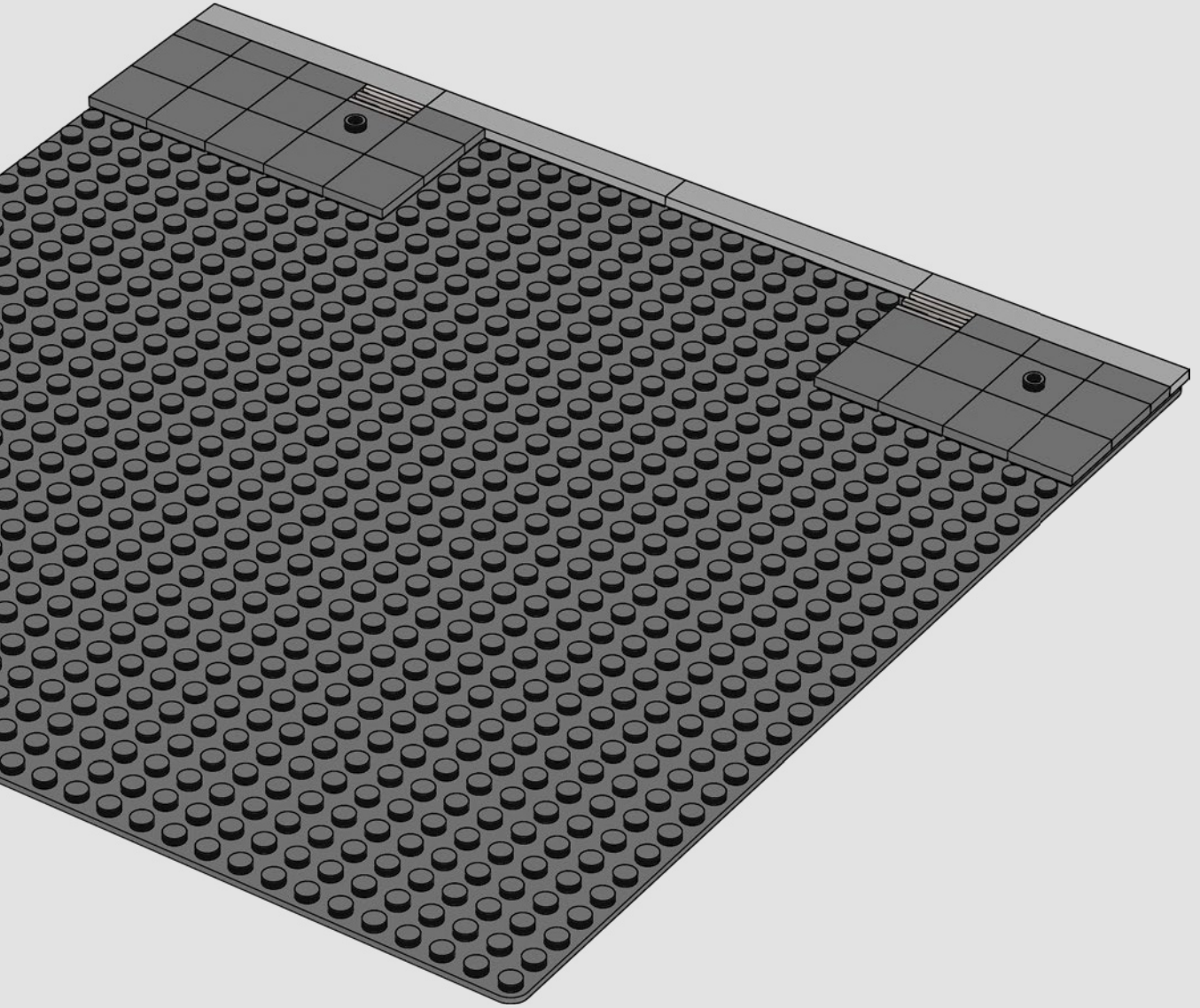

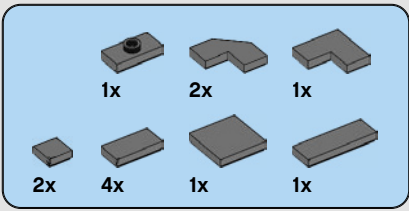

**3**

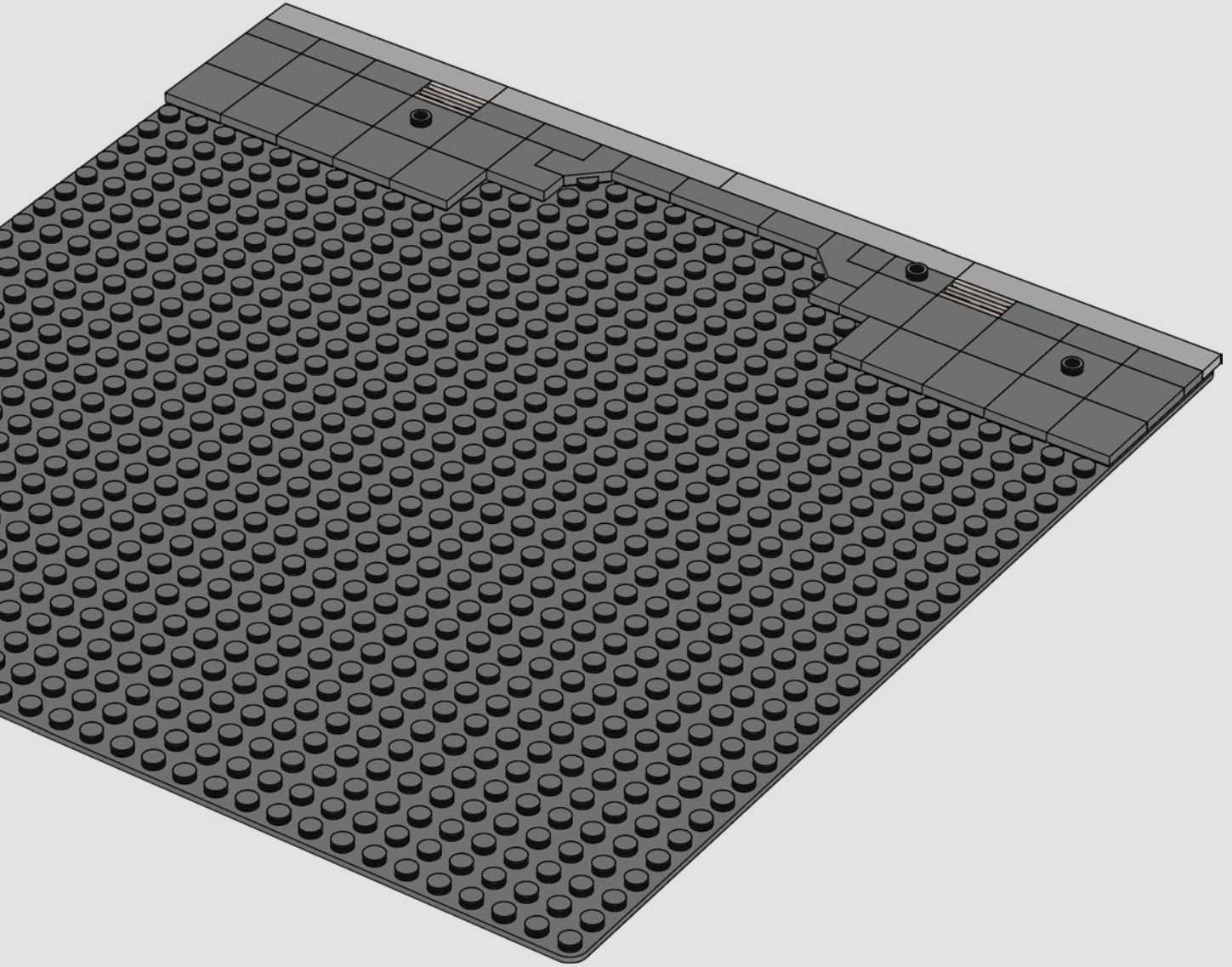



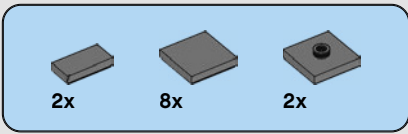

4

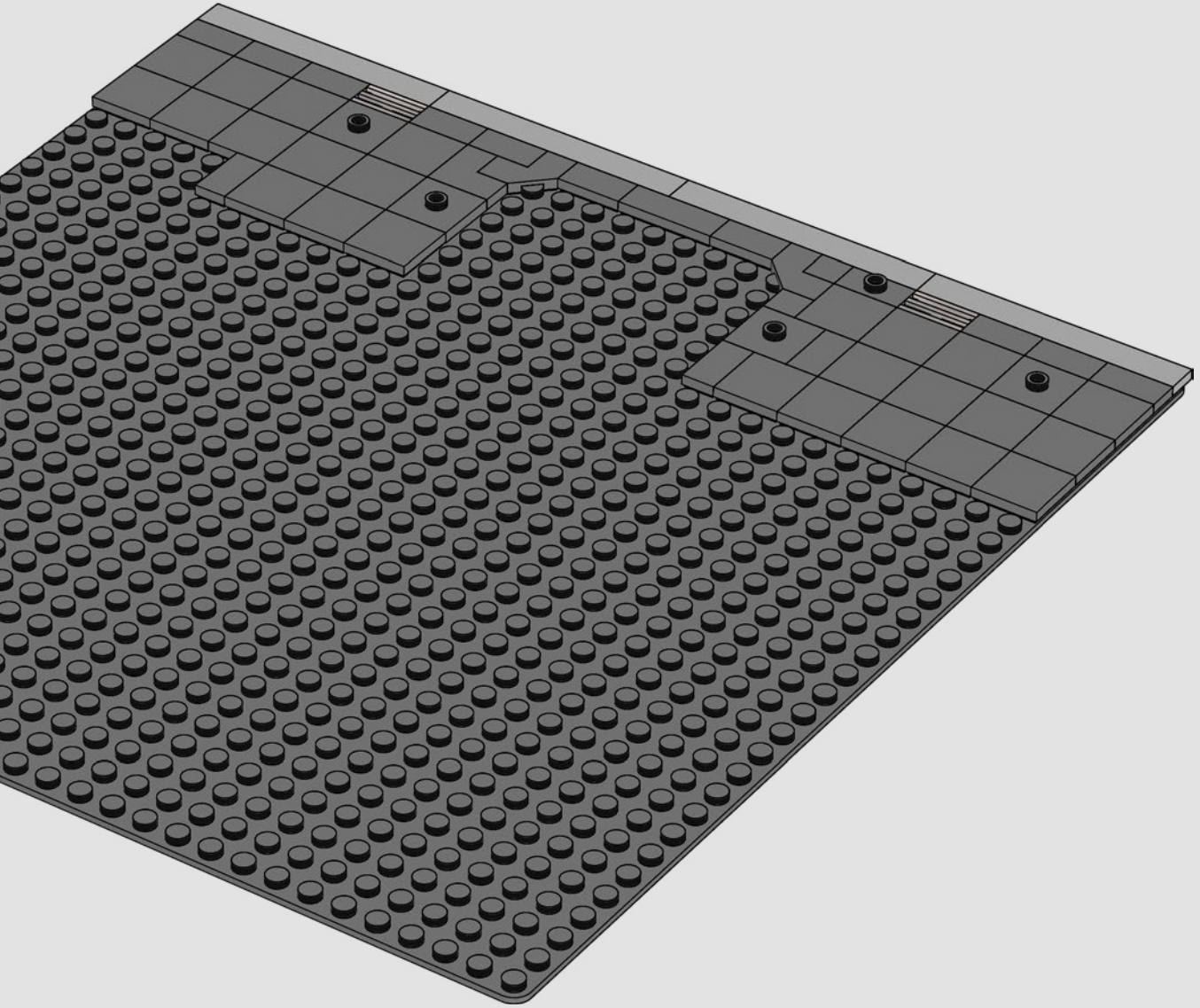

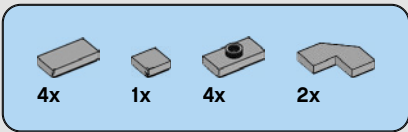

5

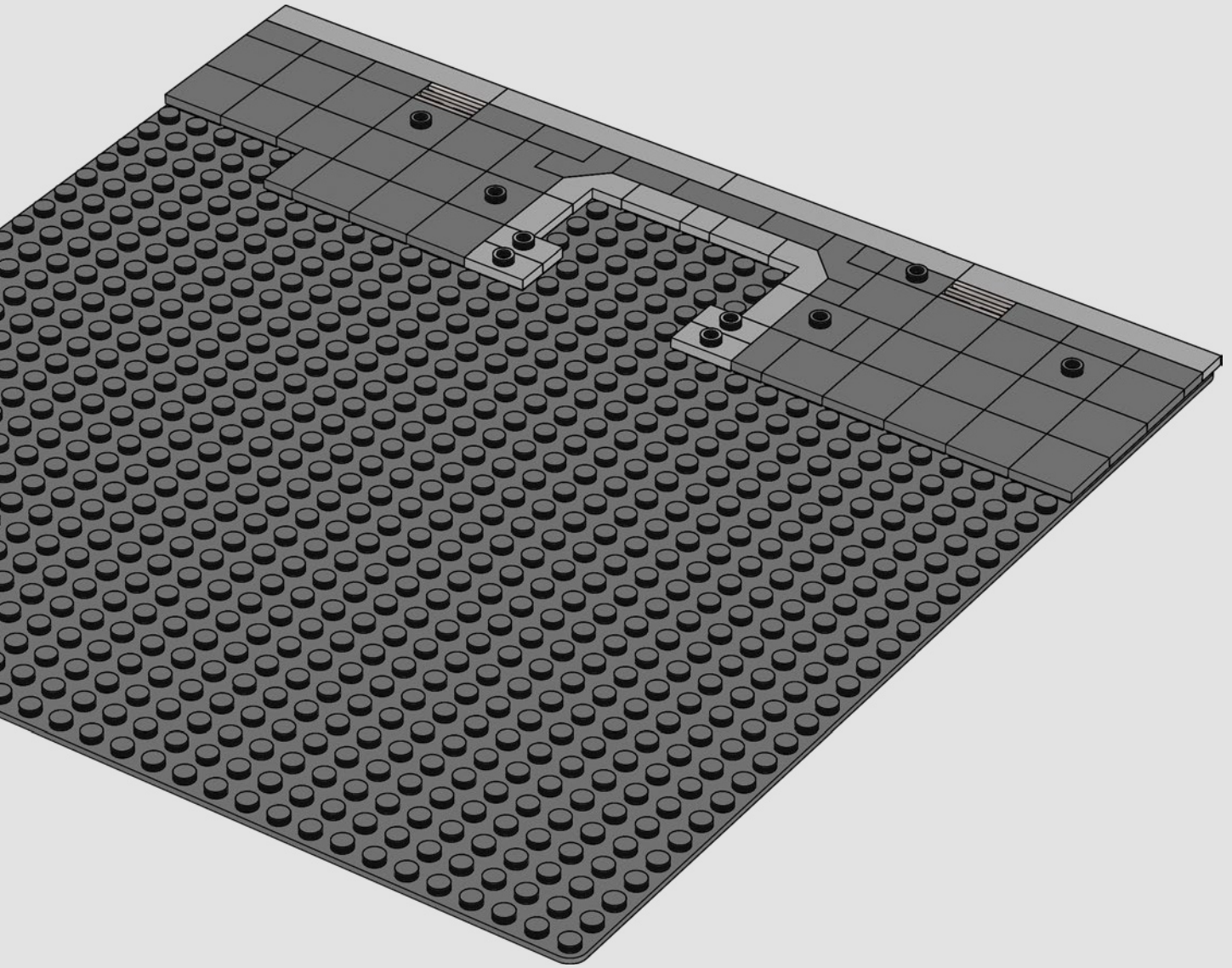





19x



17x

6

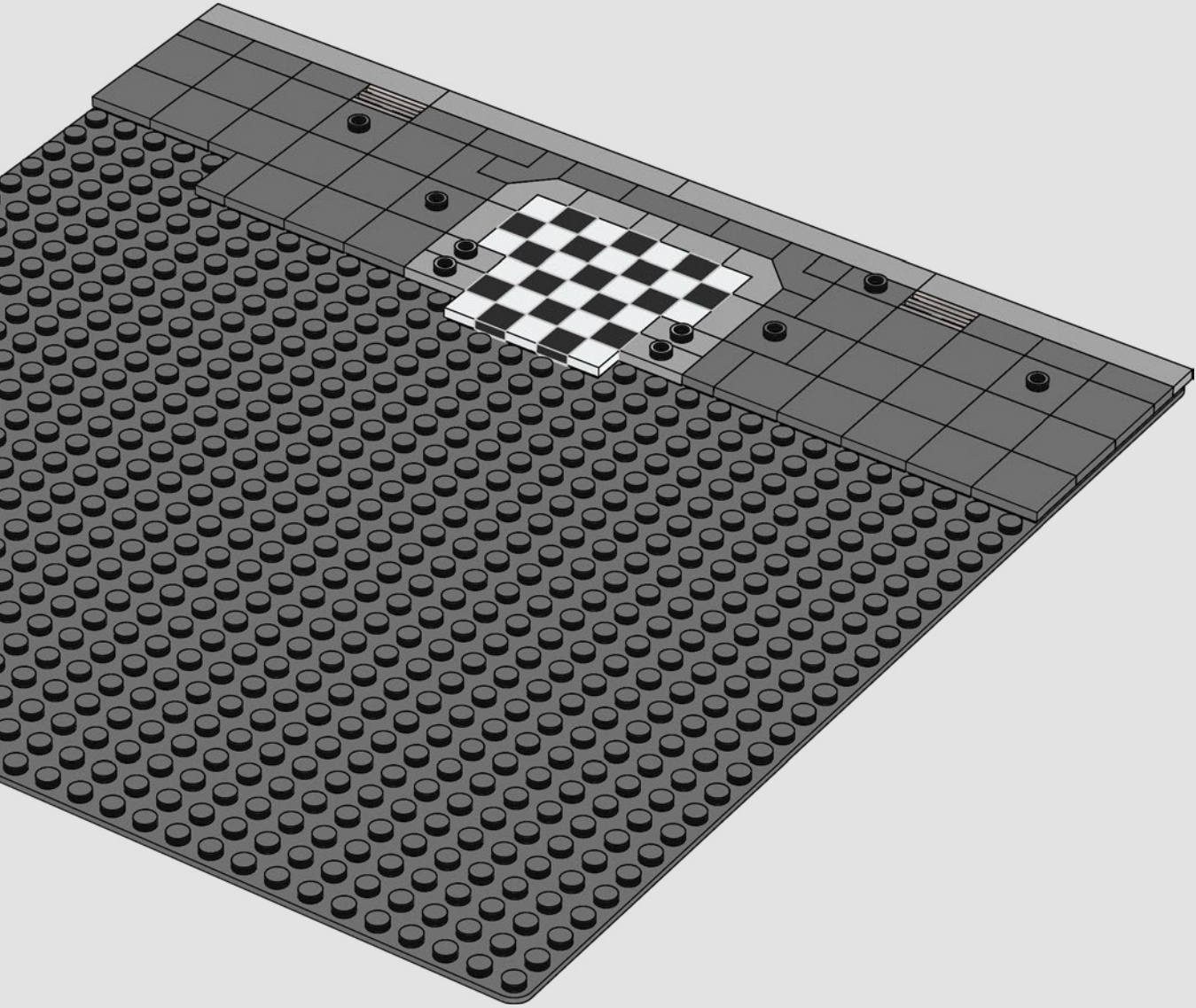

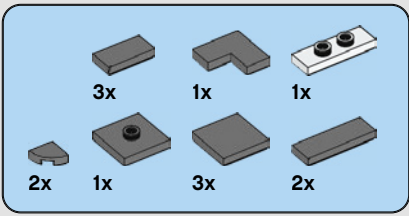

7

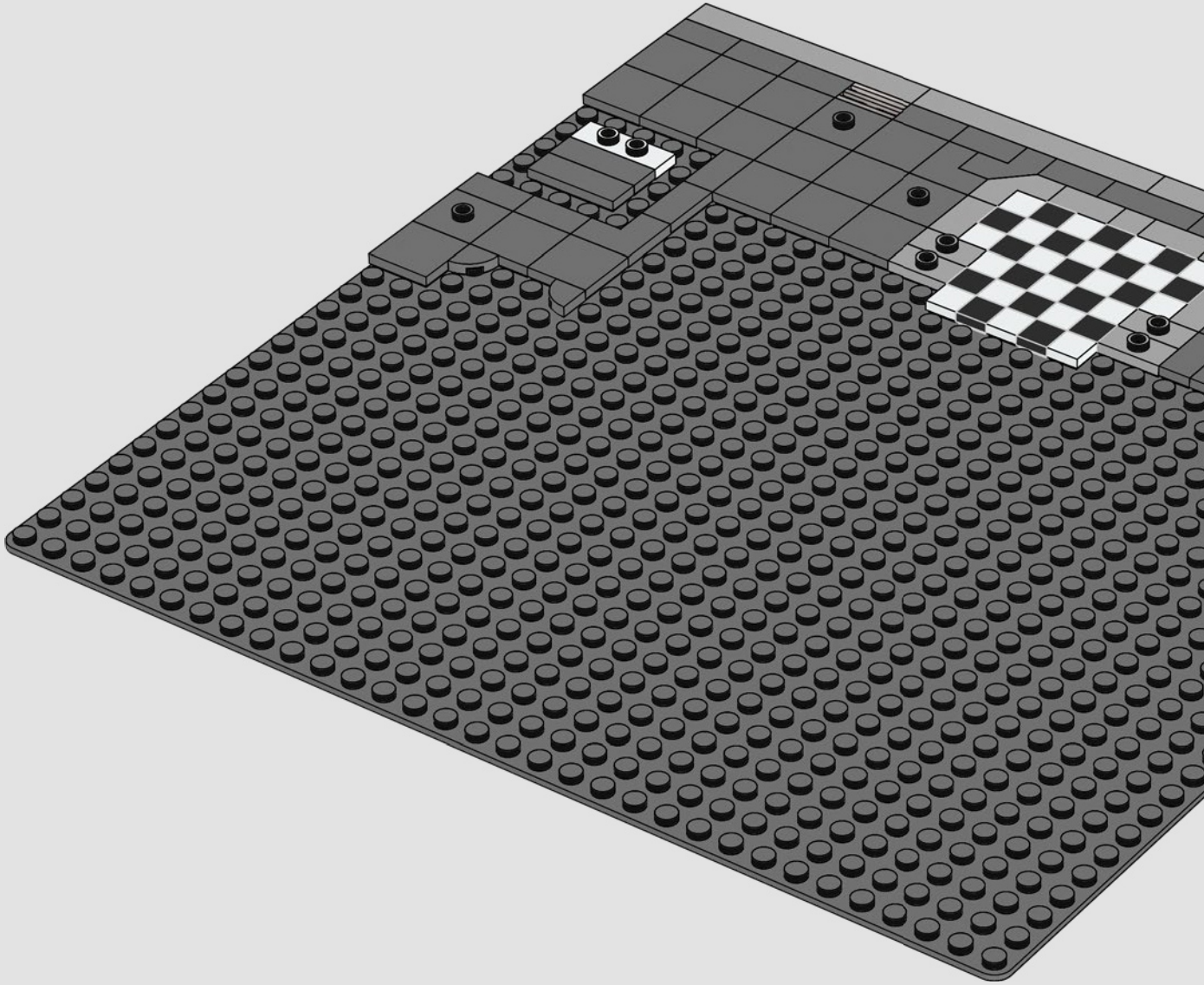



1x 6x 3x

8

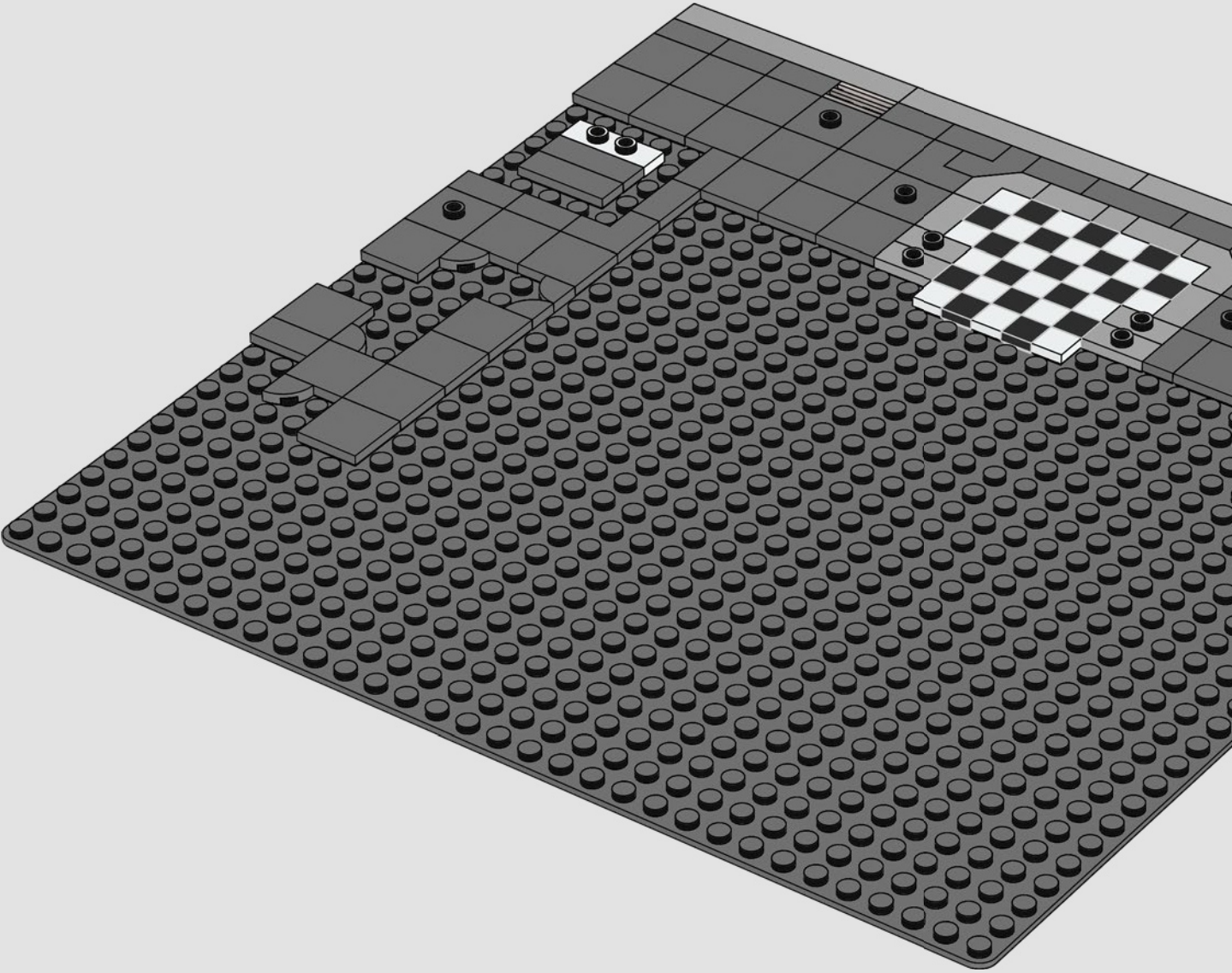

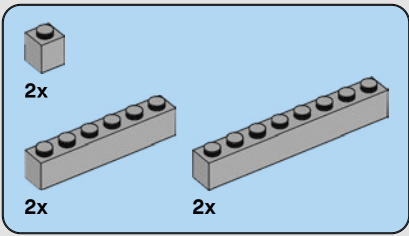

9

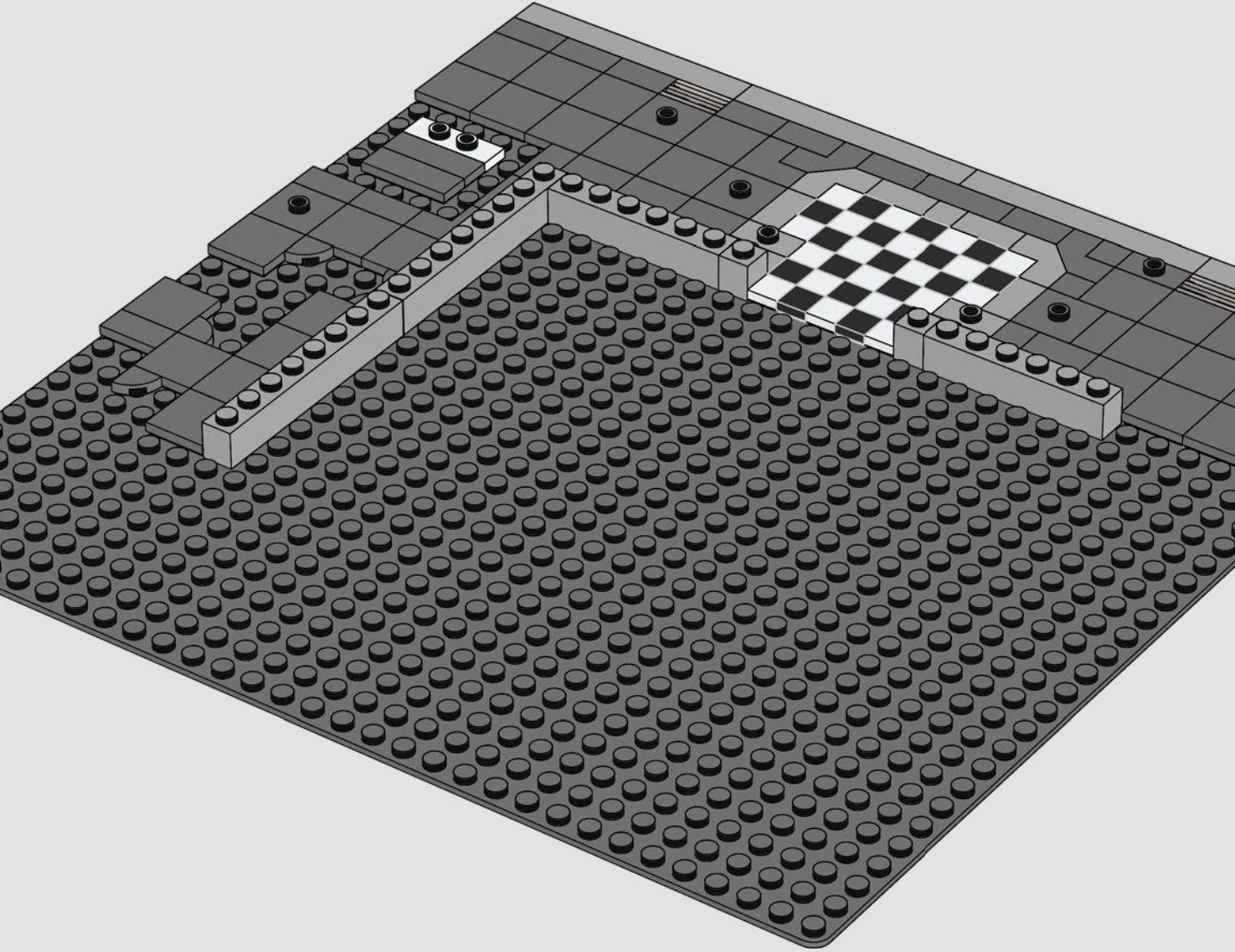



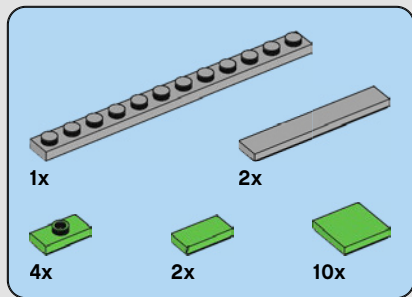

10

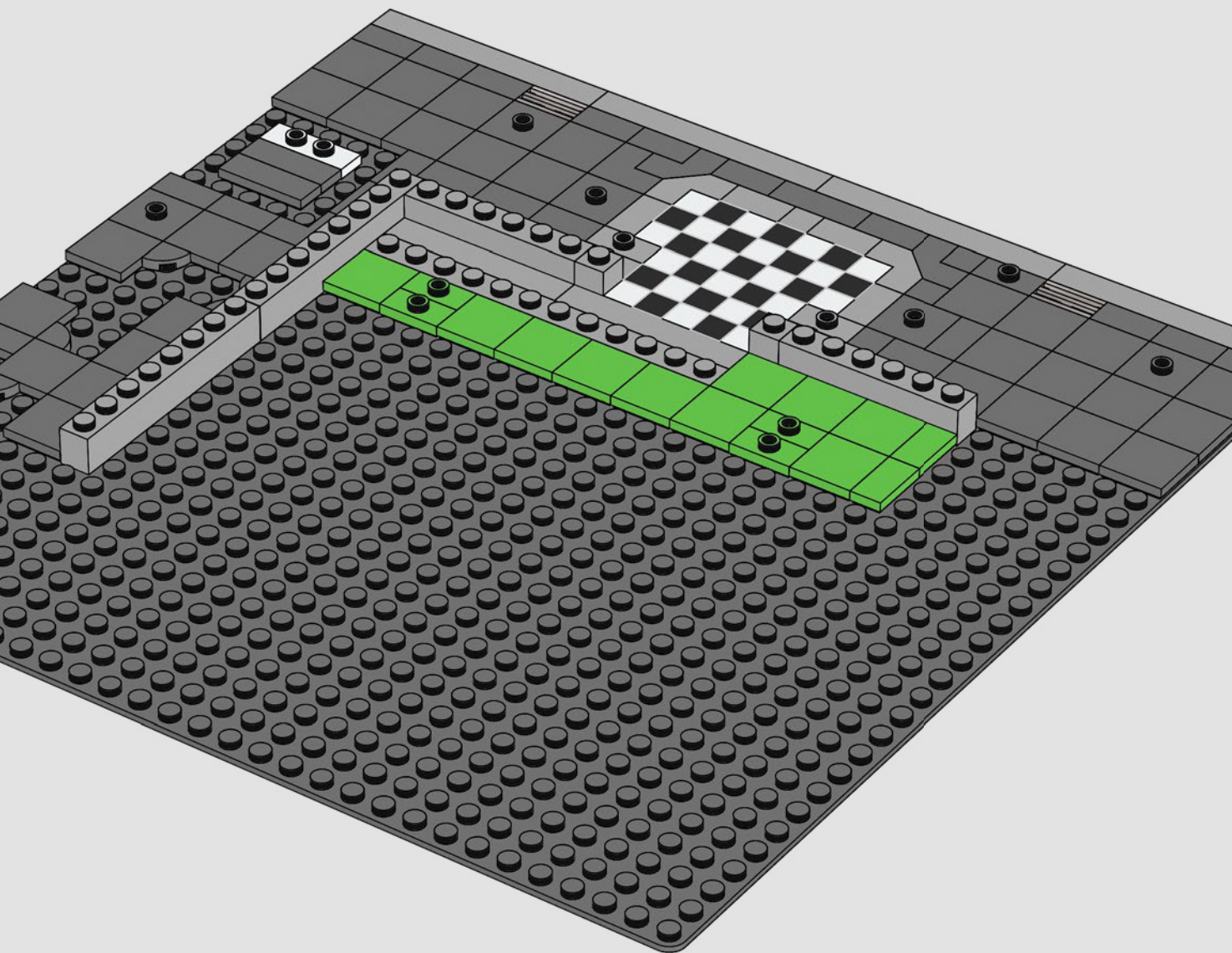

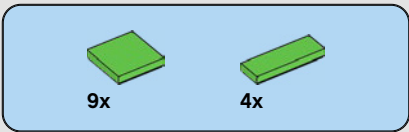

11

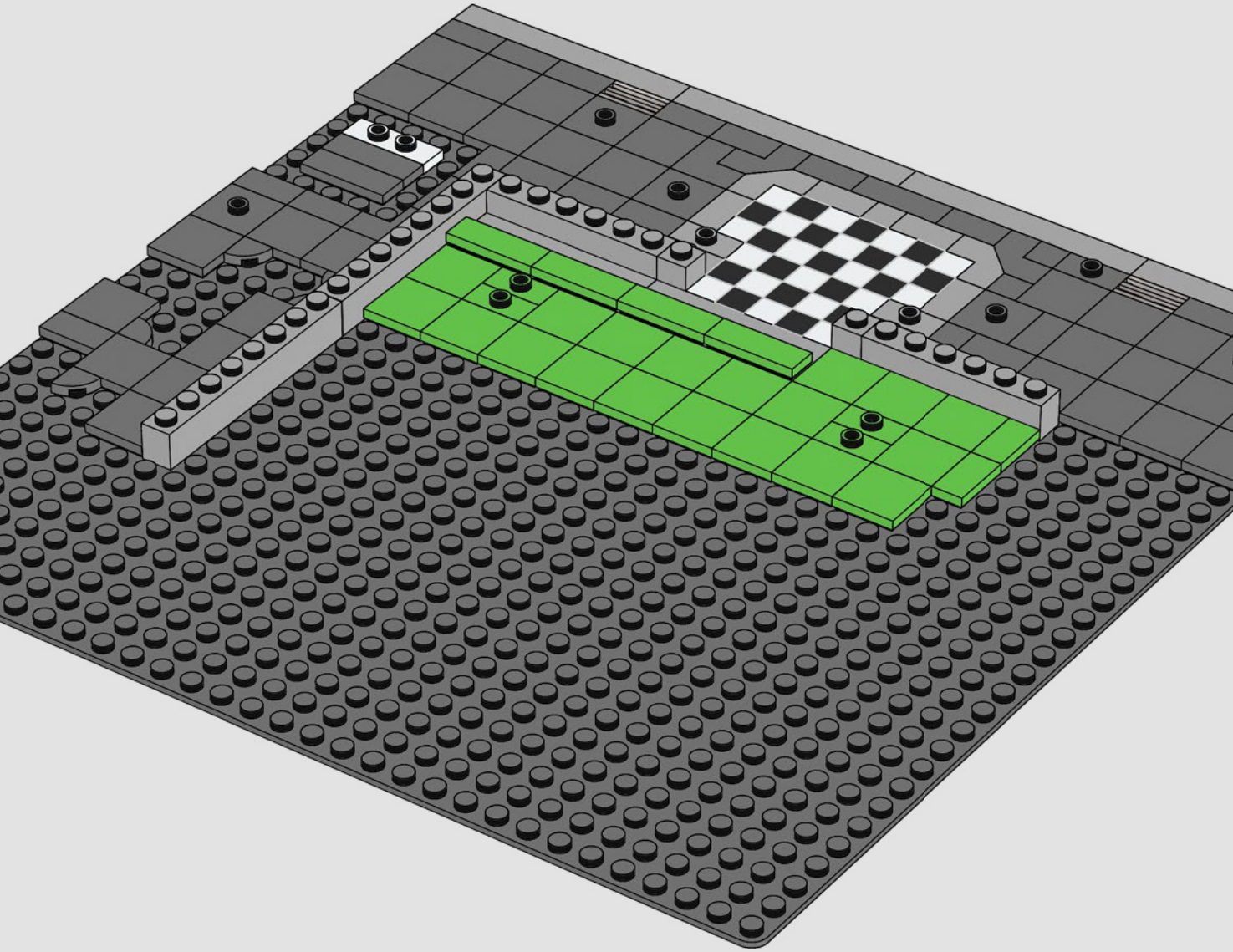



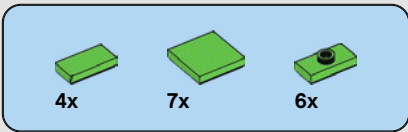

12

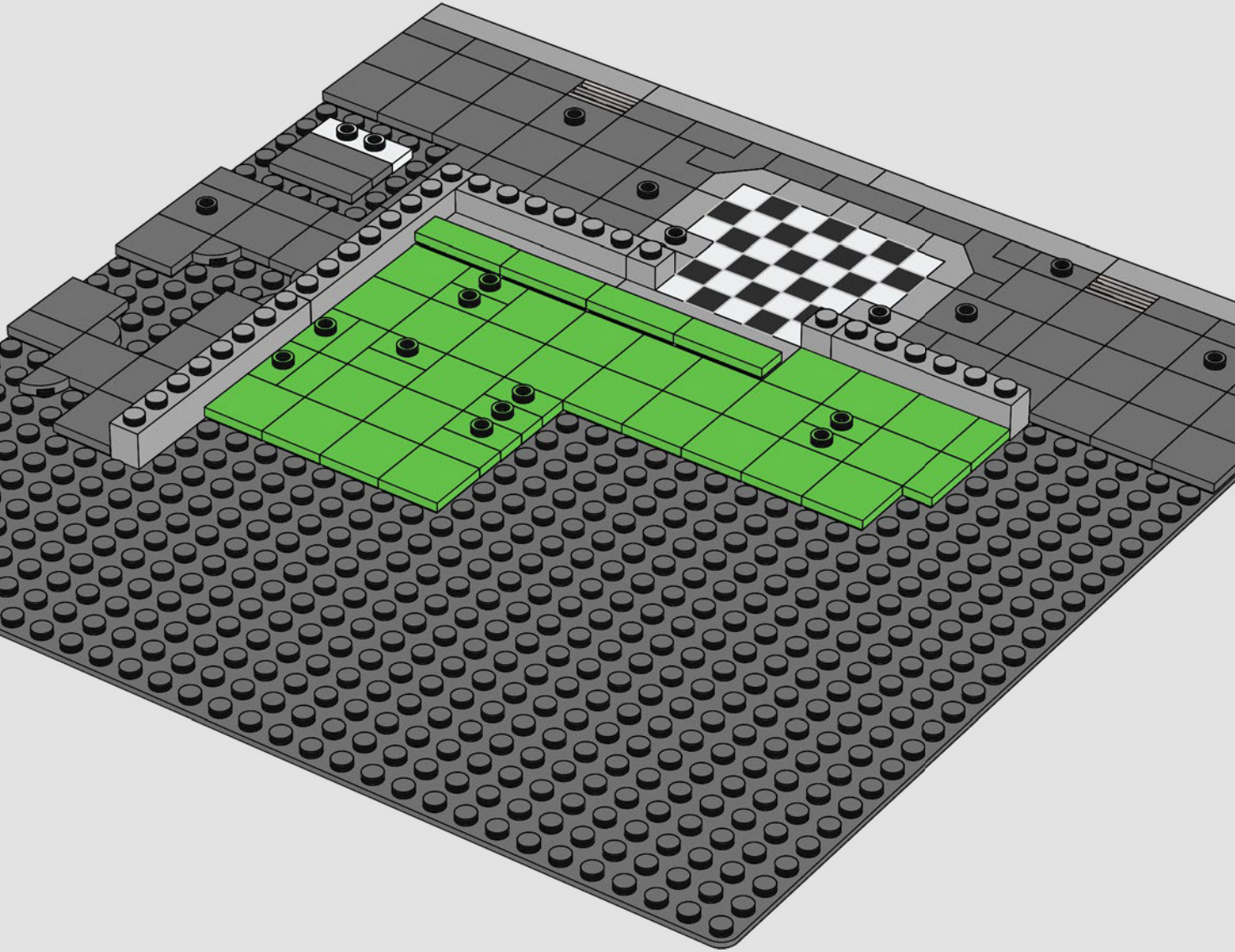

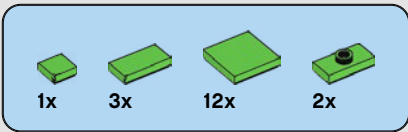

# 13

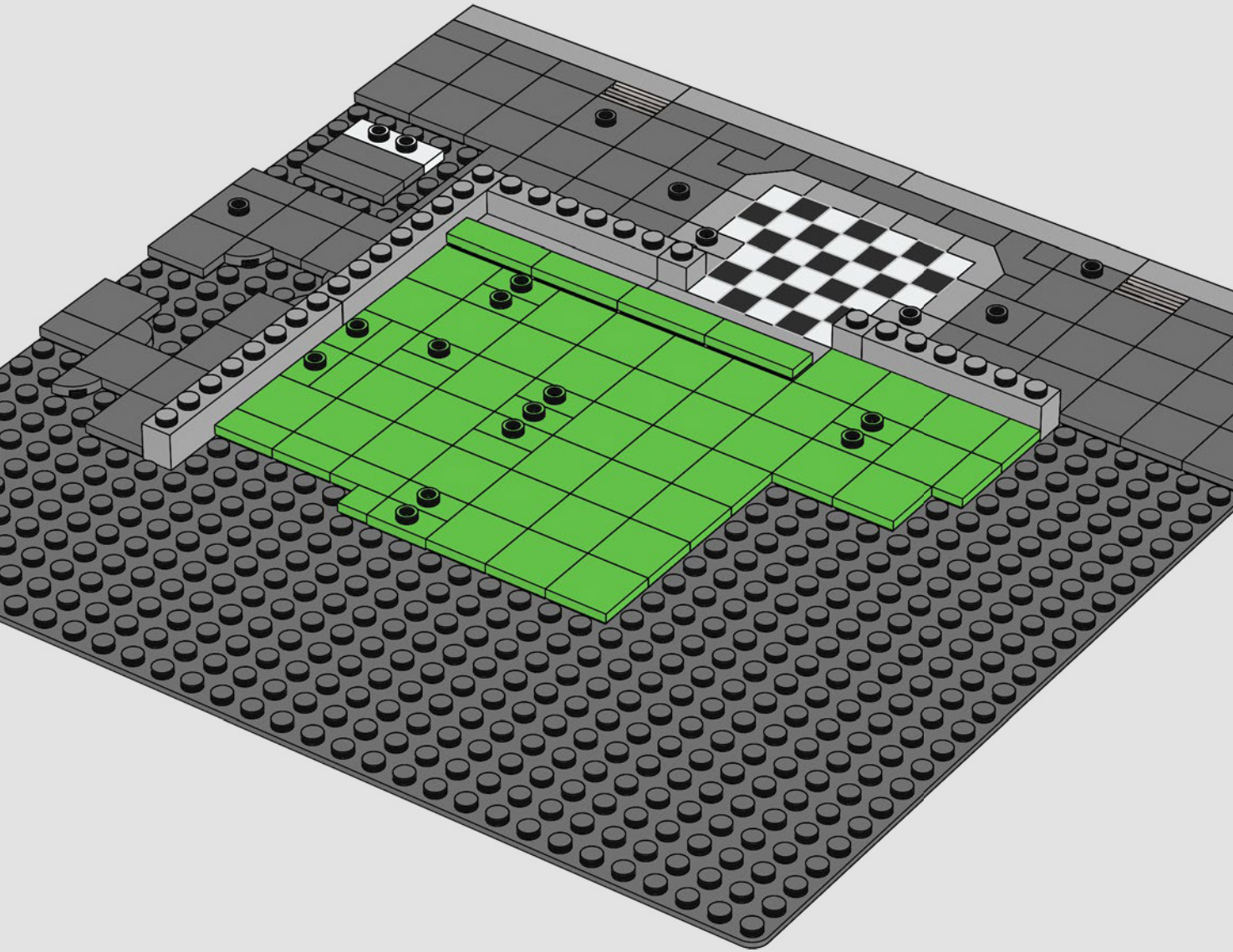



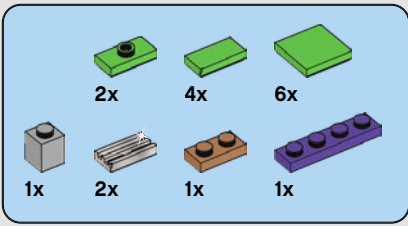

14

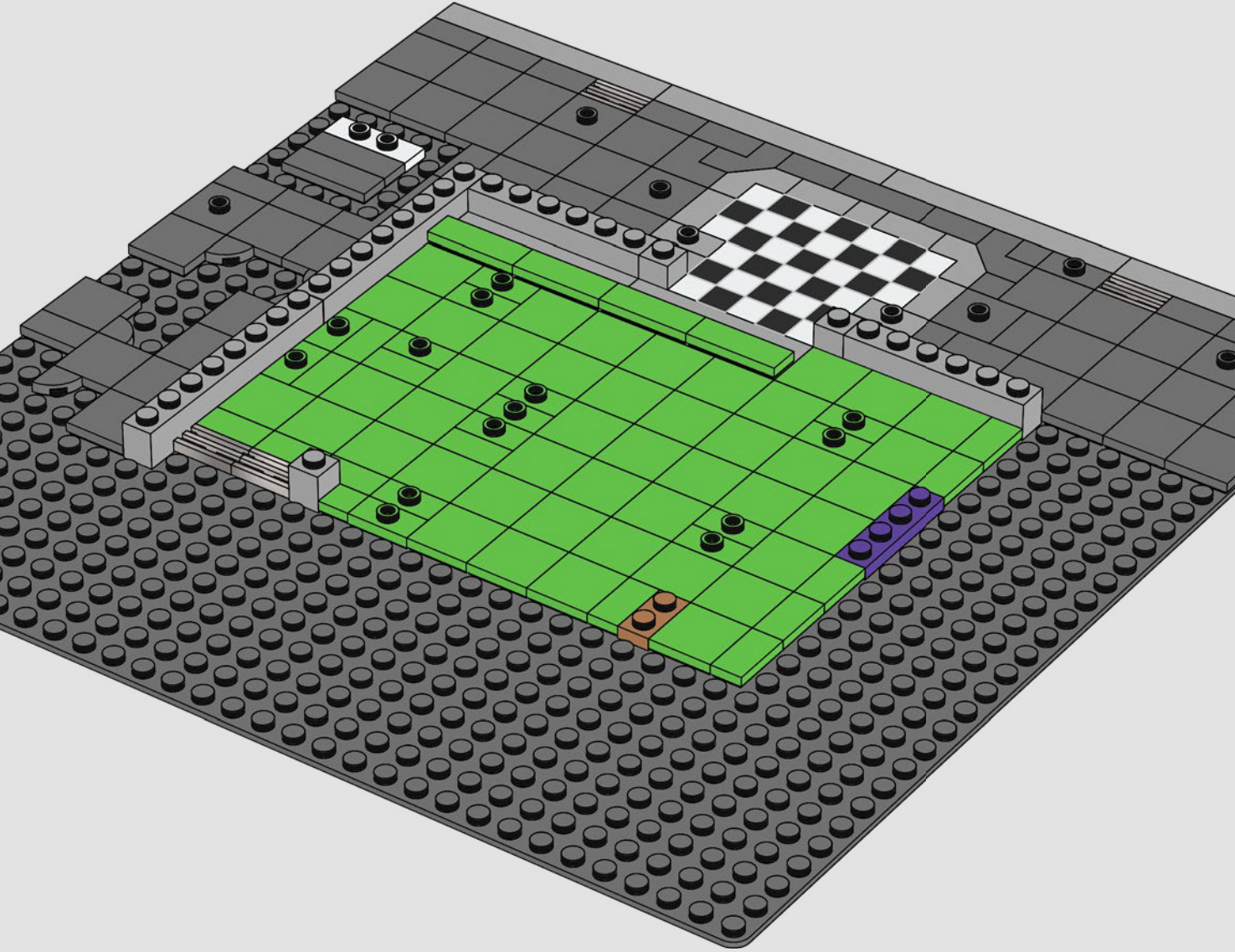

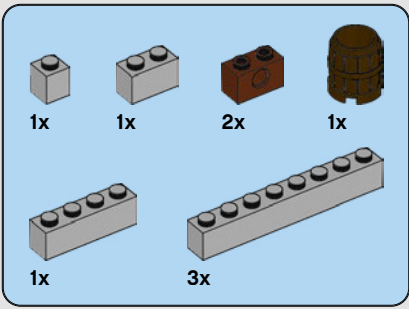

15

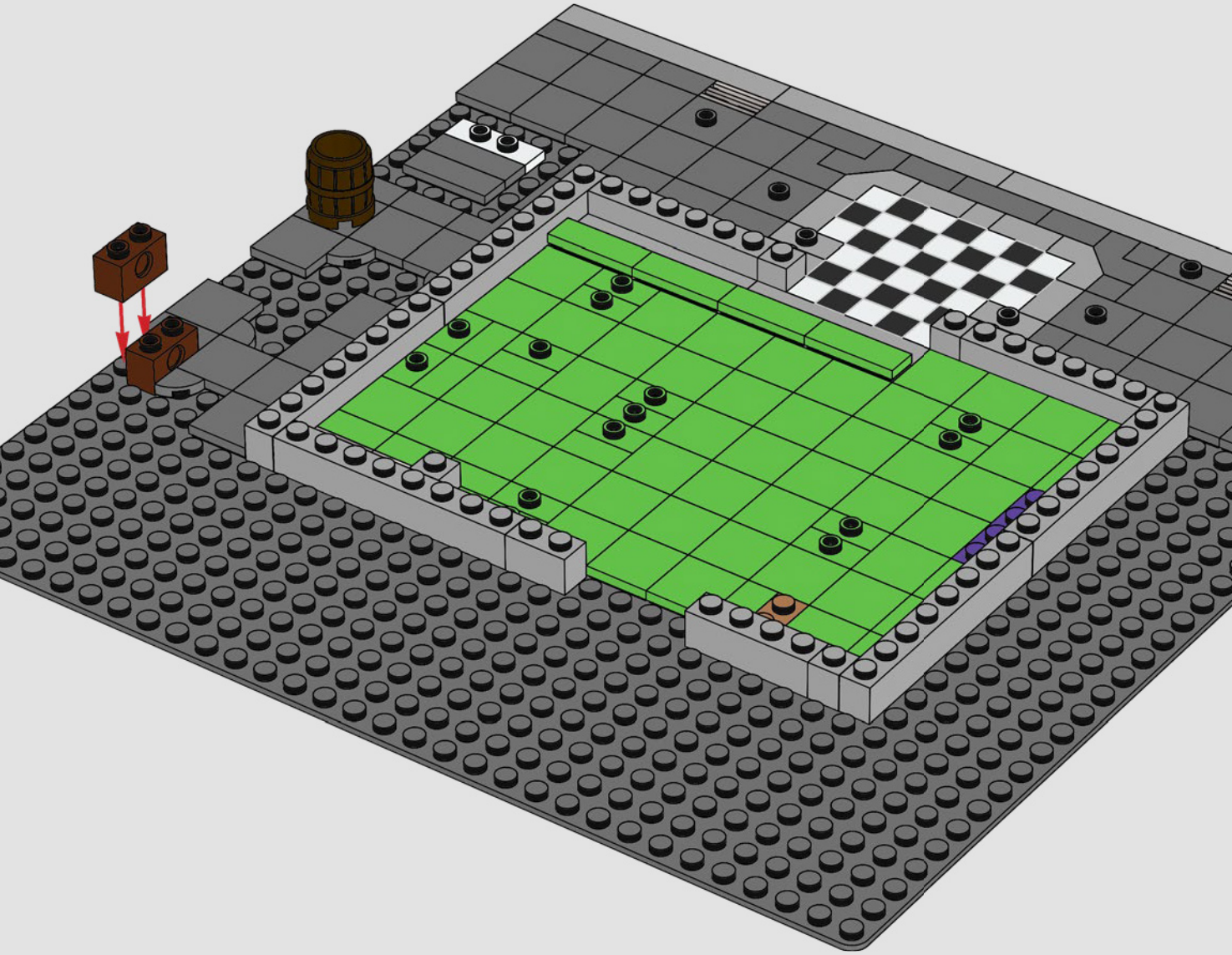



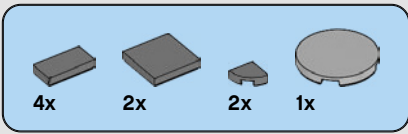

16

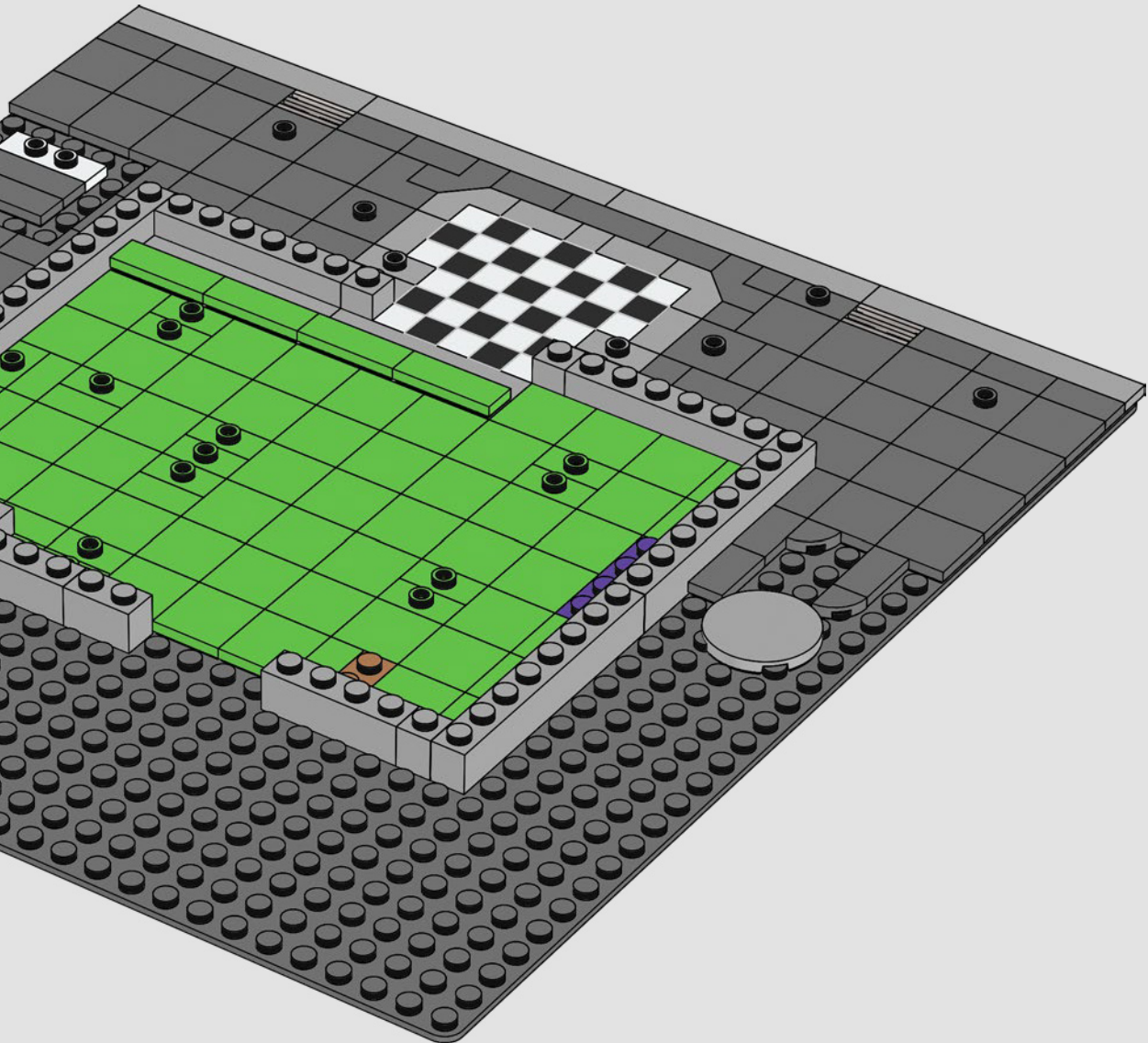

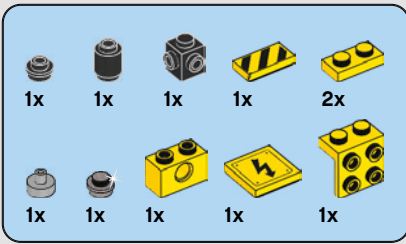

17

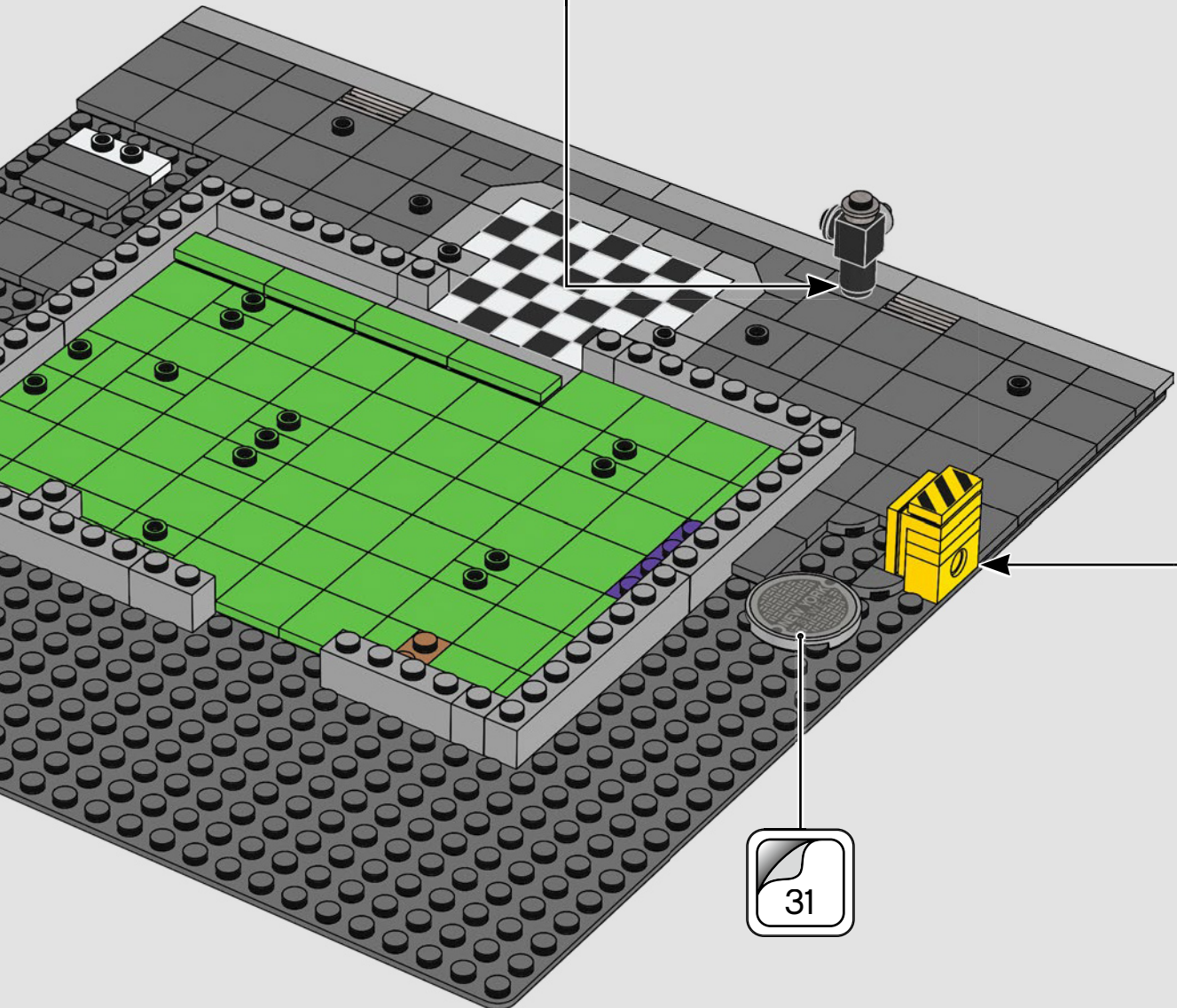
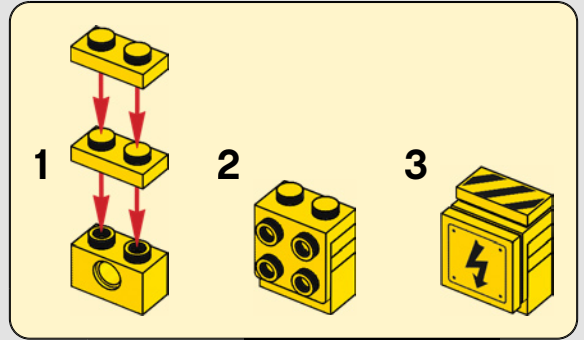
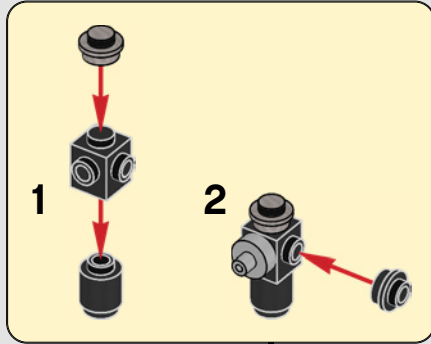









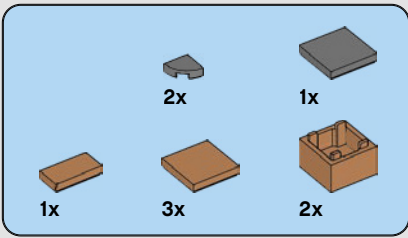

20

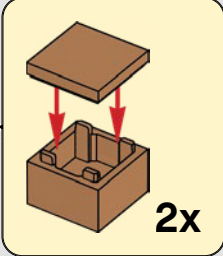
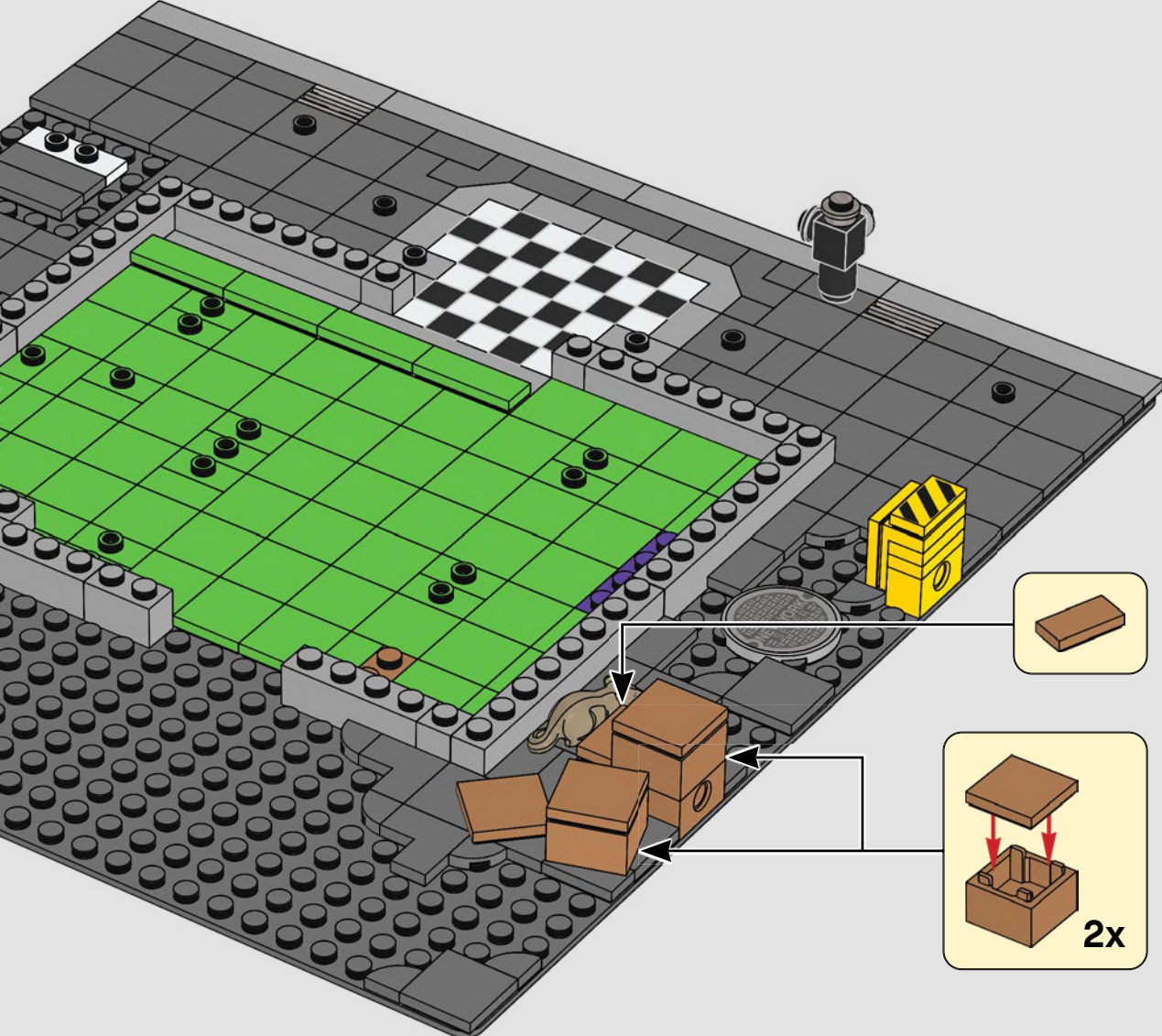

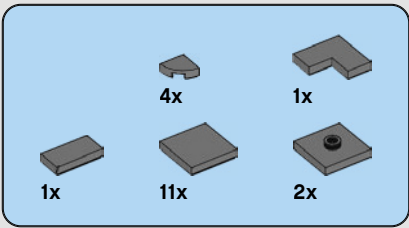

21

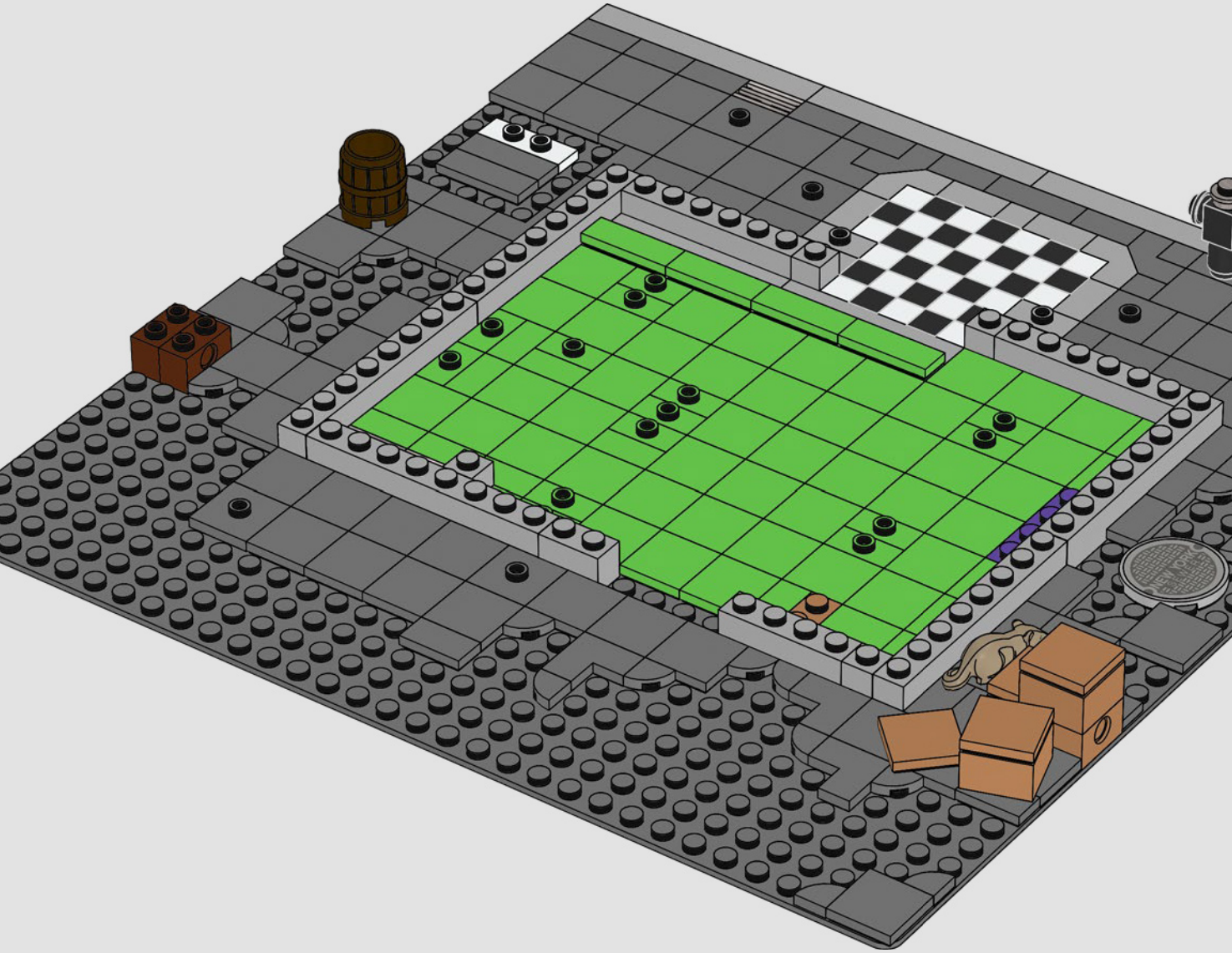



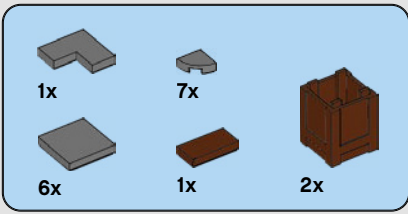

22

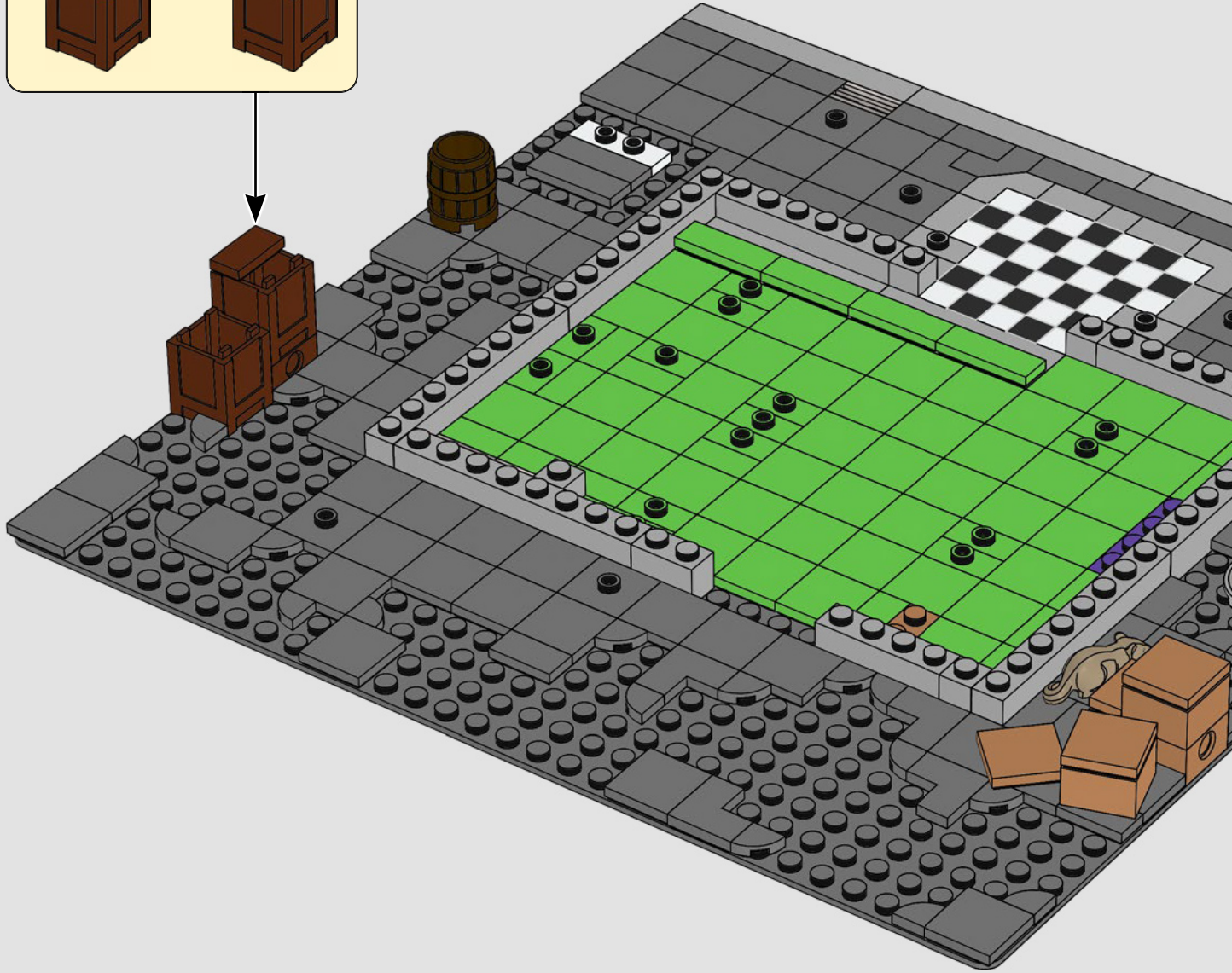
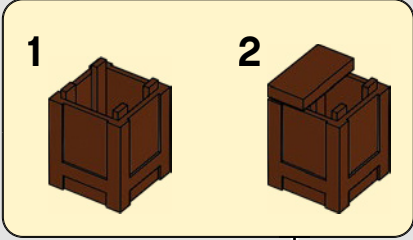

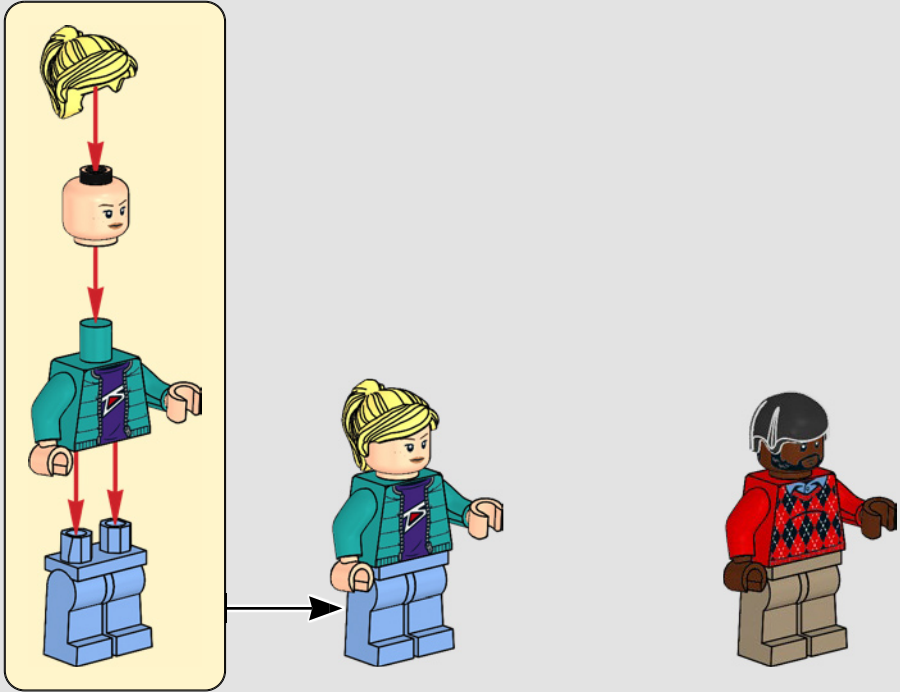
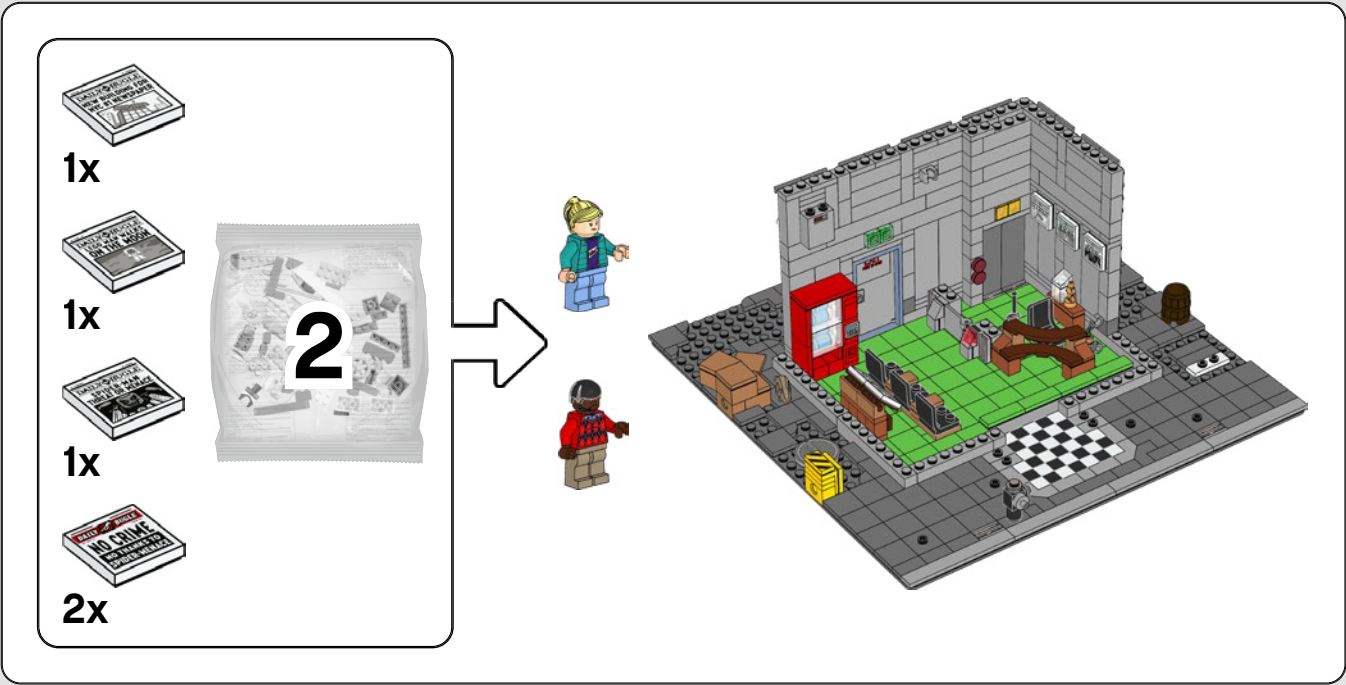



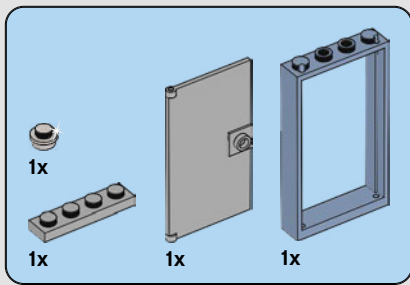

23

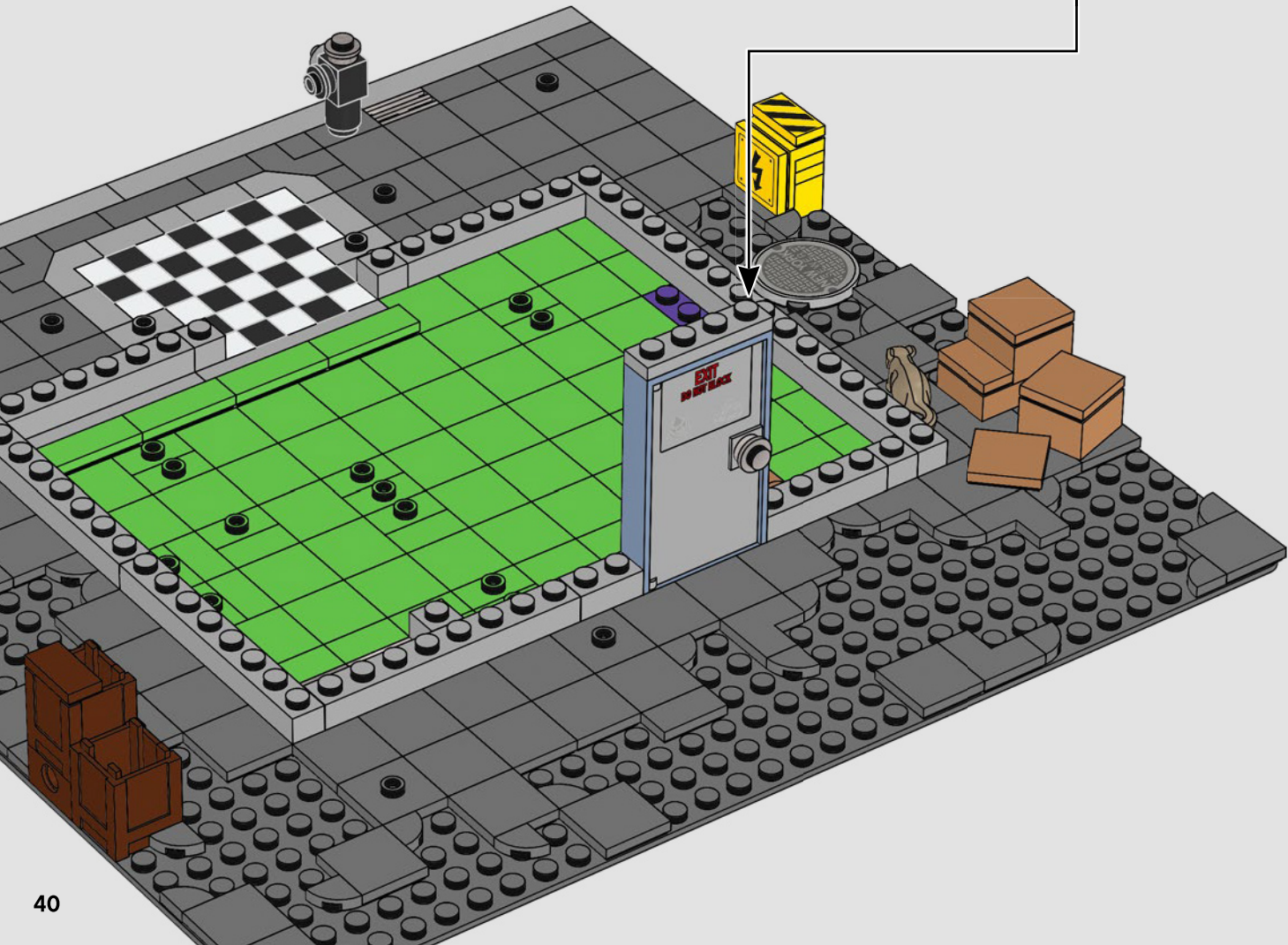
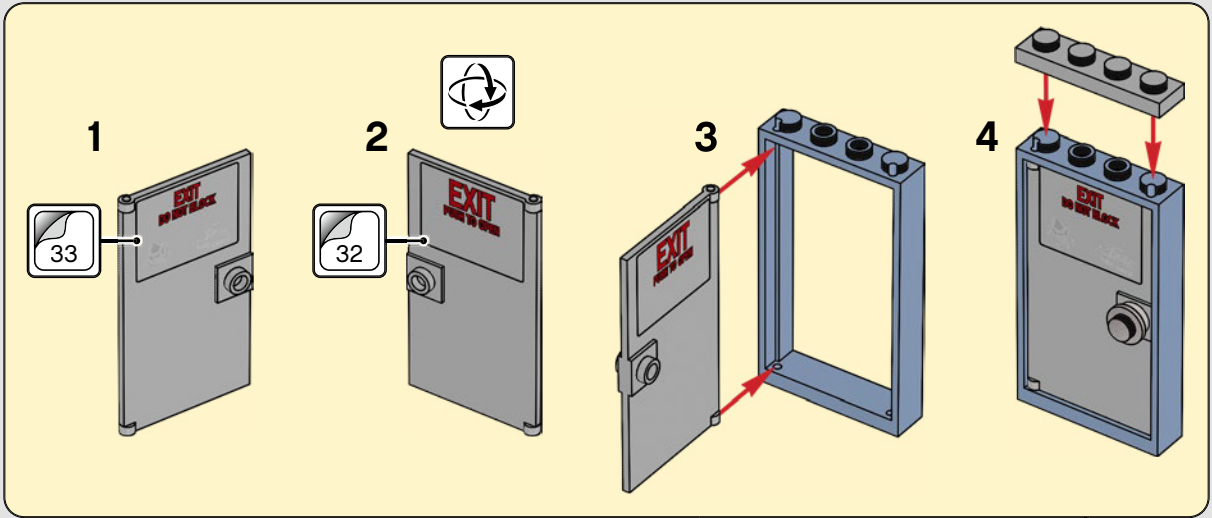

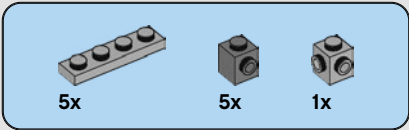

24

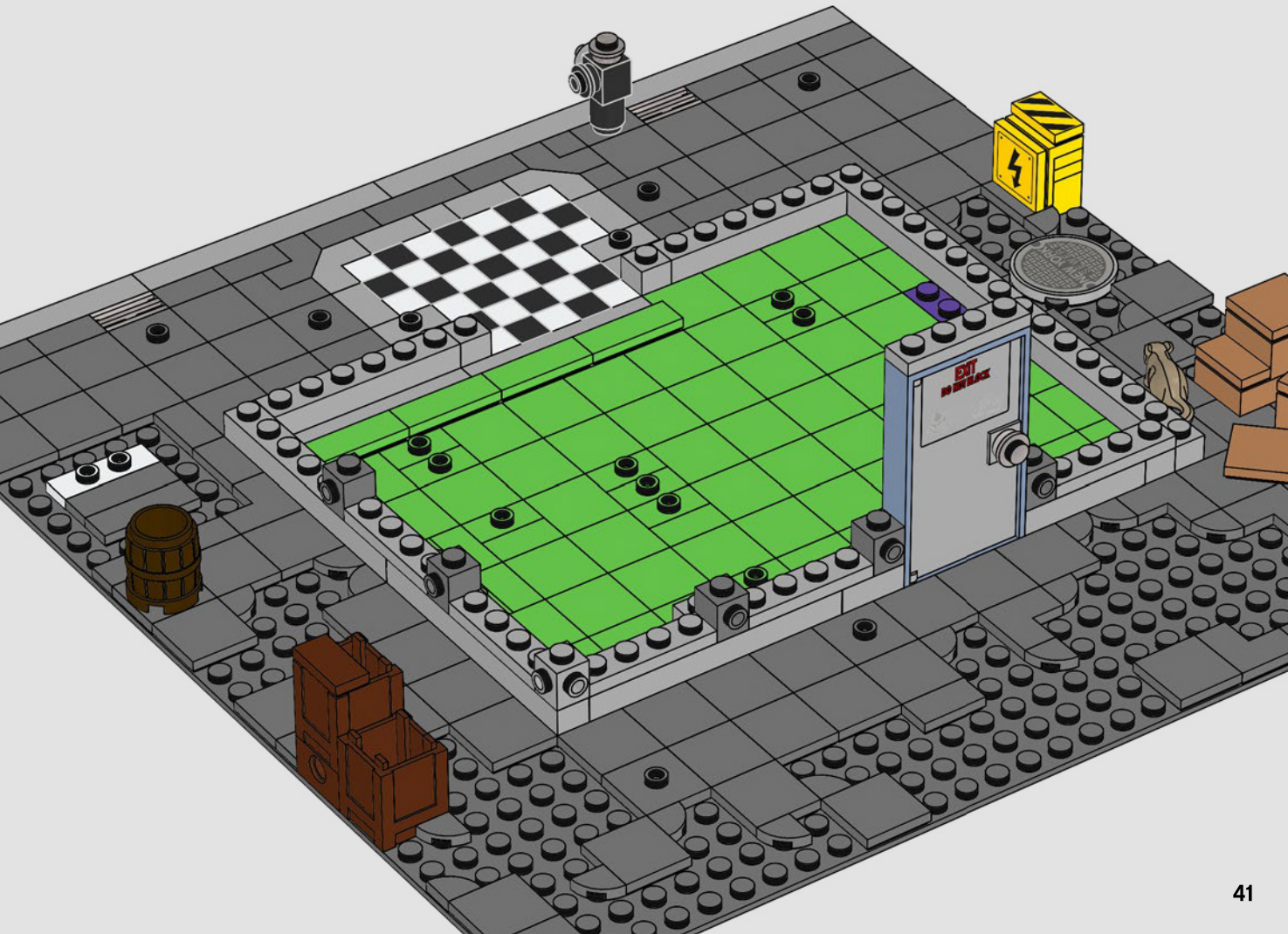





10x

25

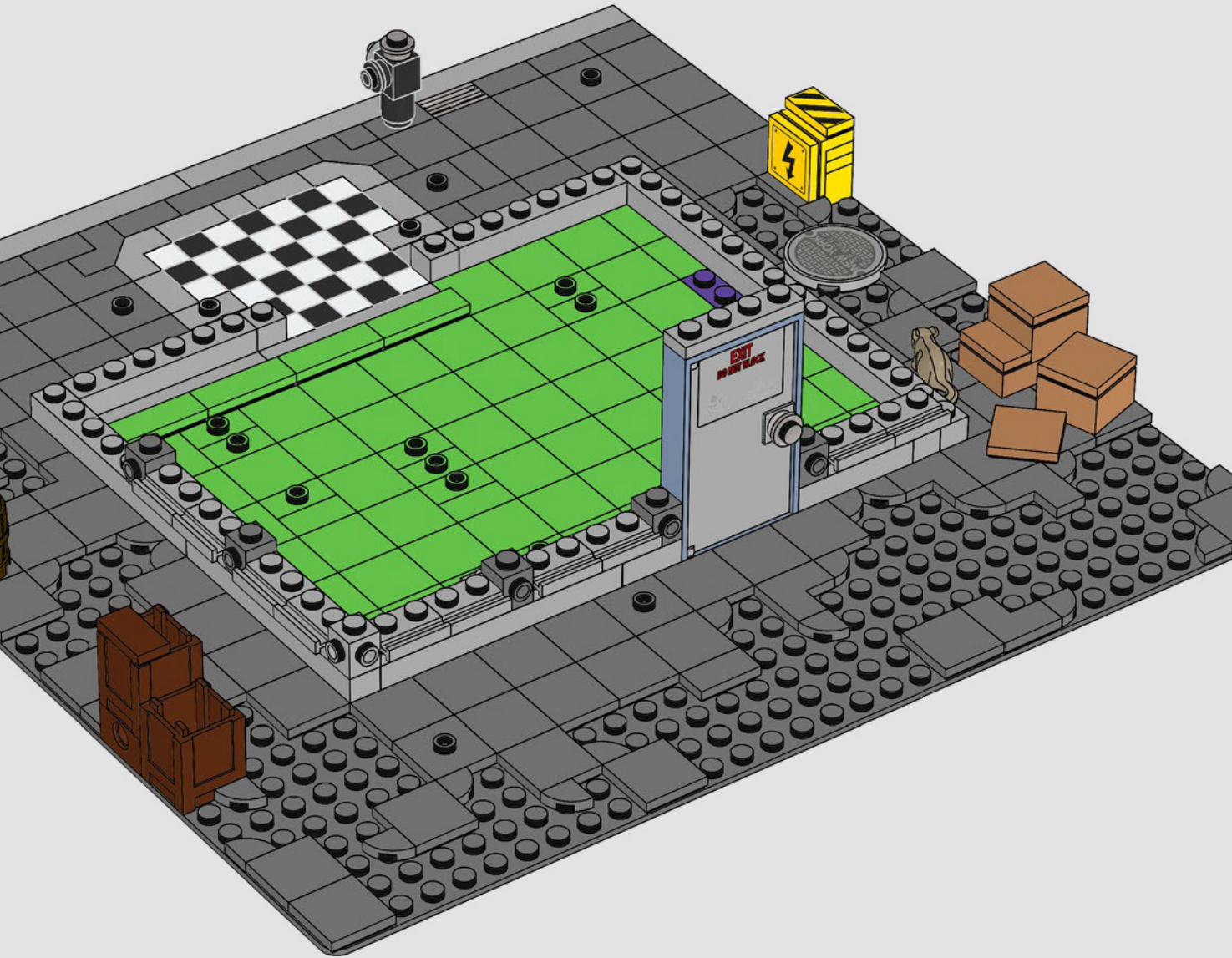

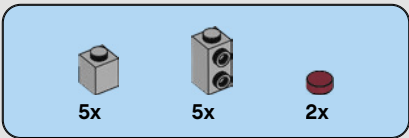

26

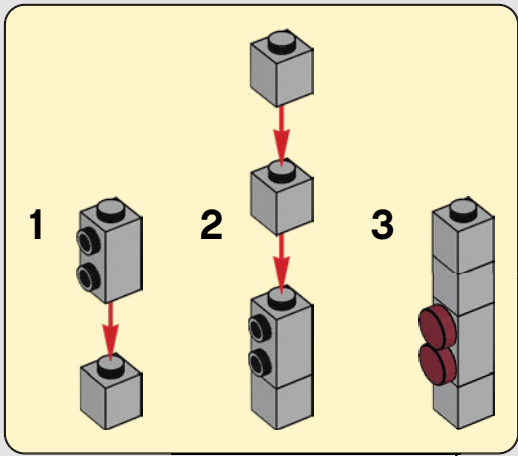

2

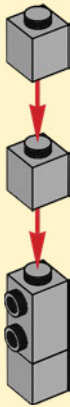

2x

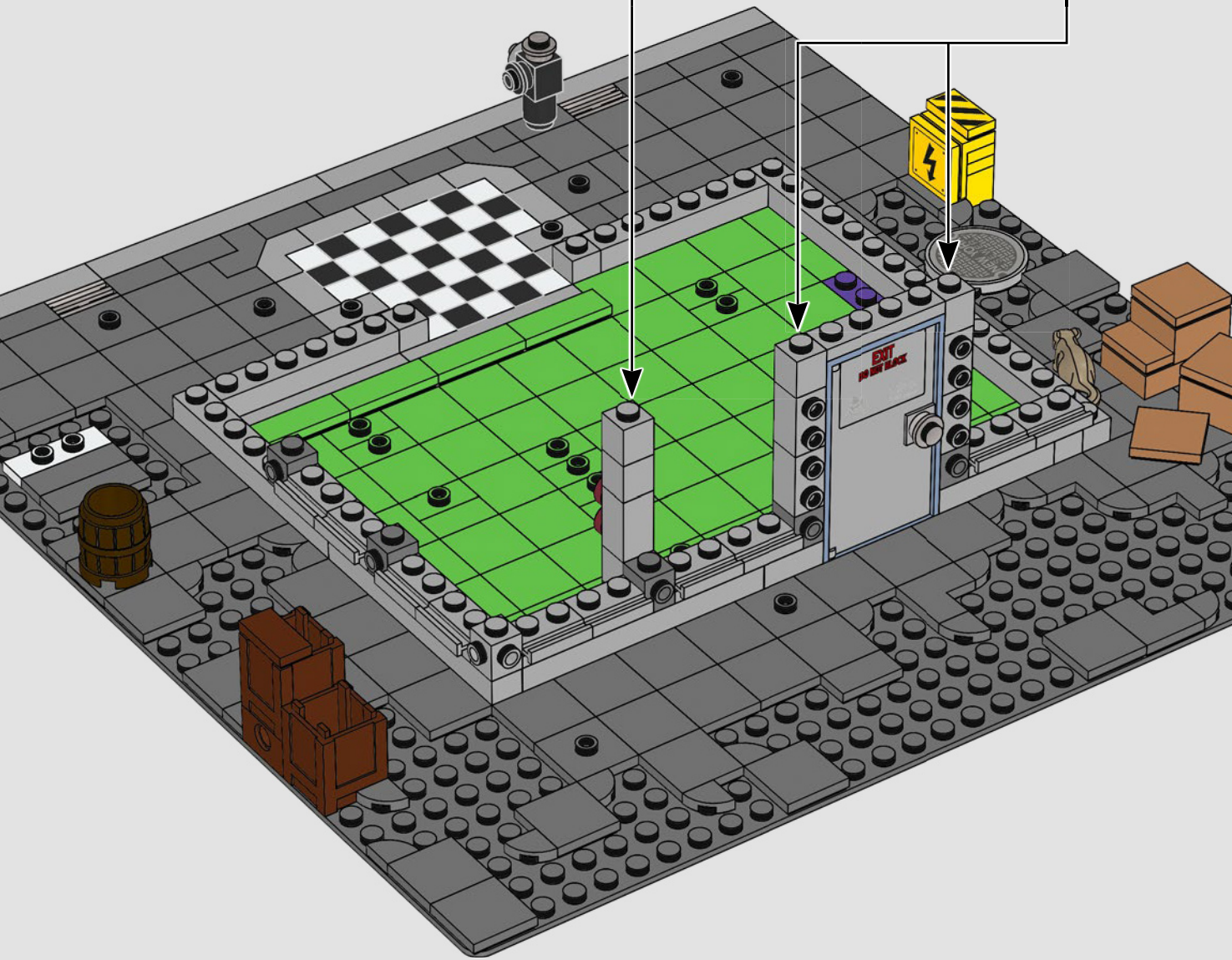
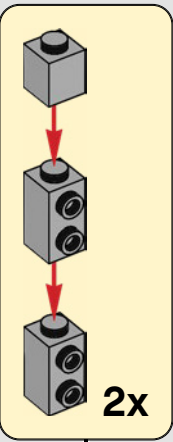





27

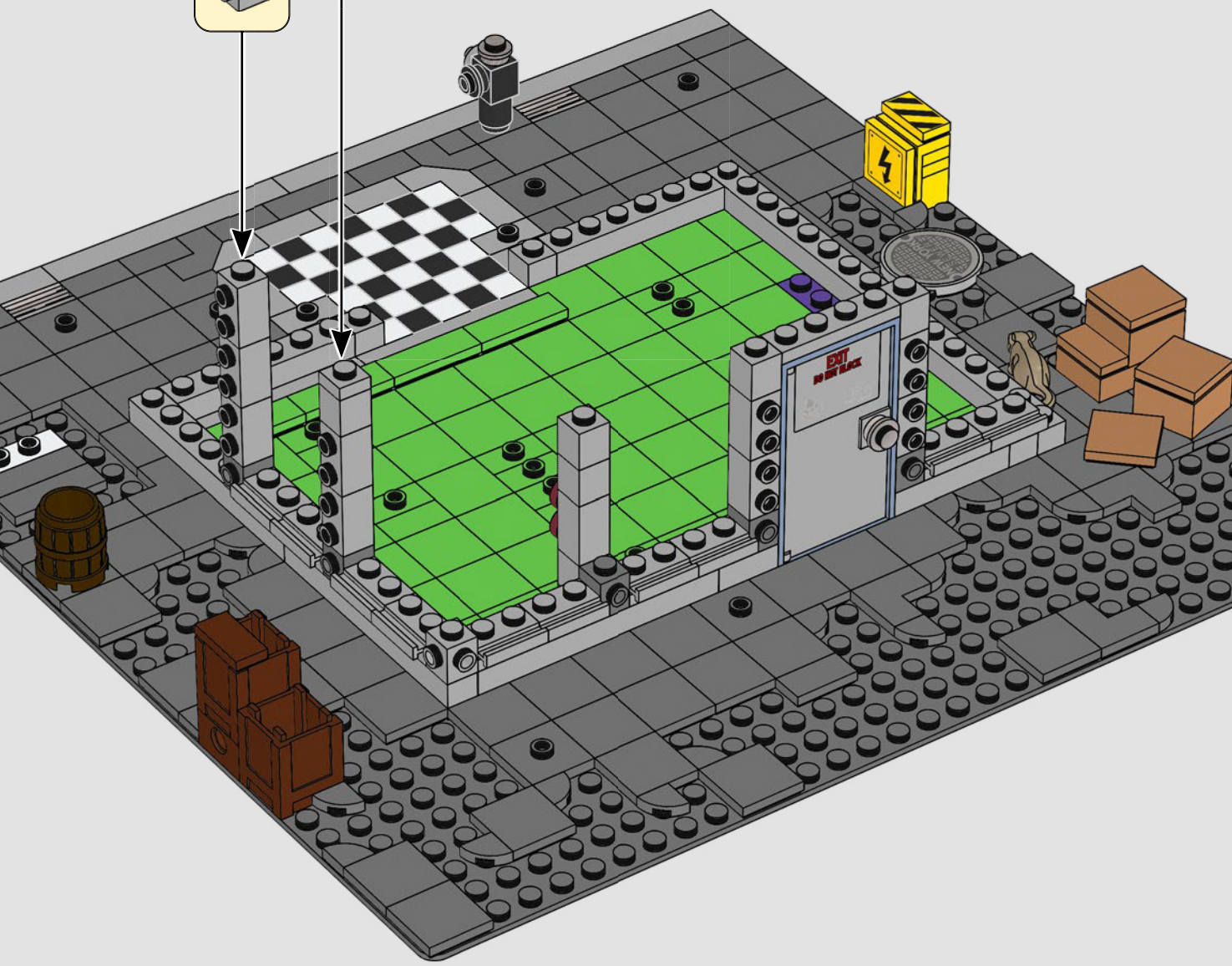
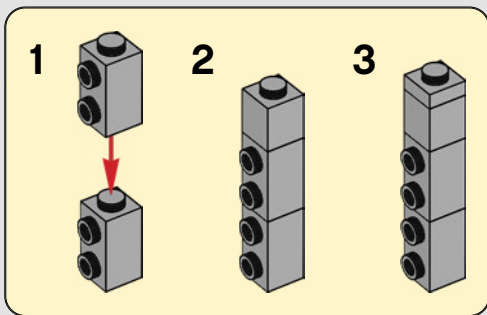
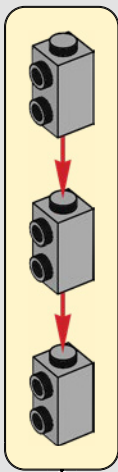

1x 5x

28

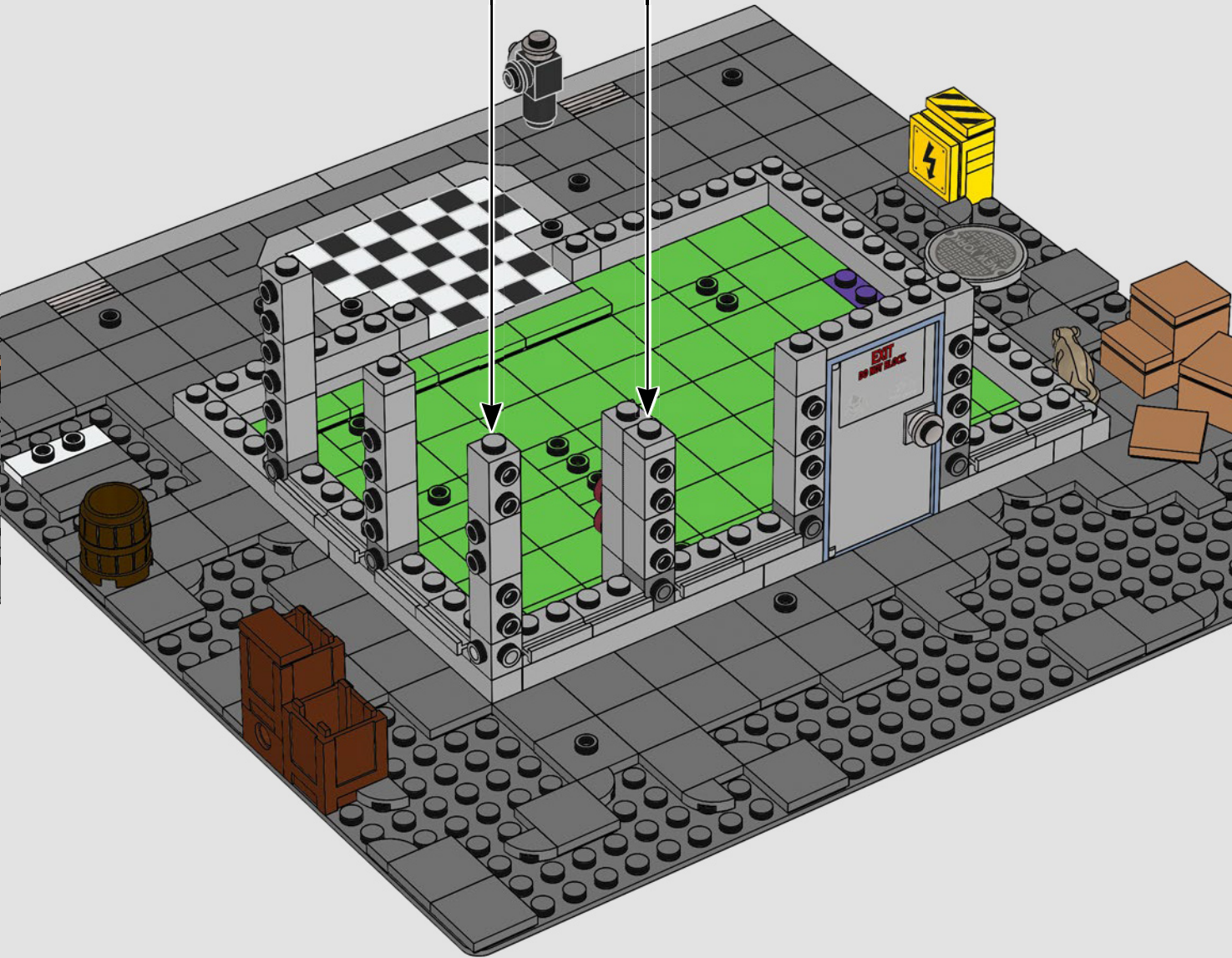
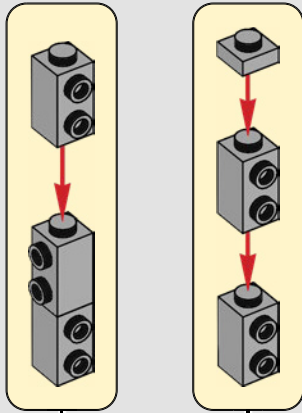



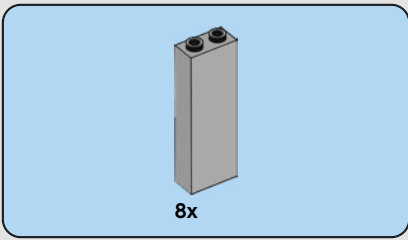

29

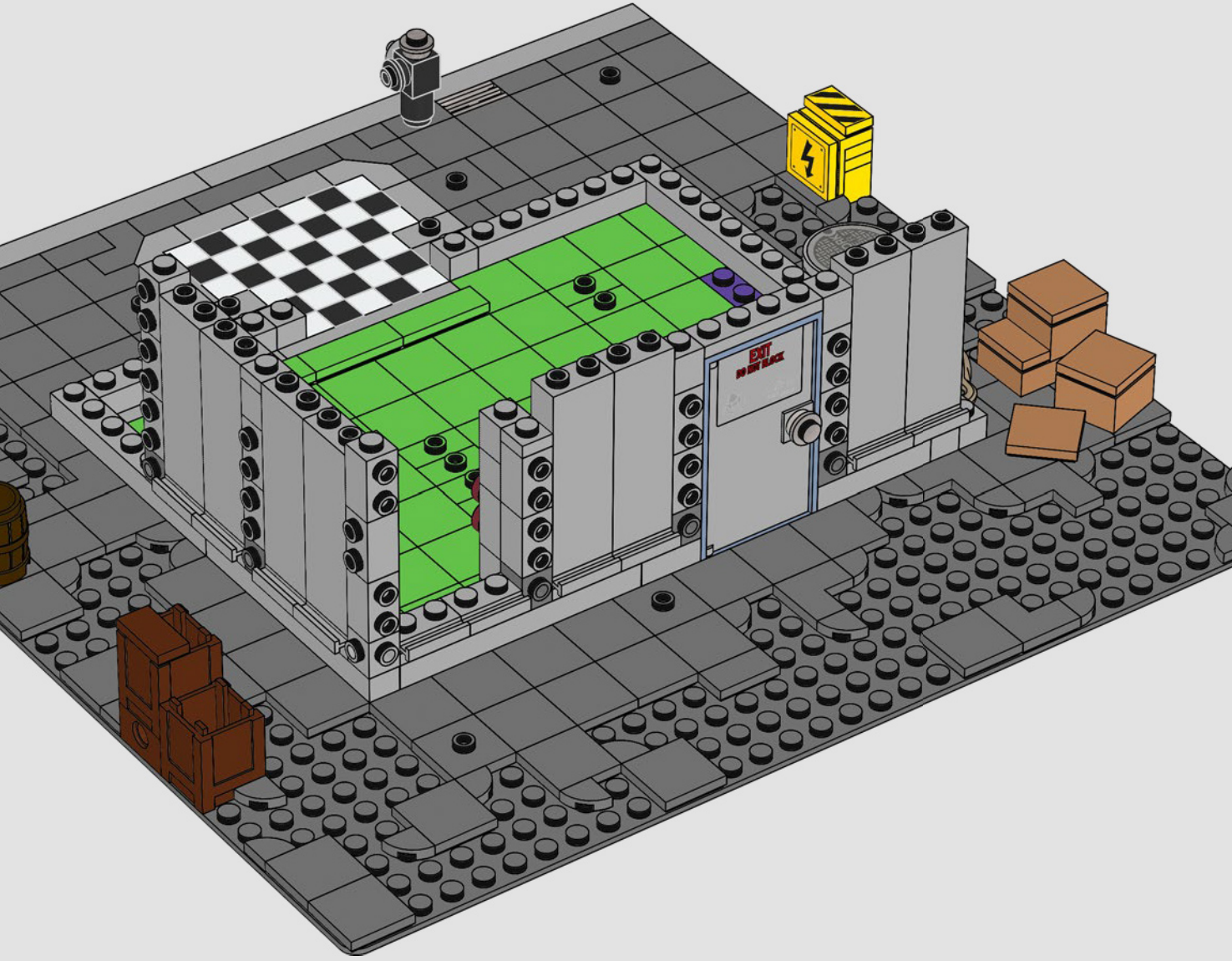

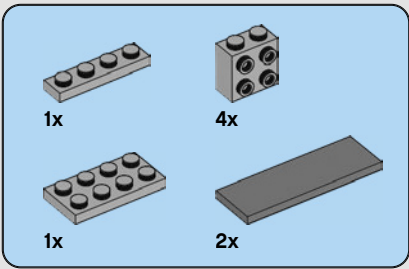

30

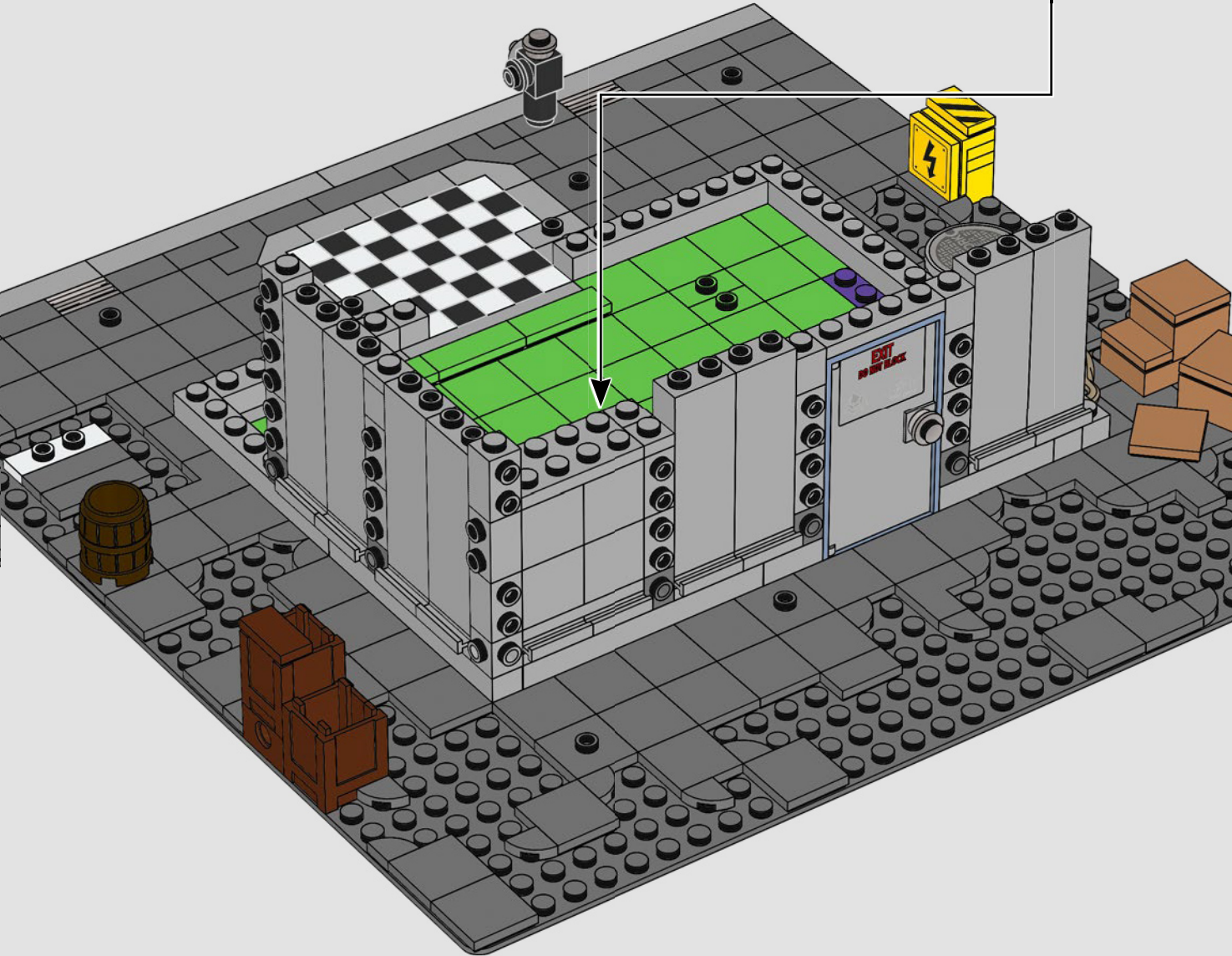
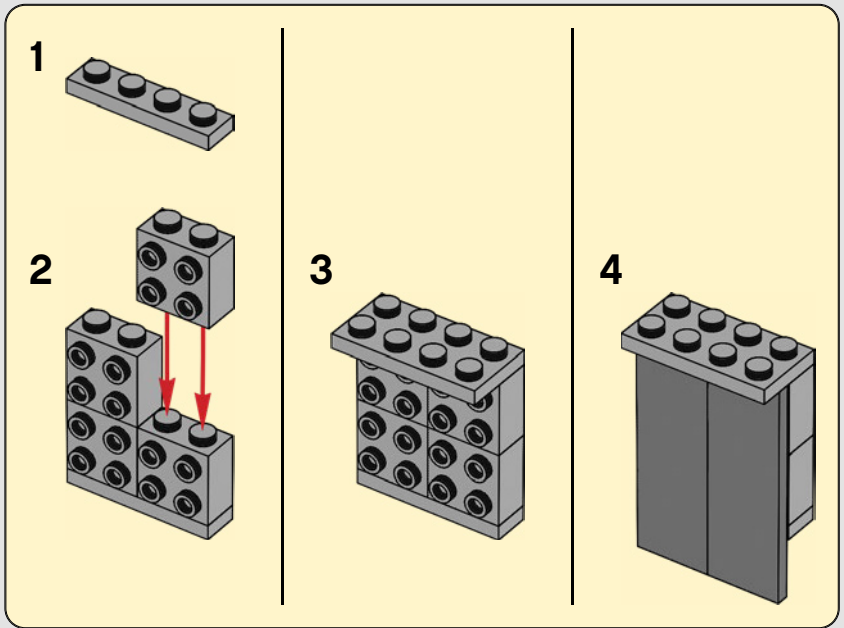



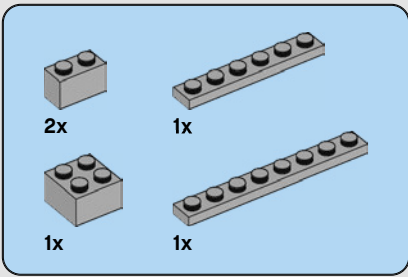

31

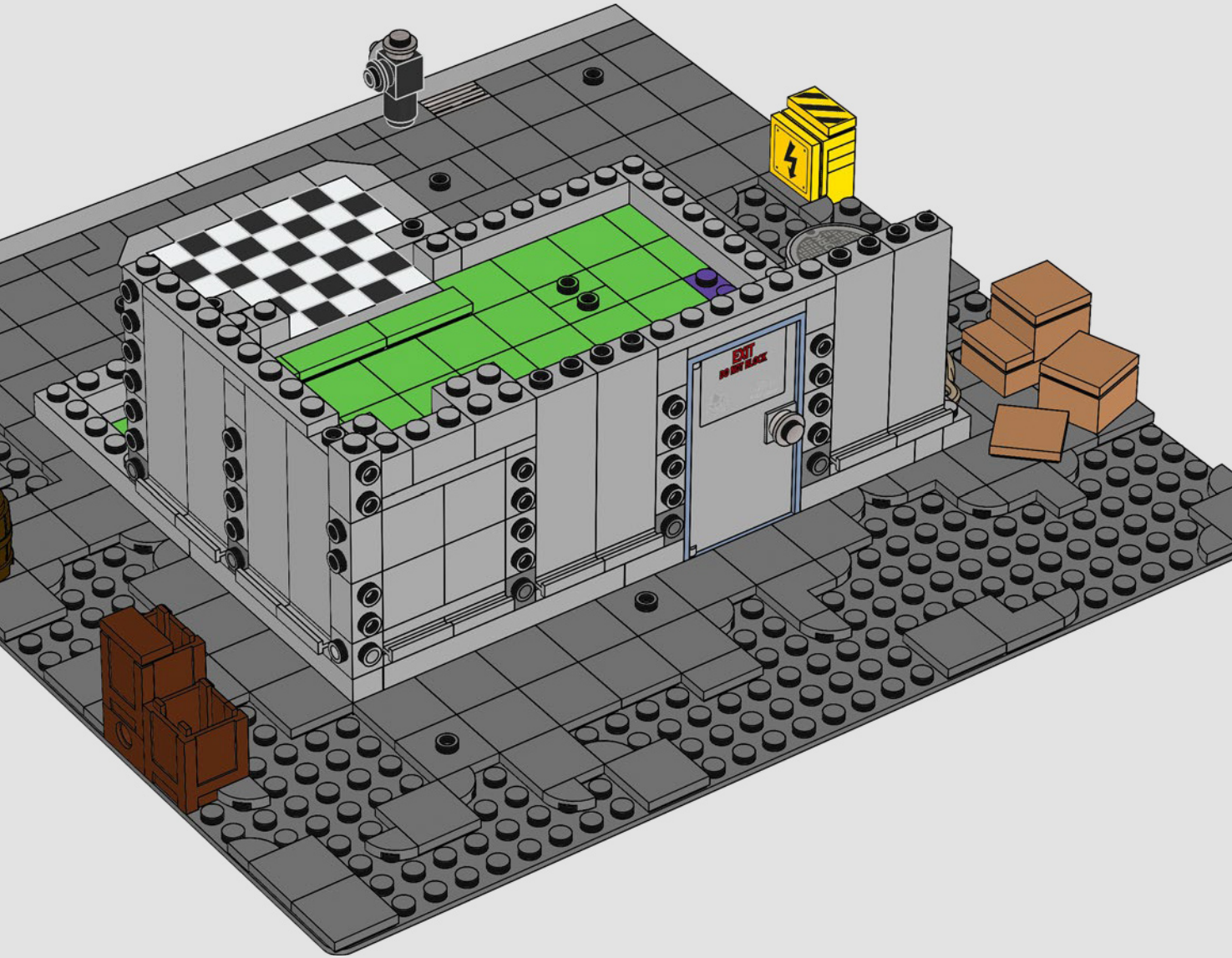

1x	3x	2x	3x

# 32

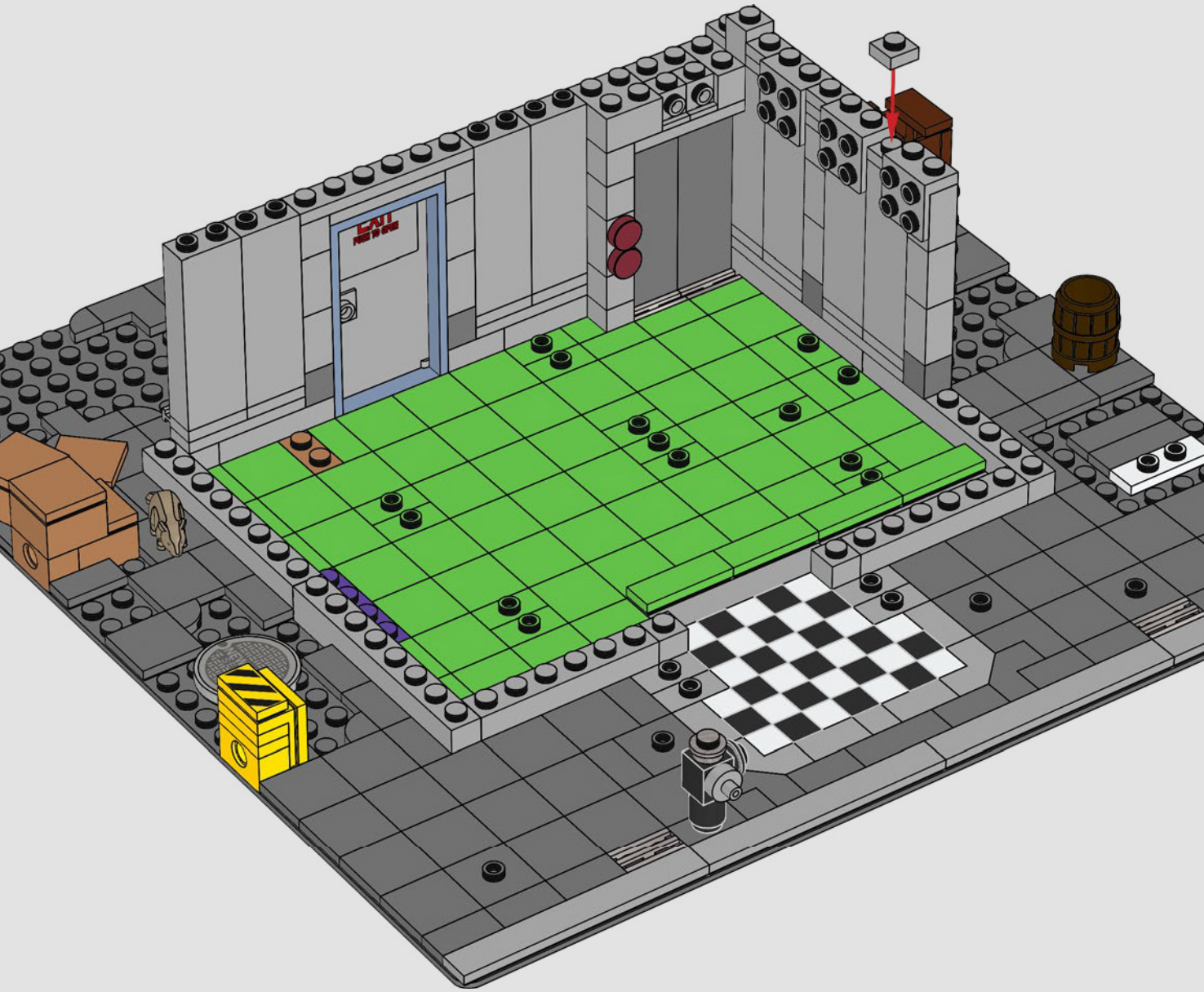



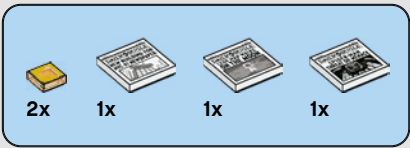

# 33

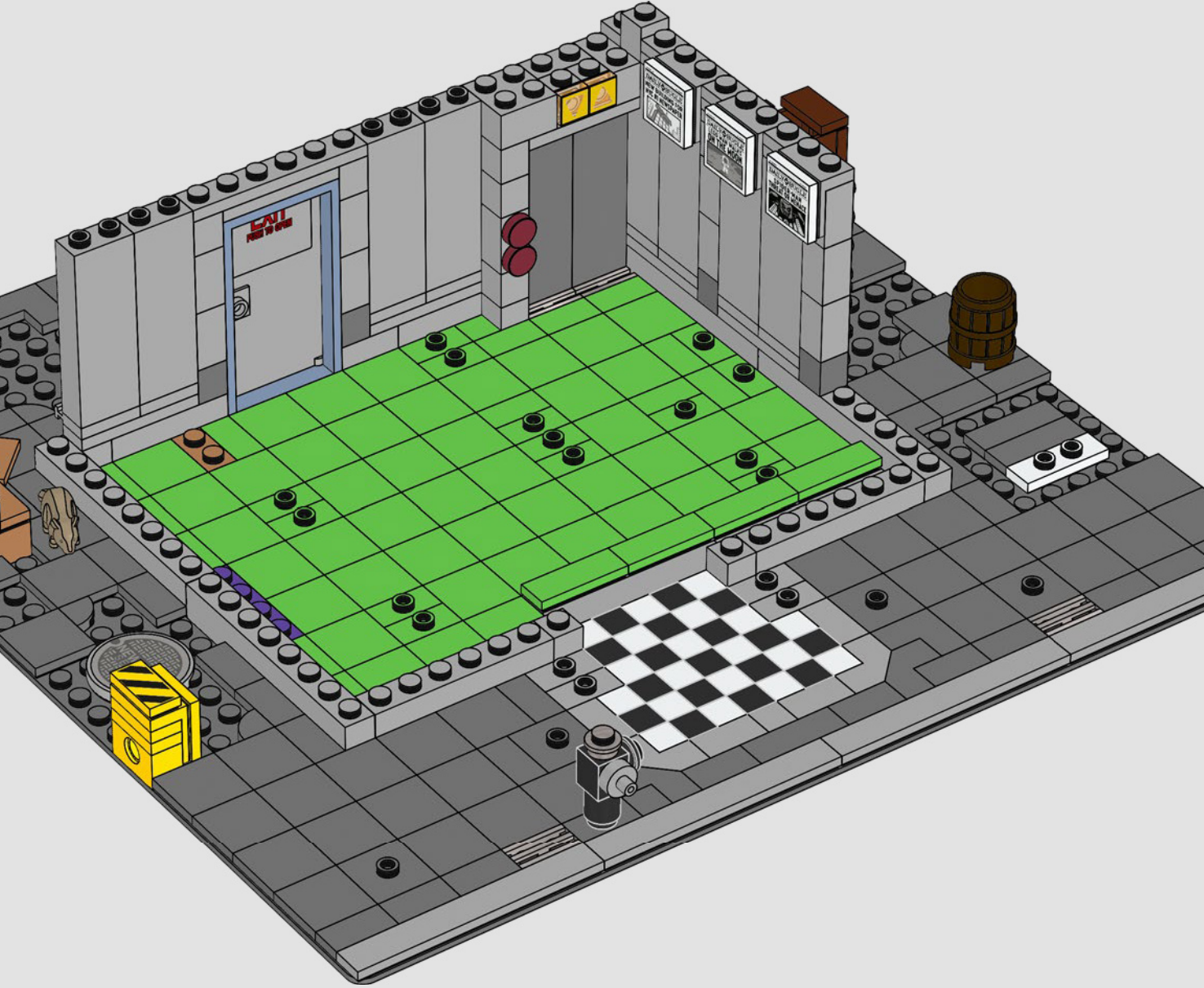

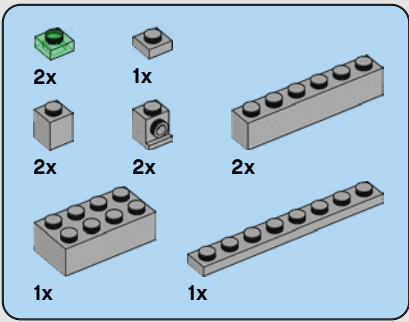

34

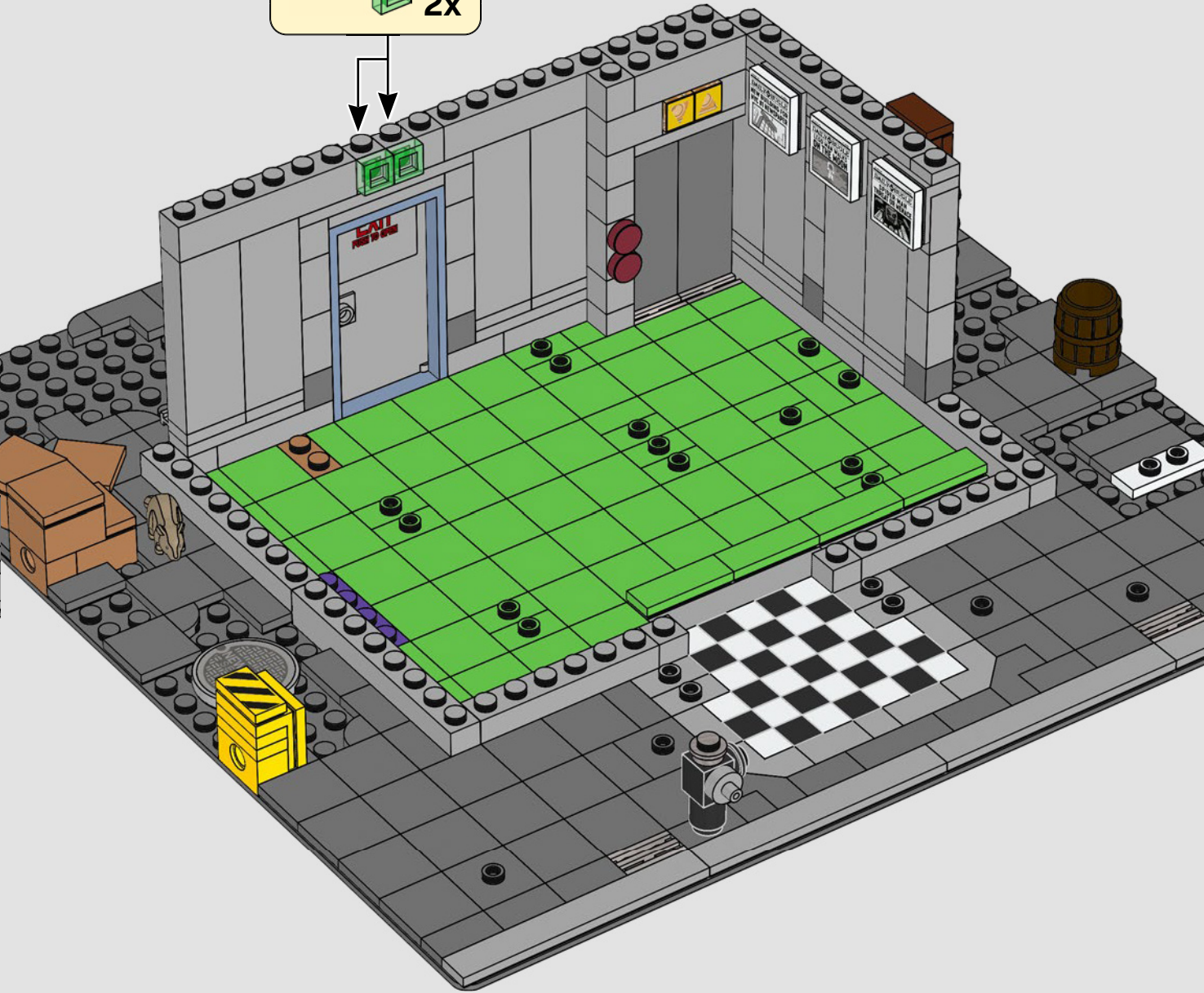
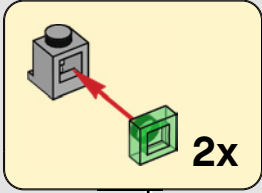



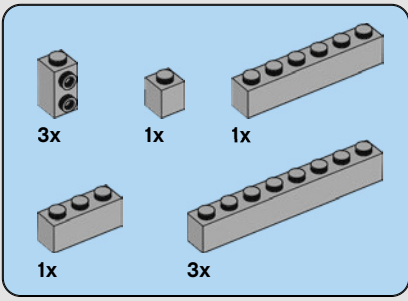

35

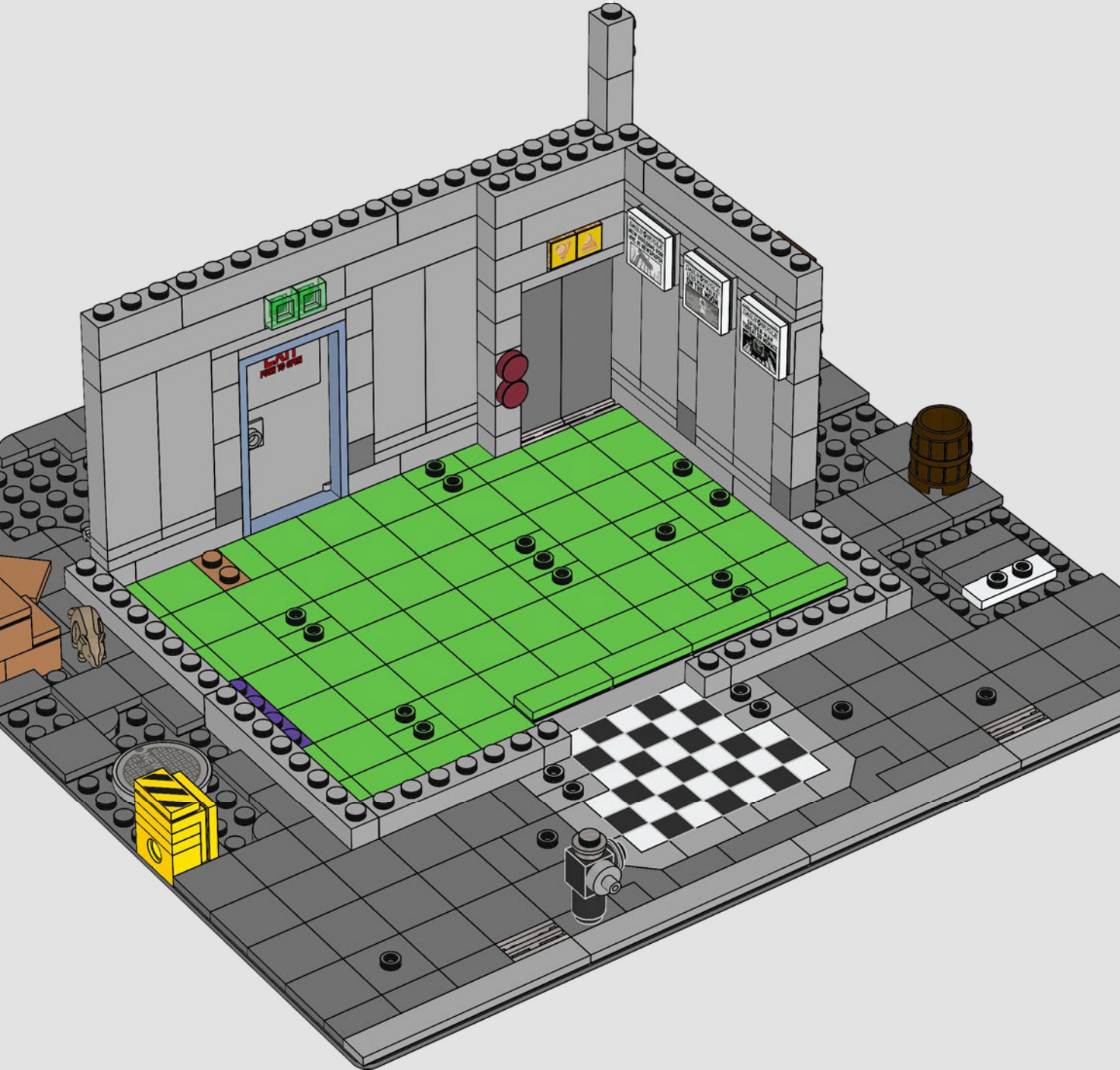
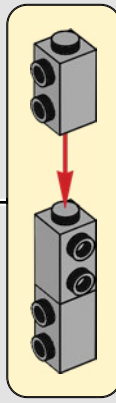

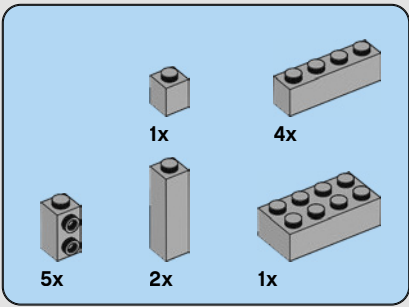

# 36

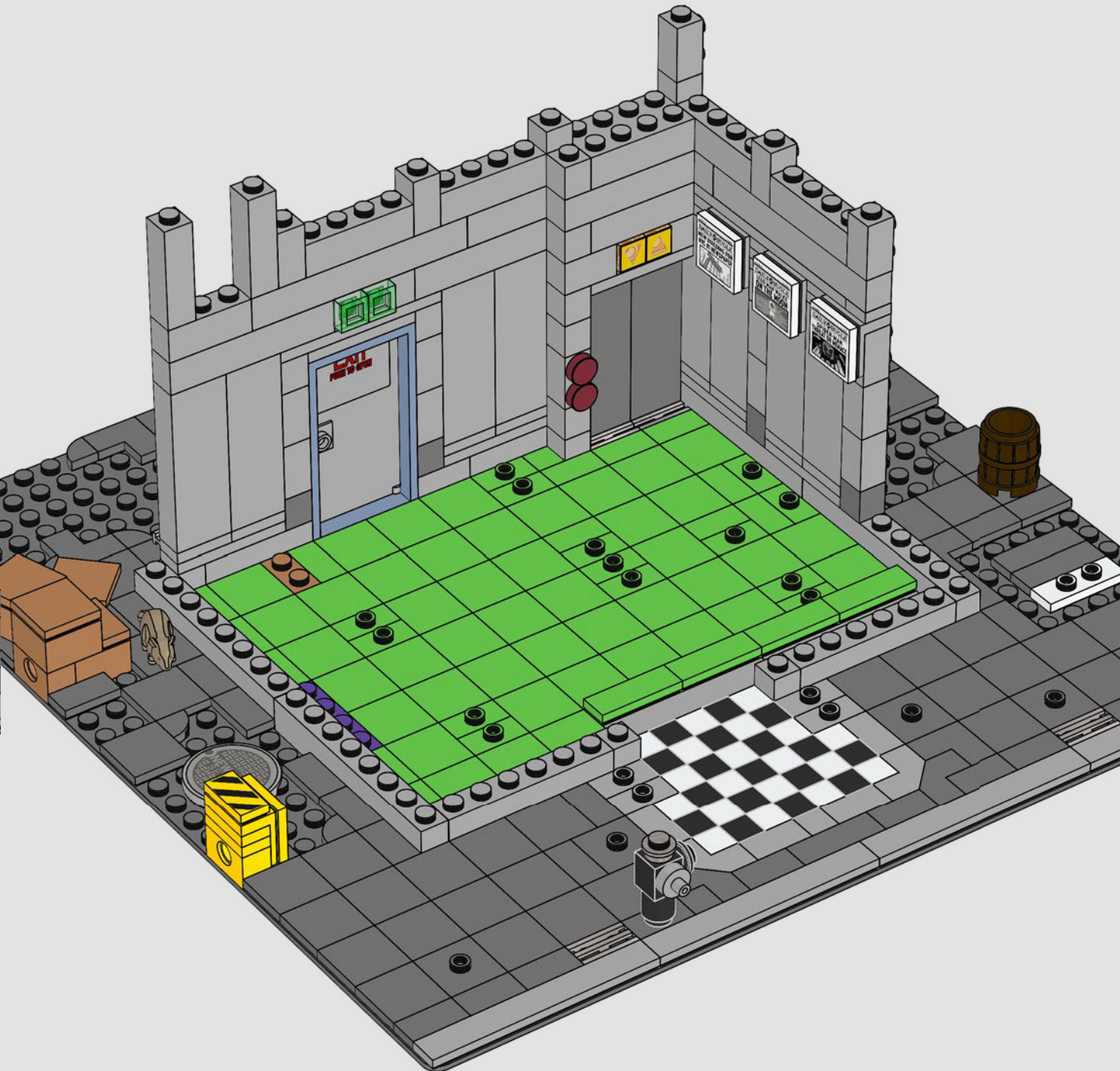



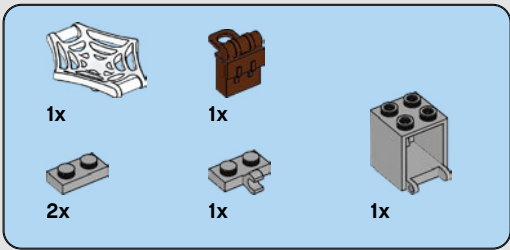

# 37

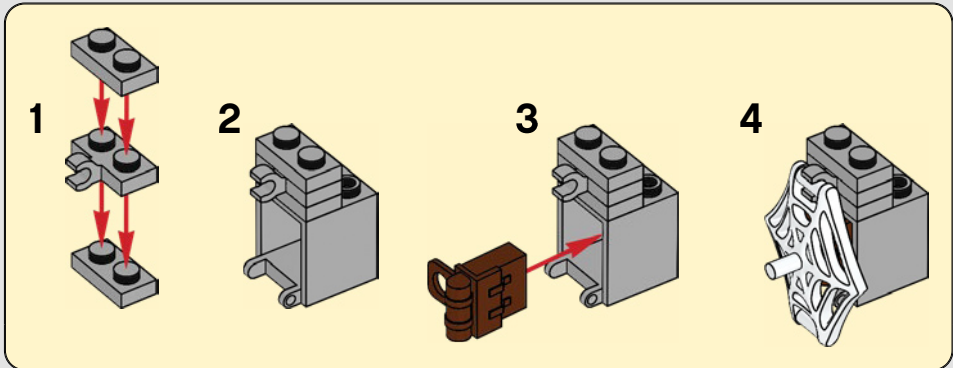

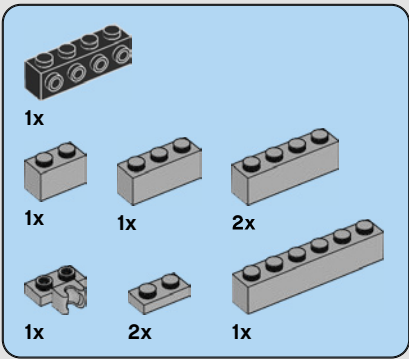

38

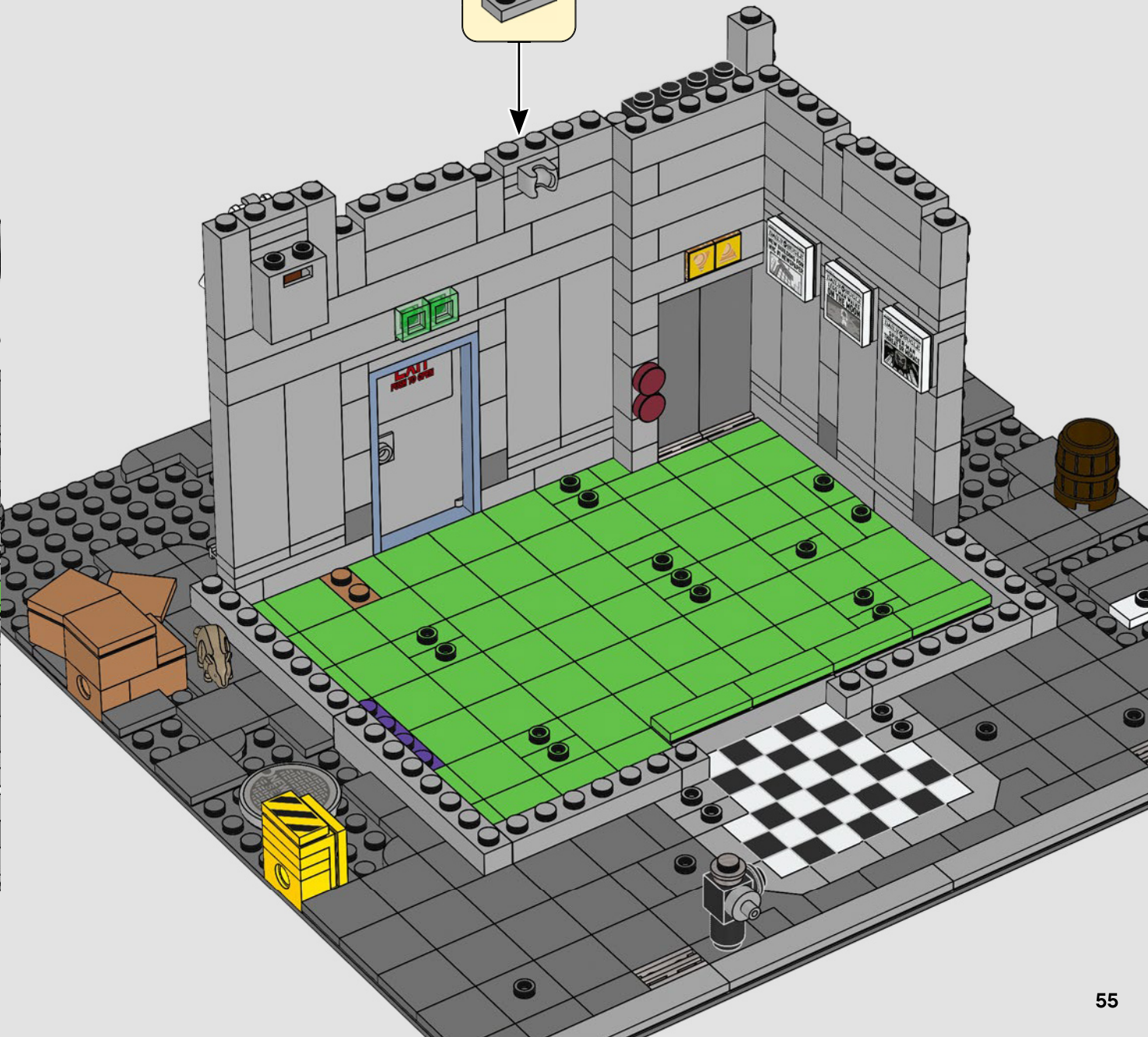
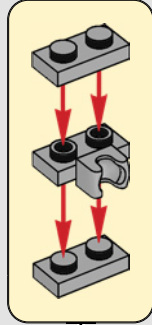



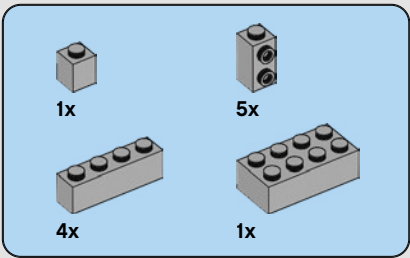

39

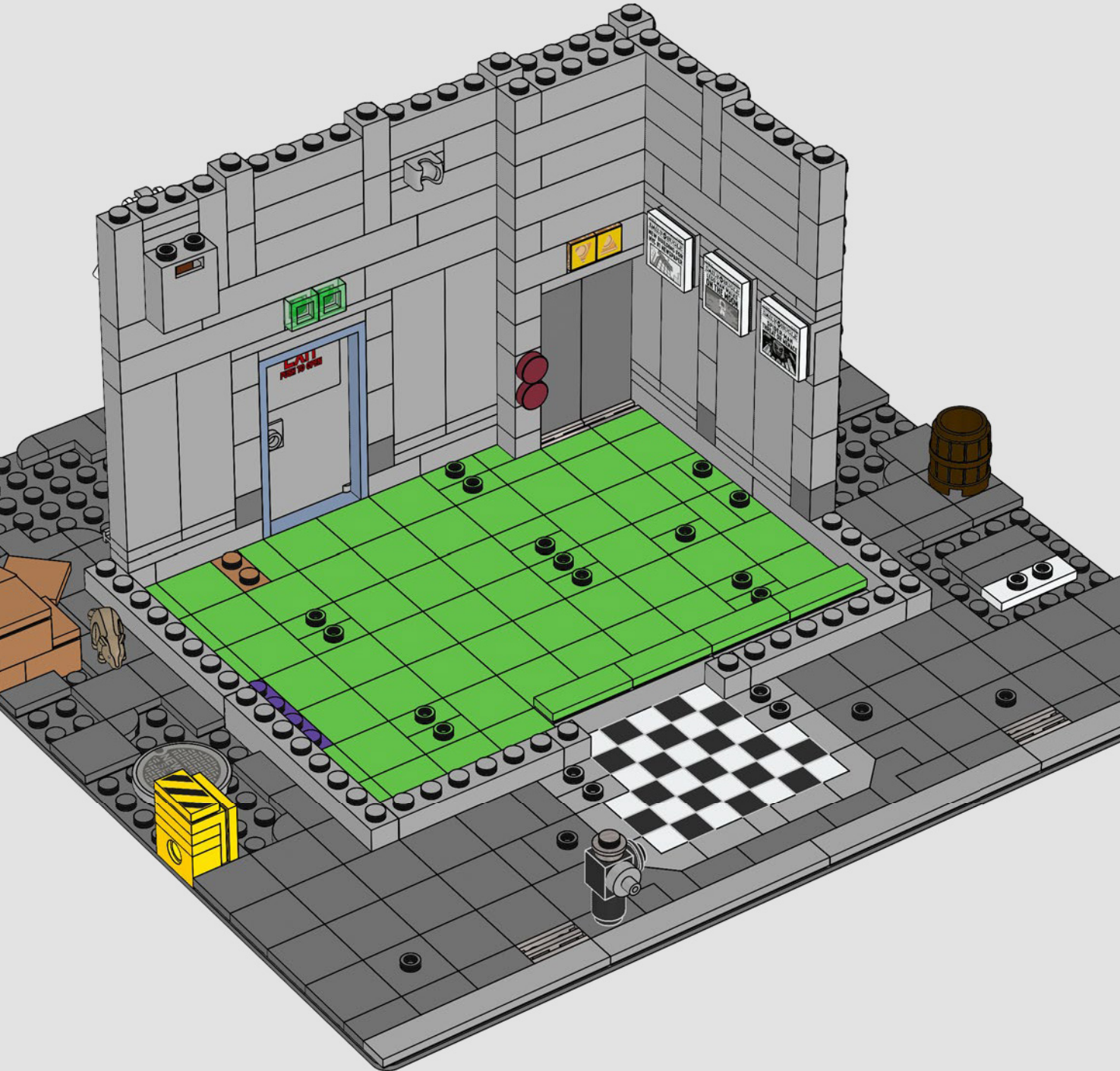



1x



12x

40

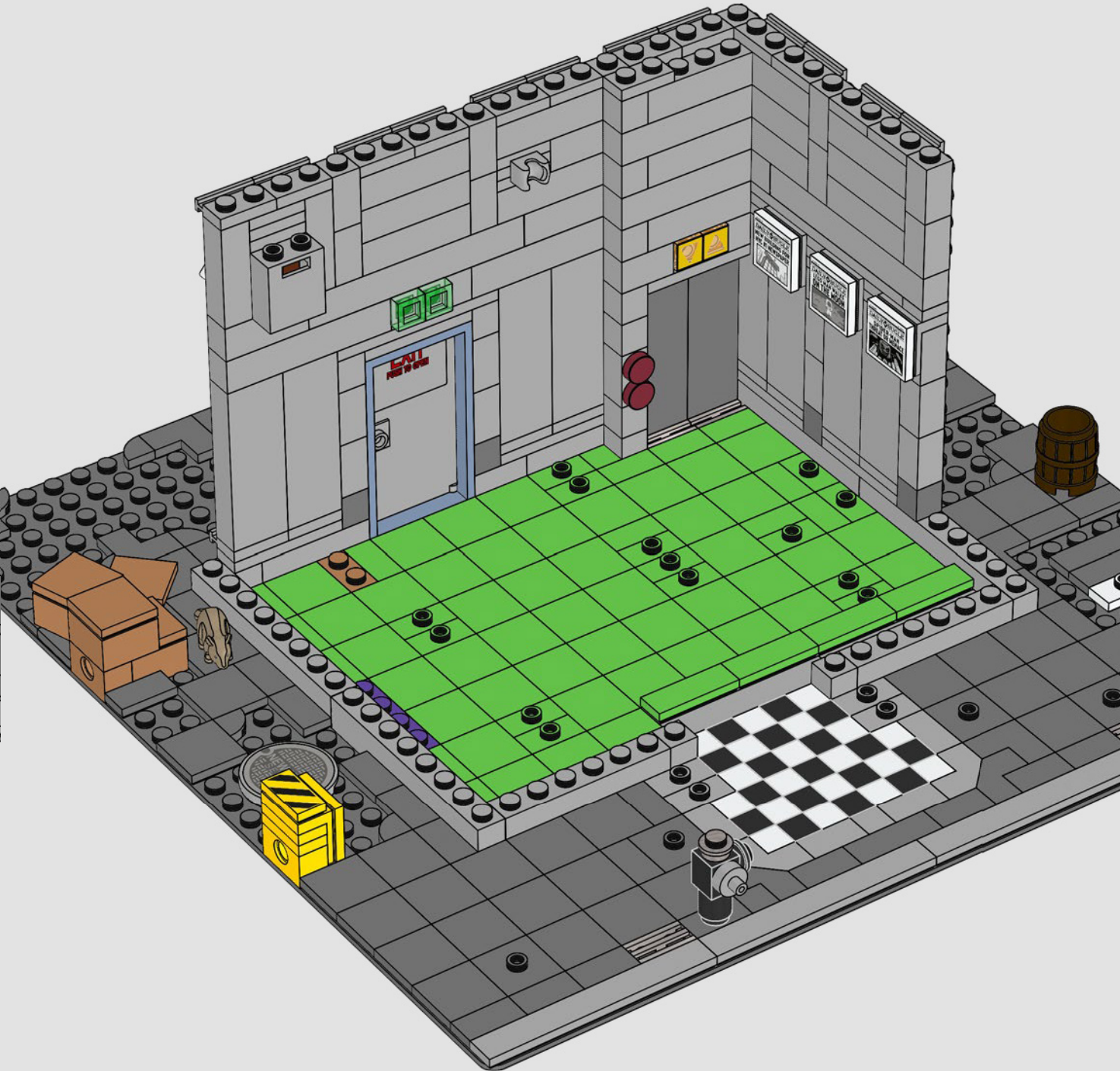



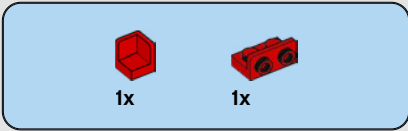
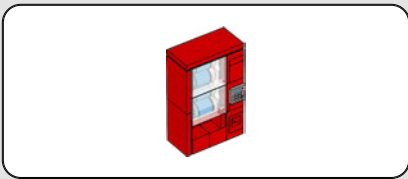

41

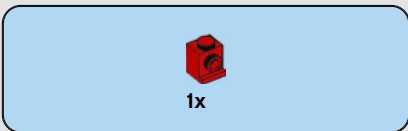
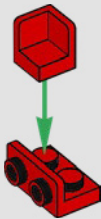

42



43

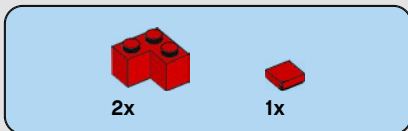
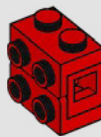

44

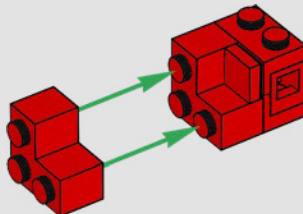

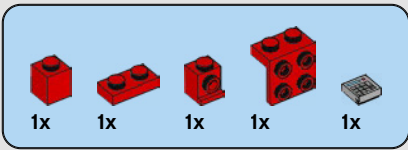

45

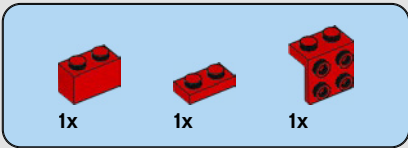
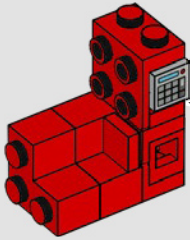
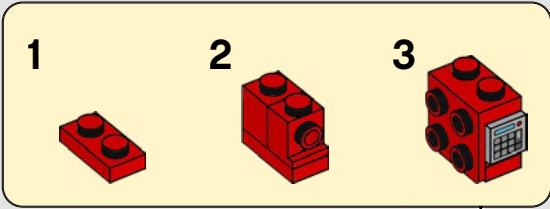

46

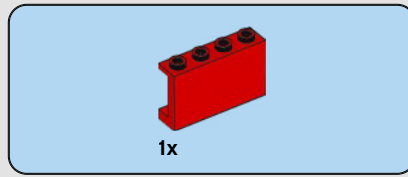
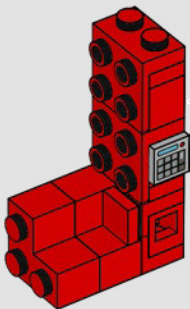
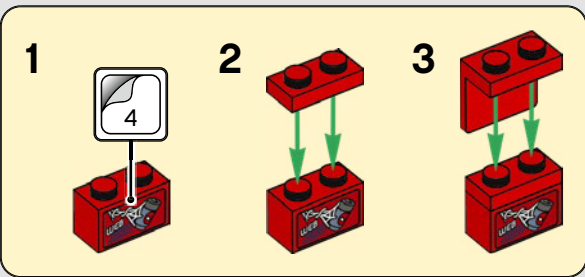

47

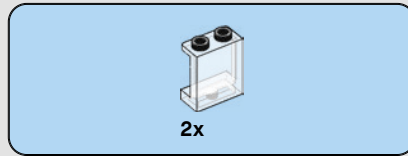
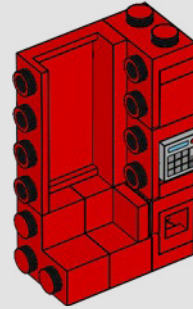

48

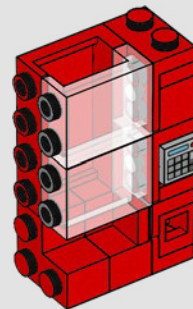



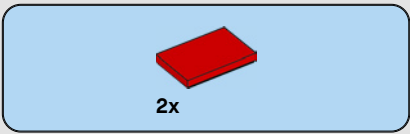

49

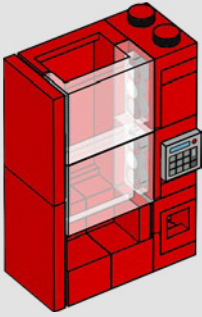

50

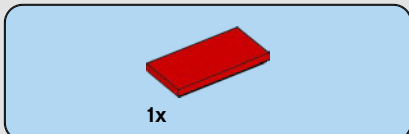
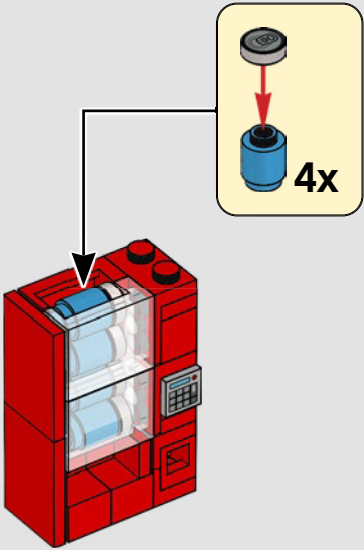

51

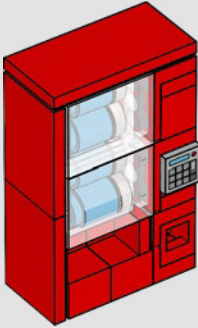

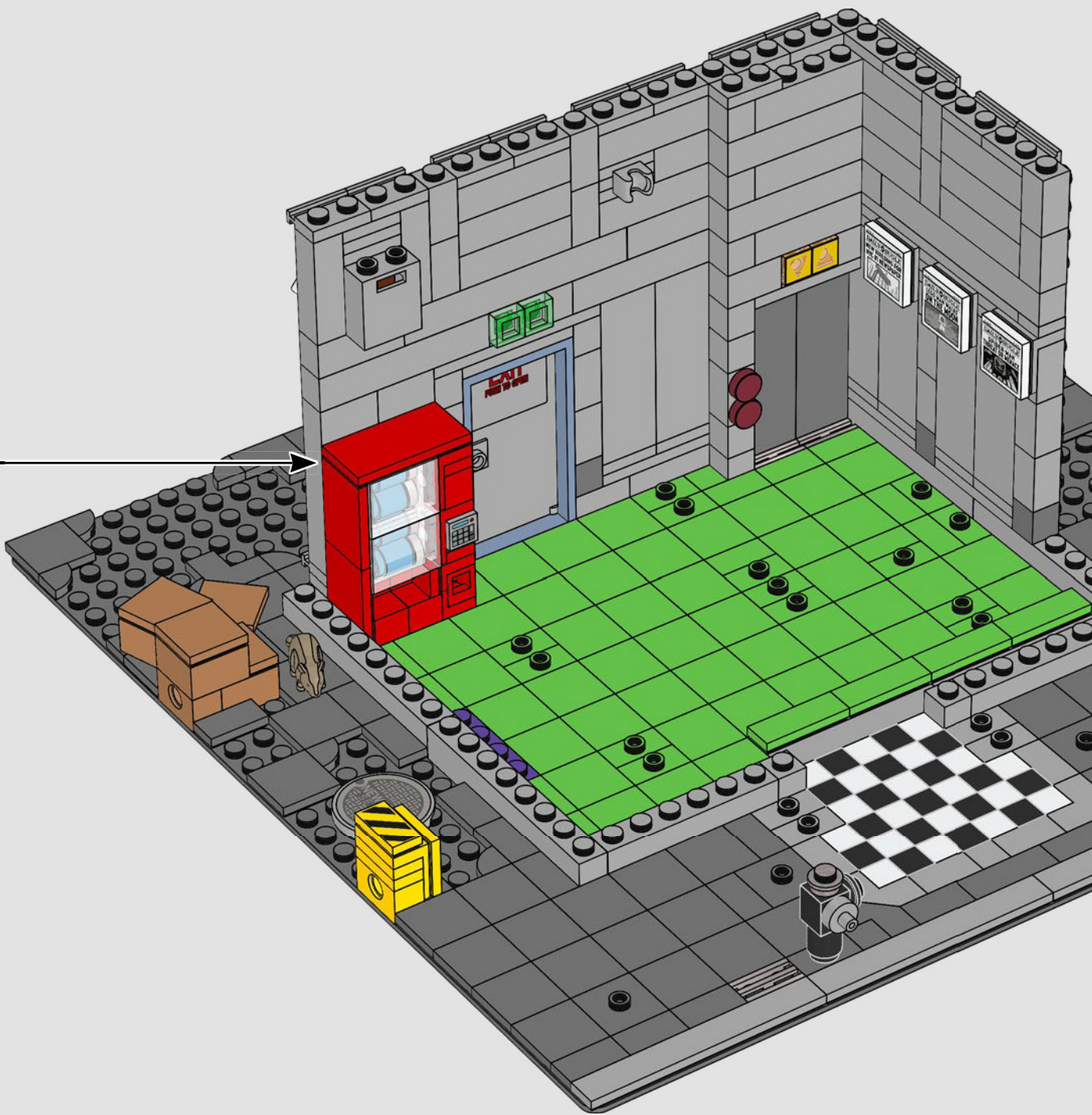



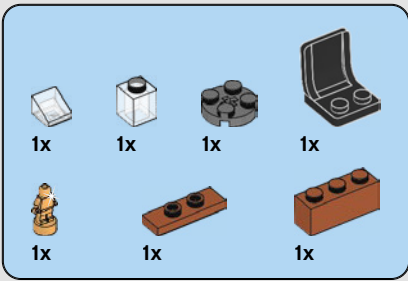

53

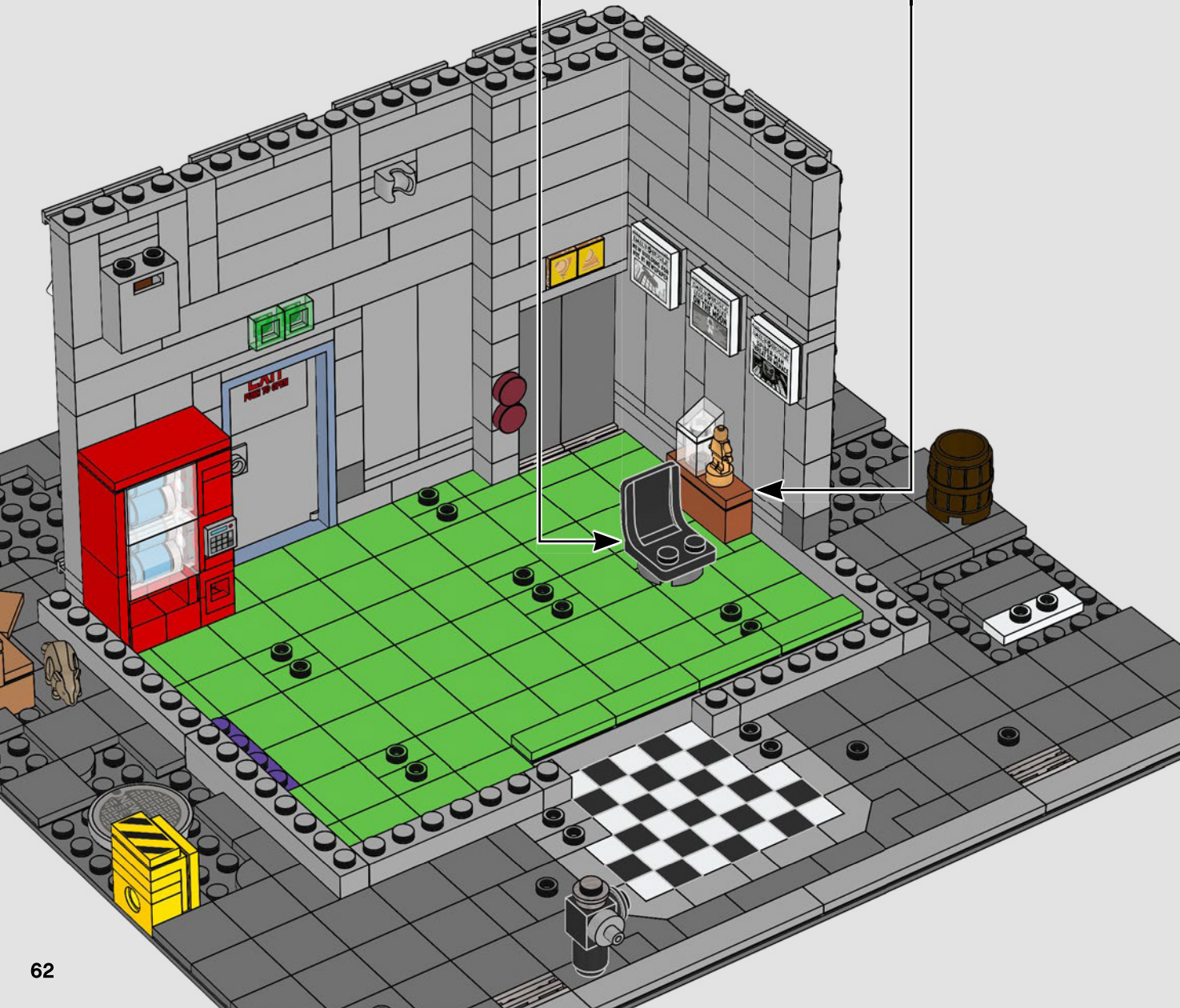
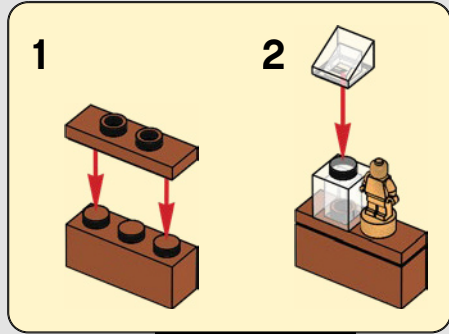
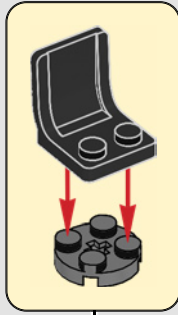

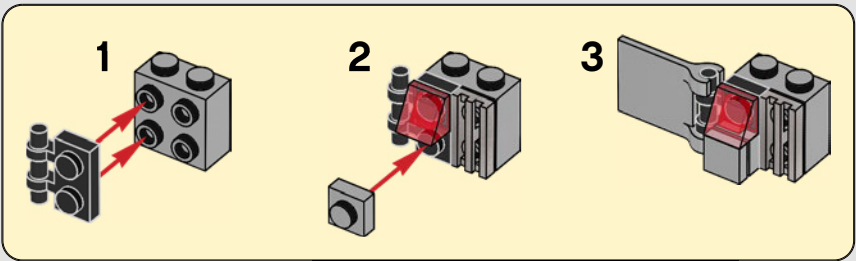
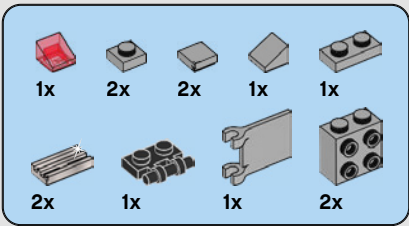

# 54

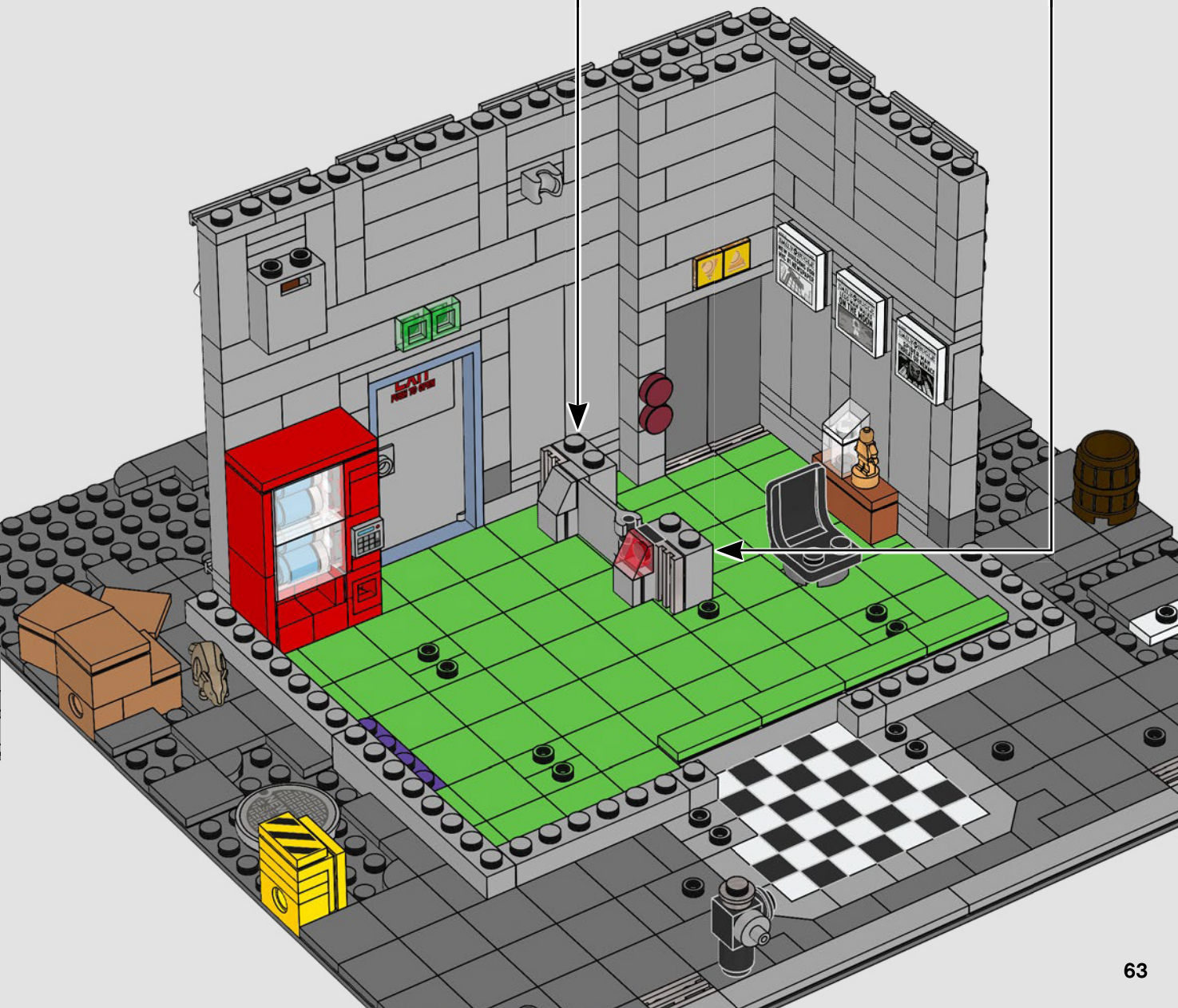
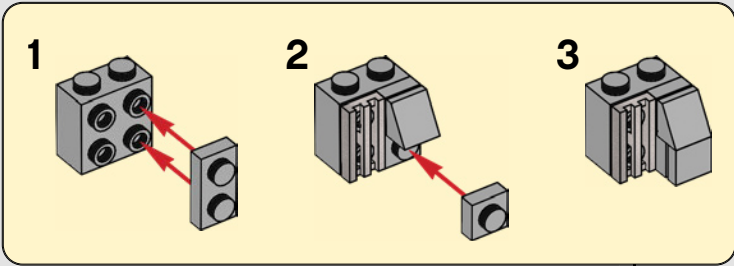



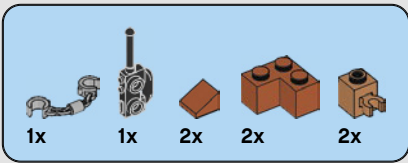

55

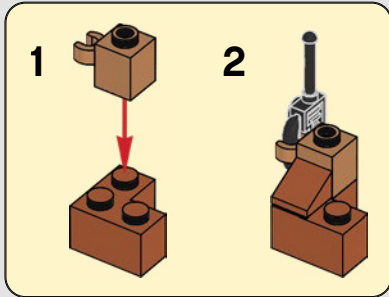

2

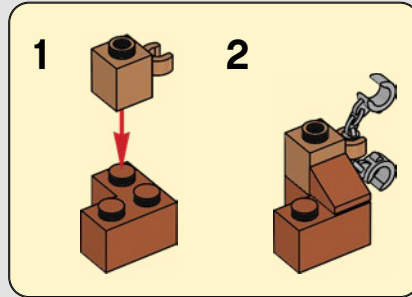

2

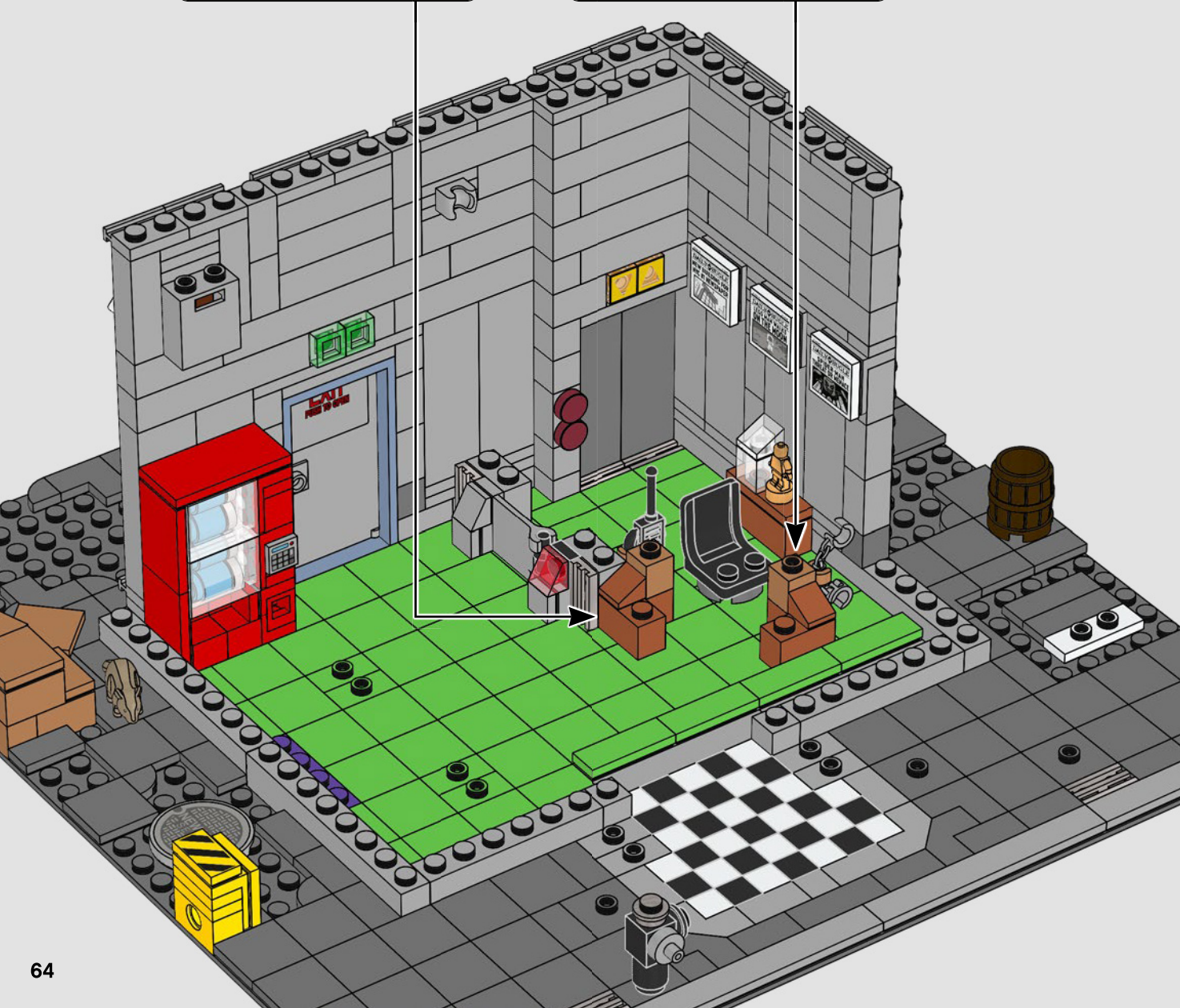

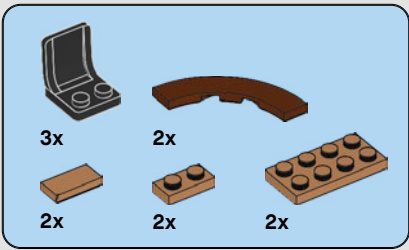

56

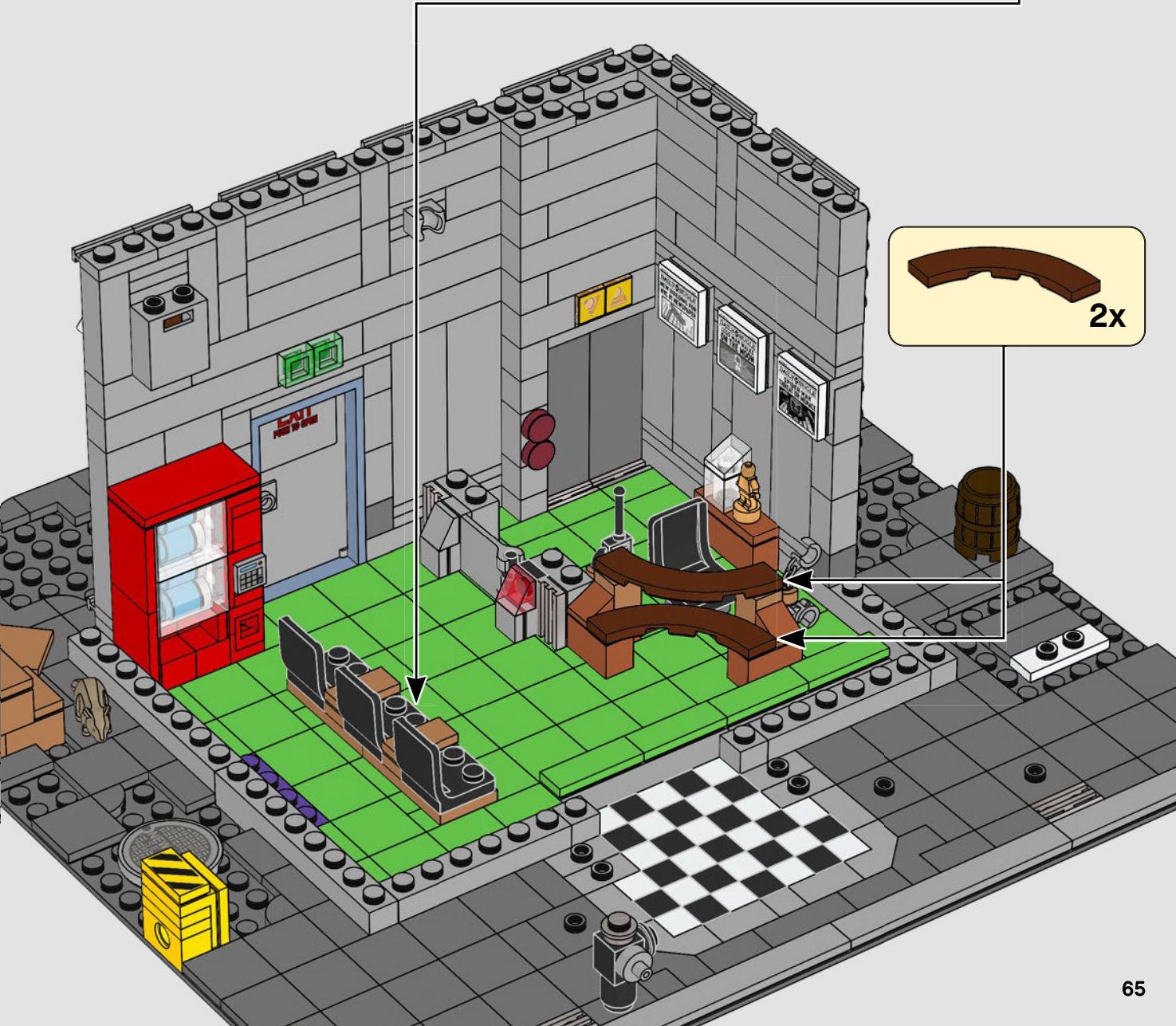
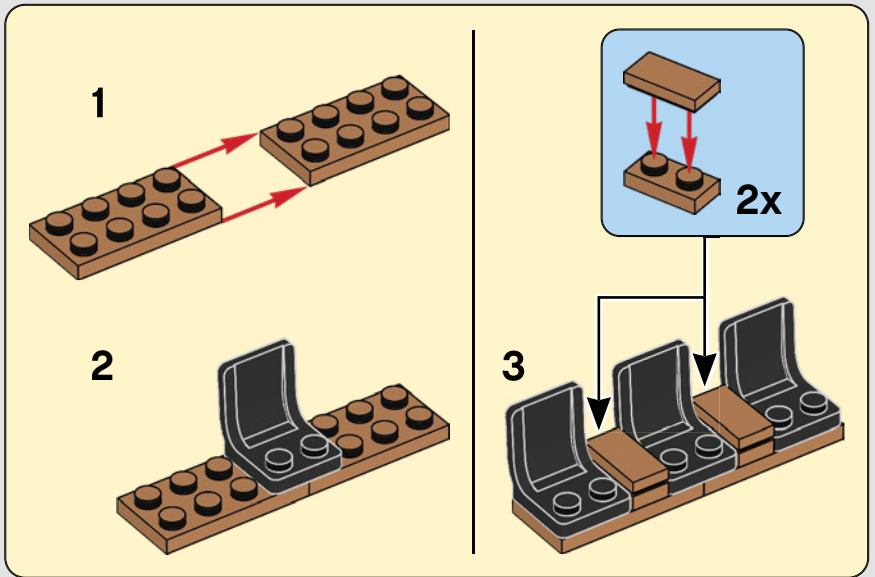





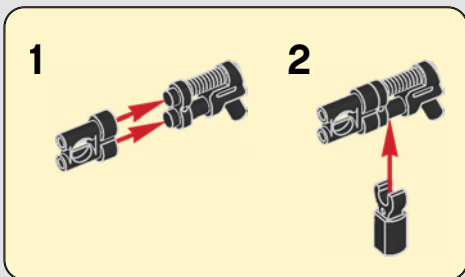
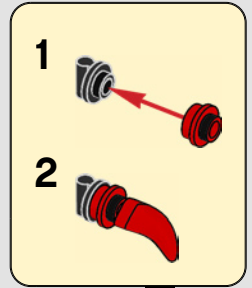
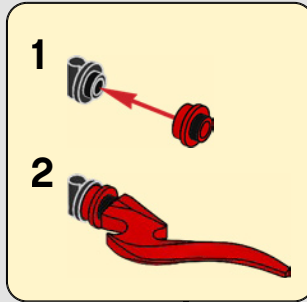
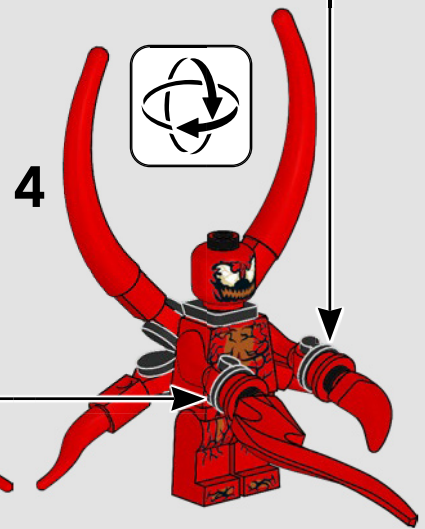
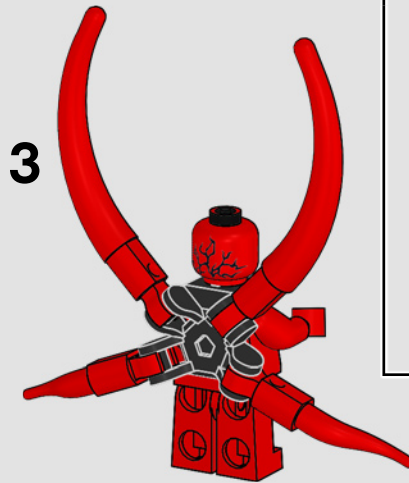
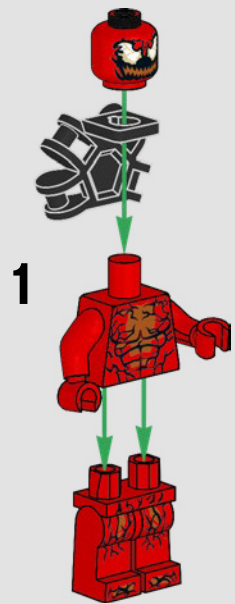
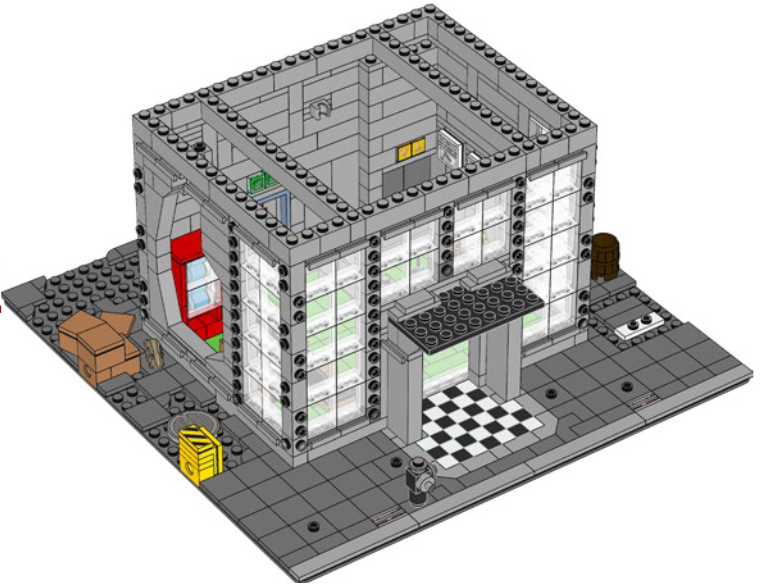
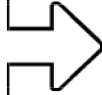





6x



1x

58

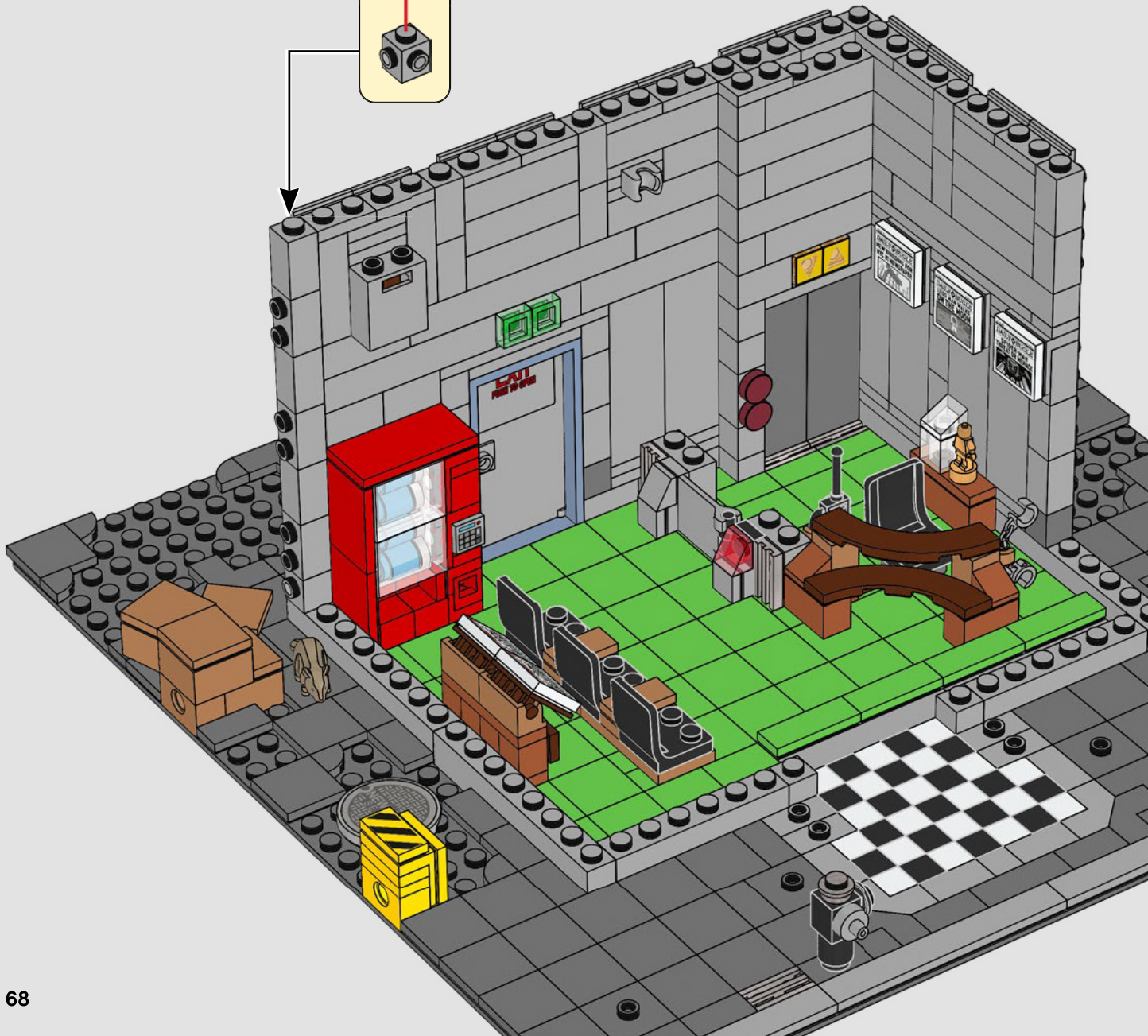
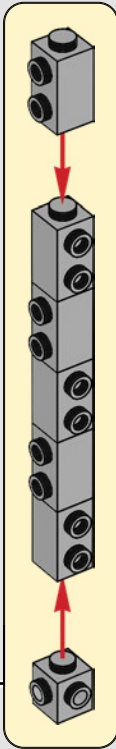

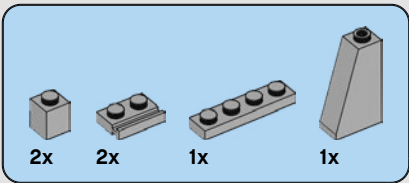

59

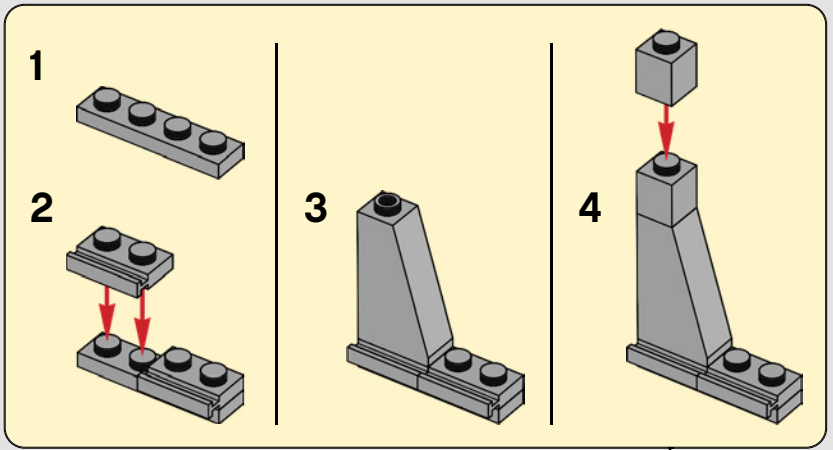



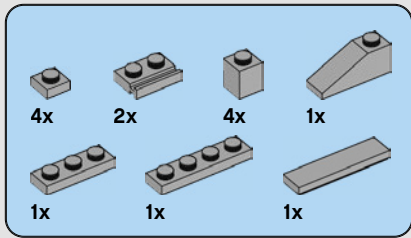

60

1

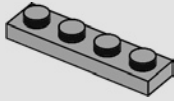

2

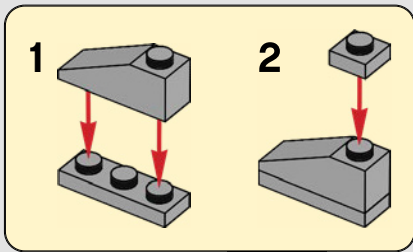
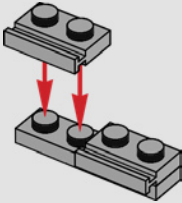

3

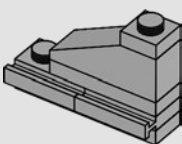

4

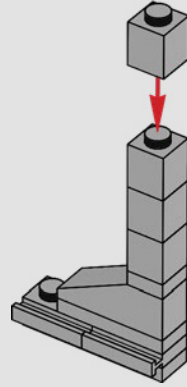

5

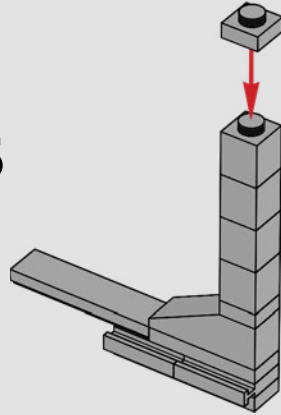

6

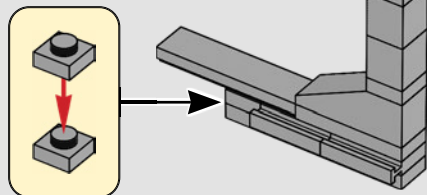

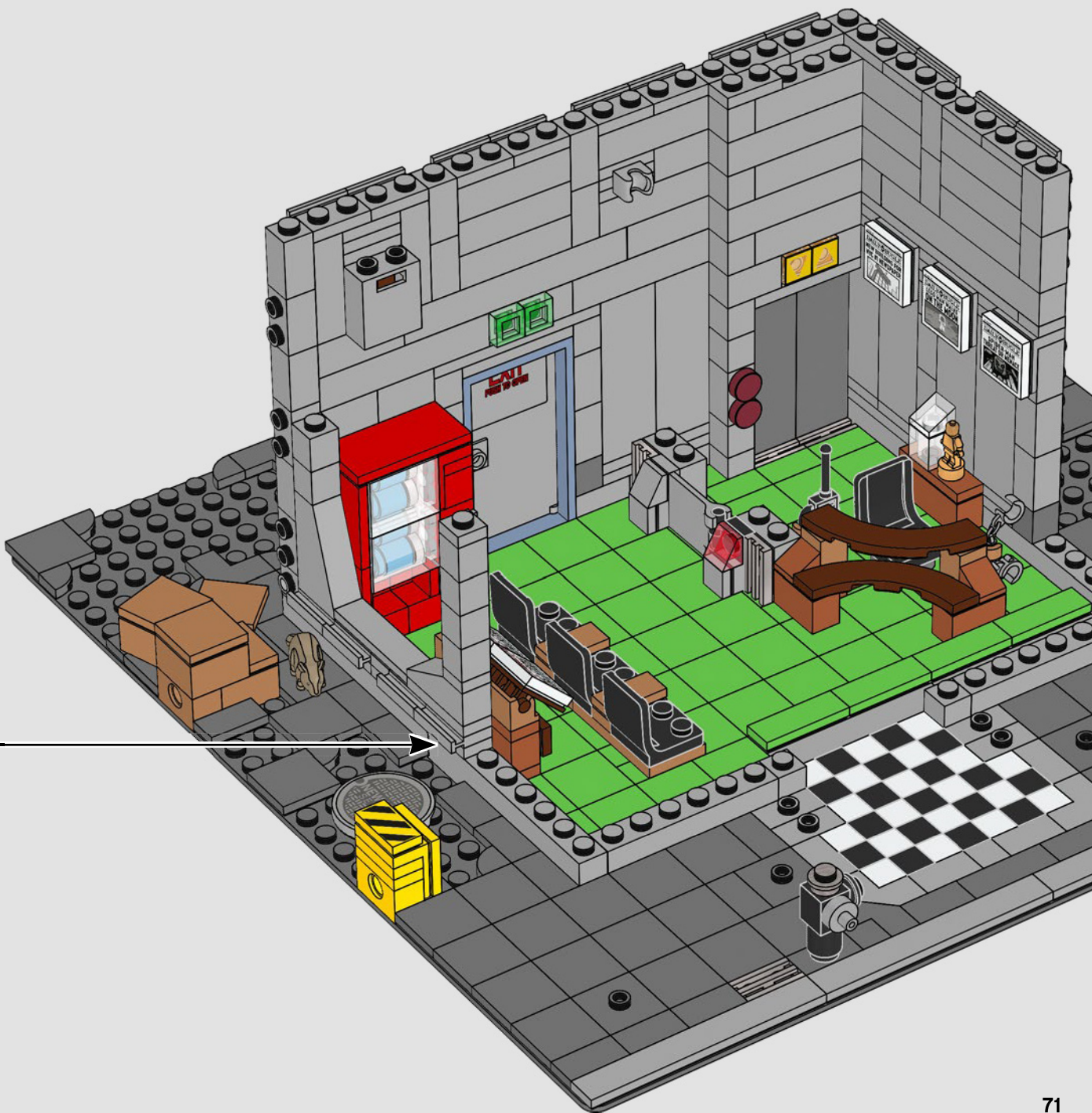



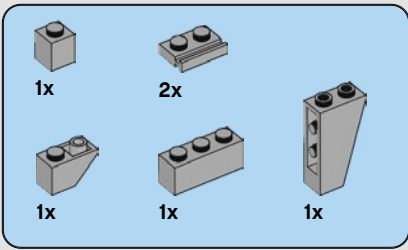

# 61

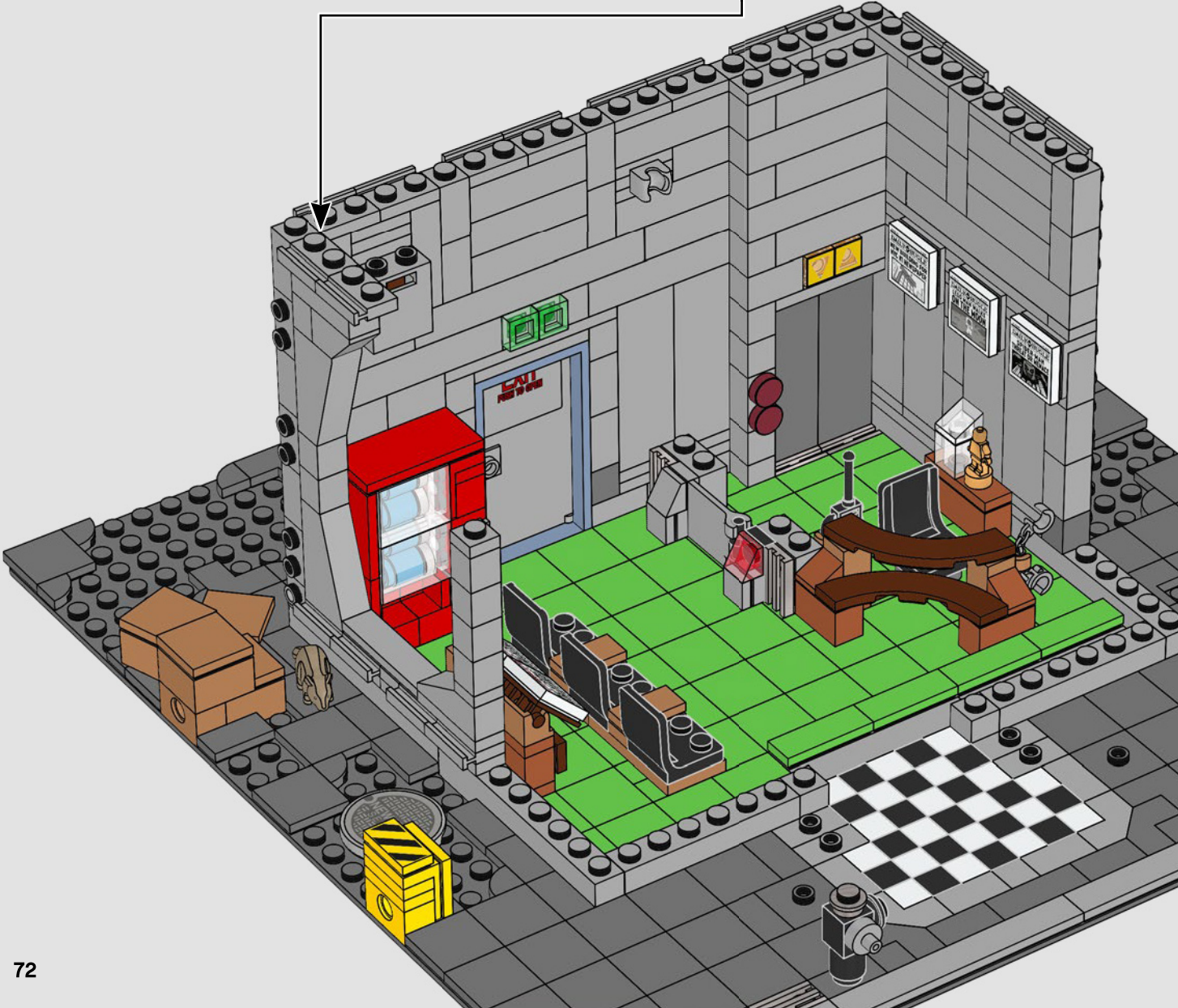
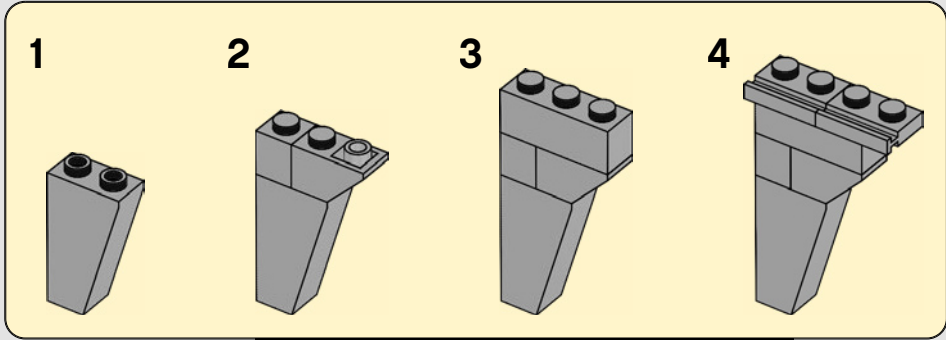

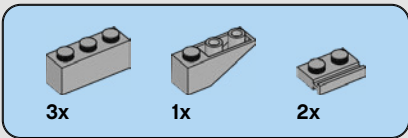

# 62

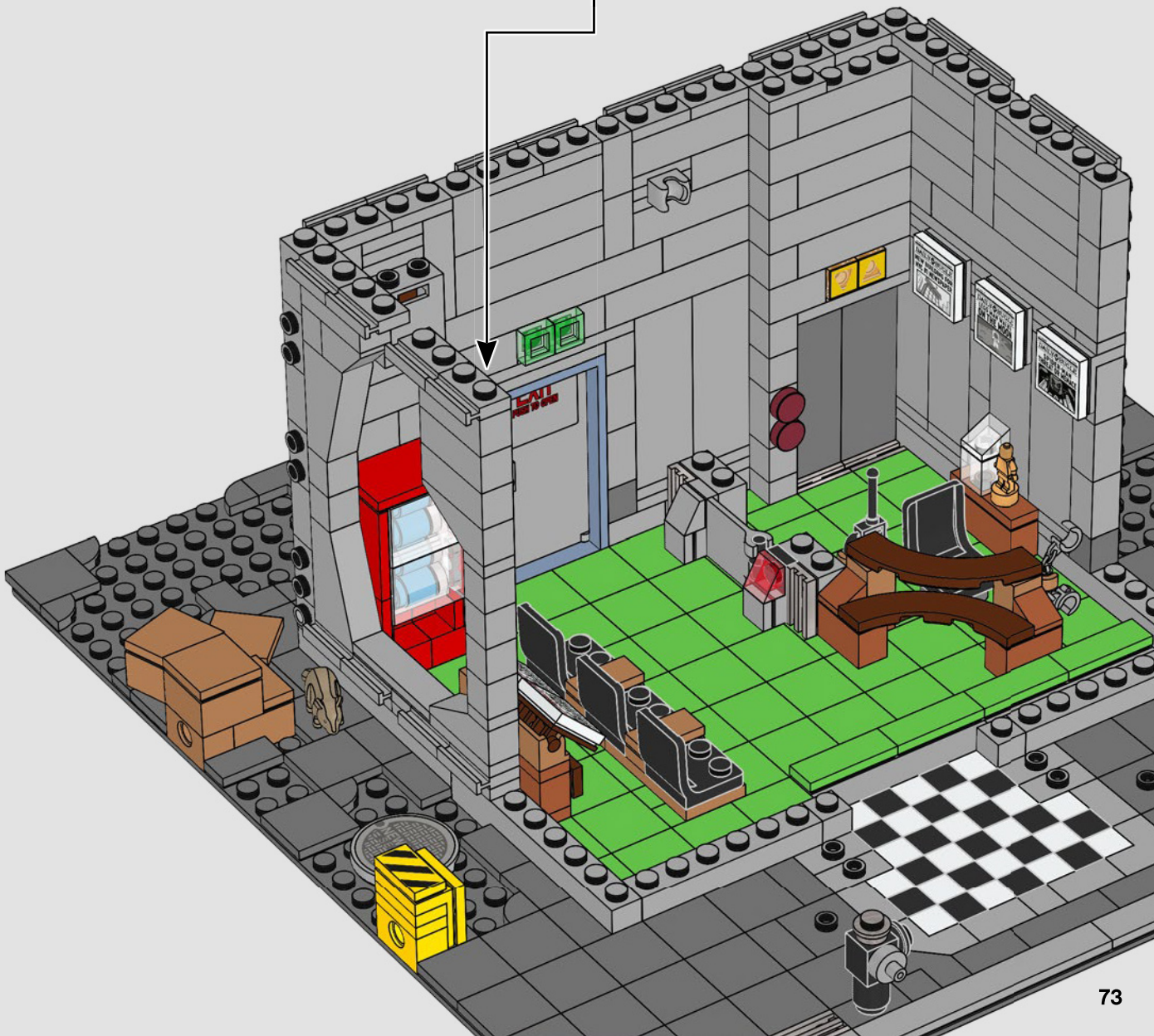
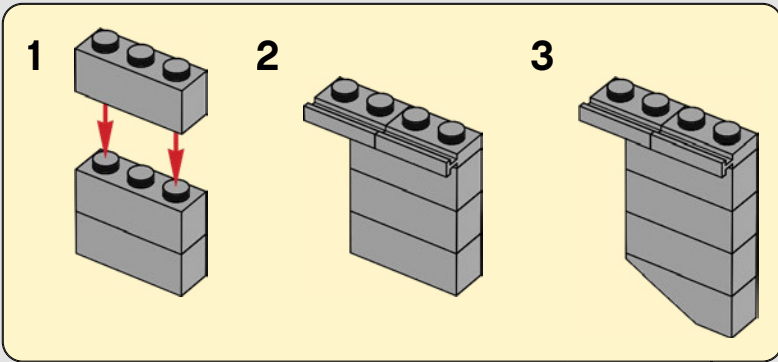





12x



2x

63

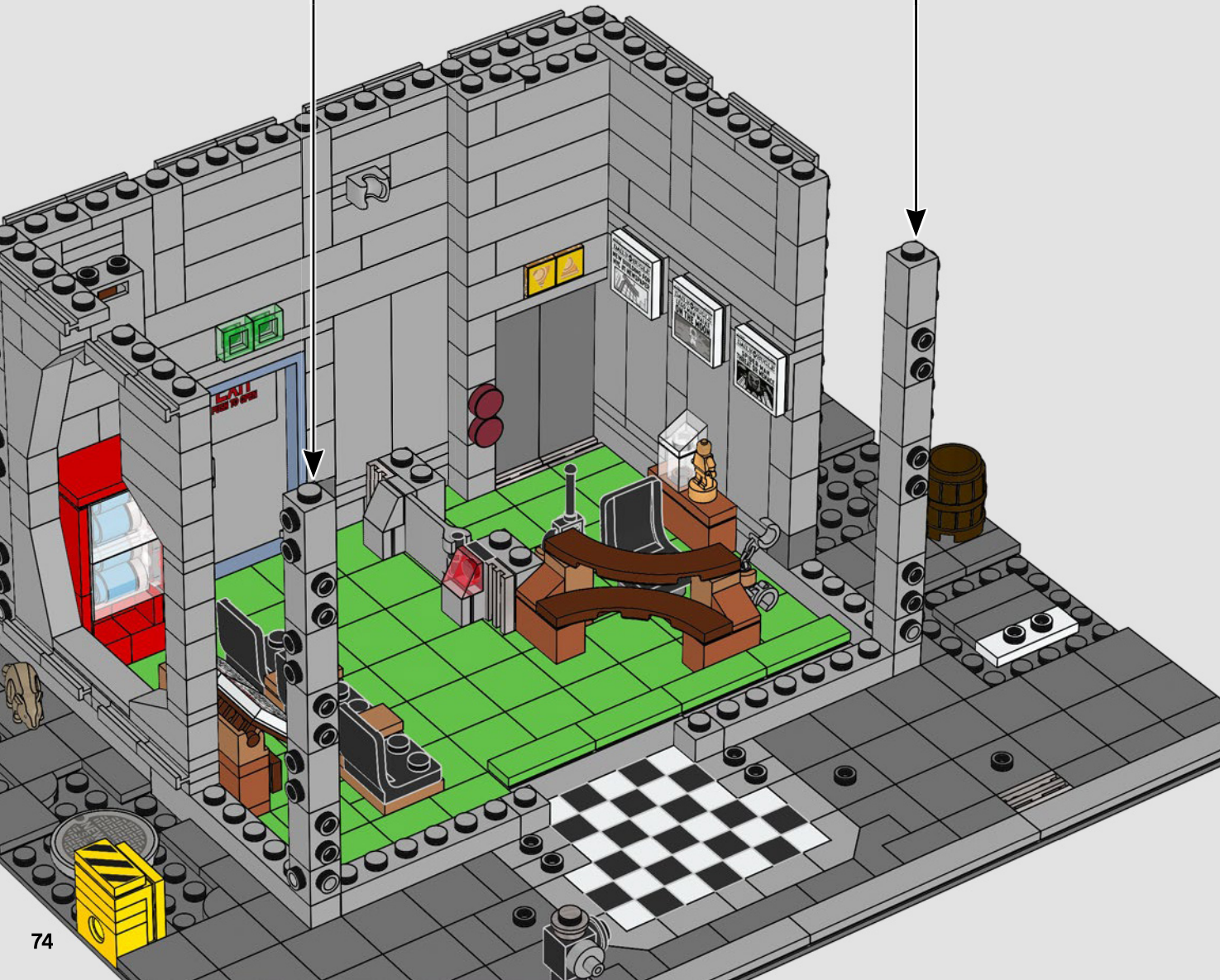
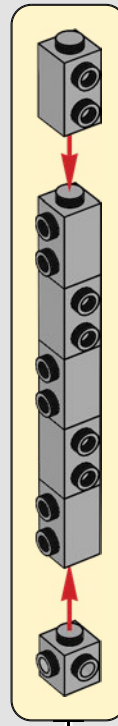
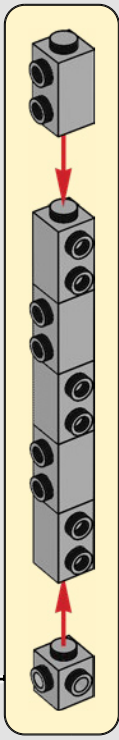

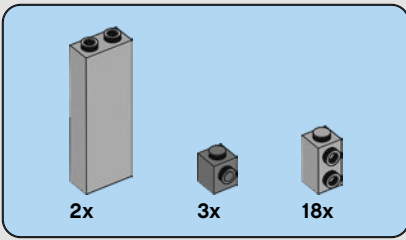

64

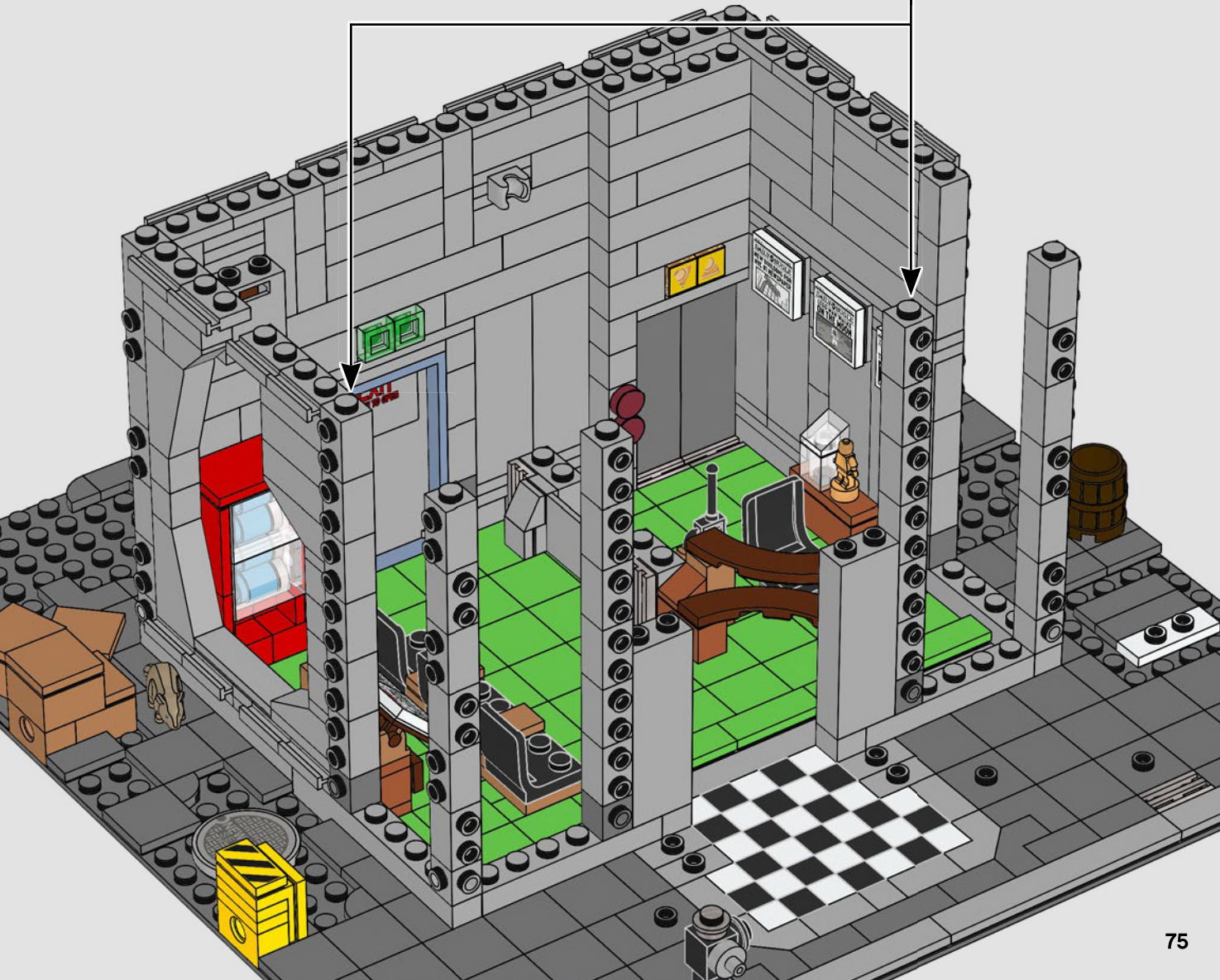
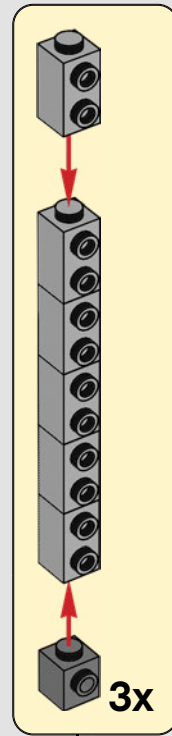



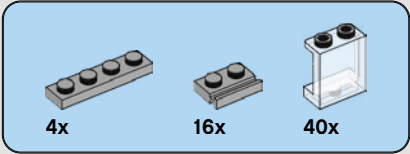
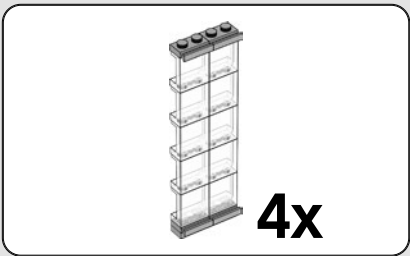

# 65

1

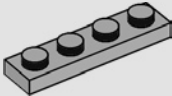

2

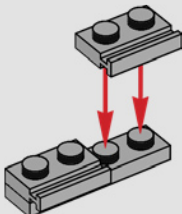

3

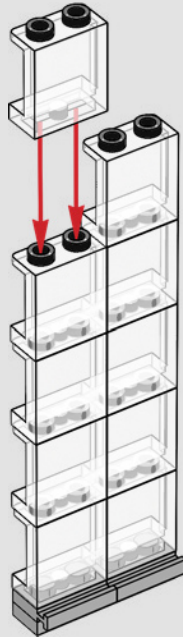

4

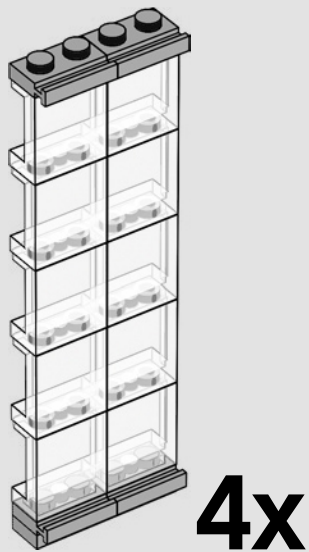

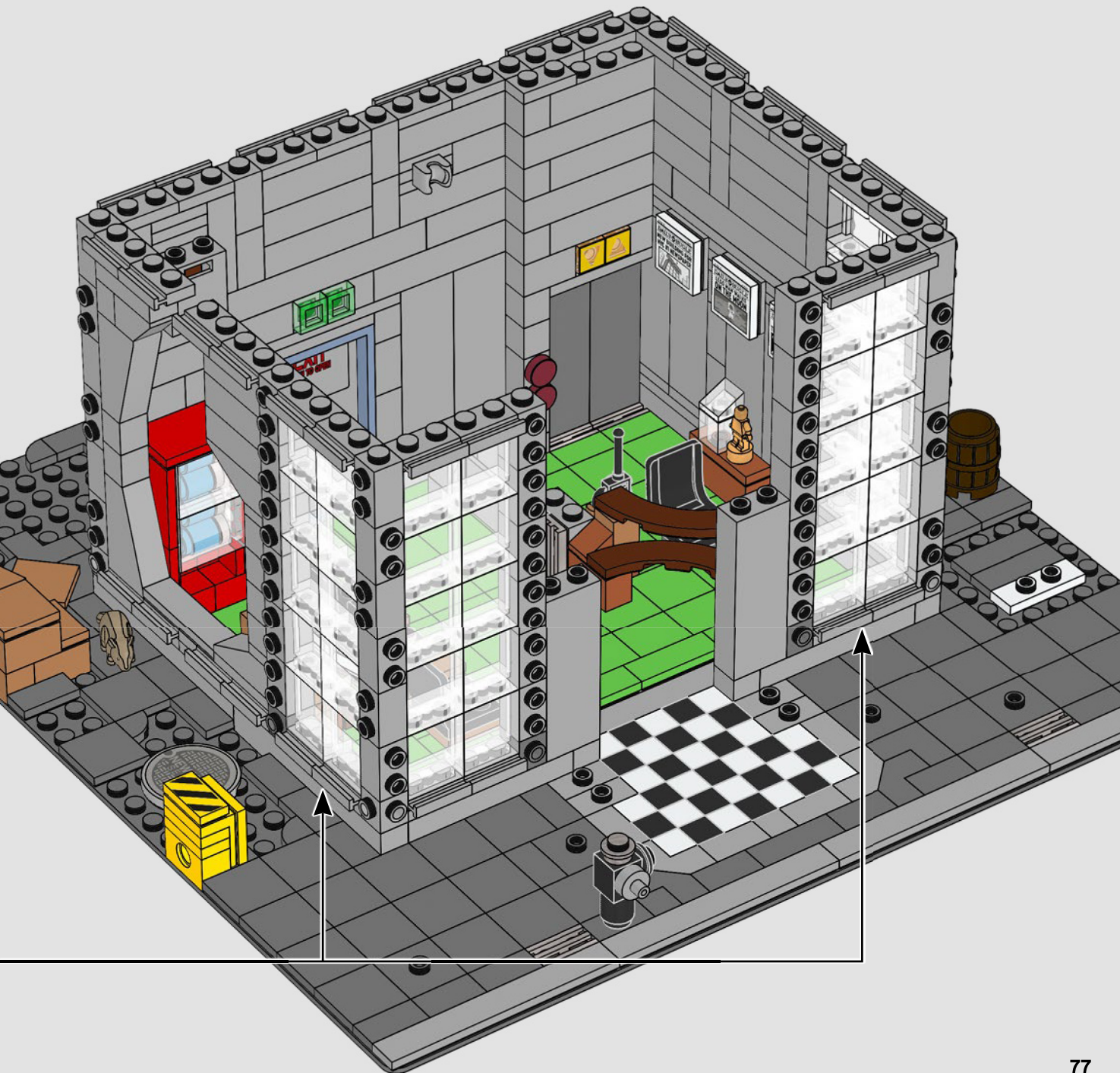



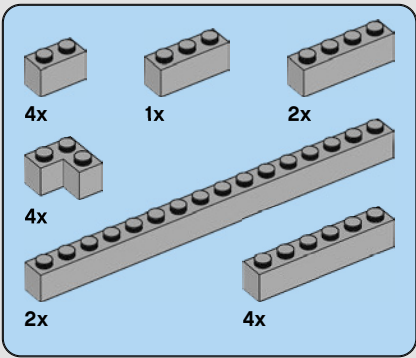

66

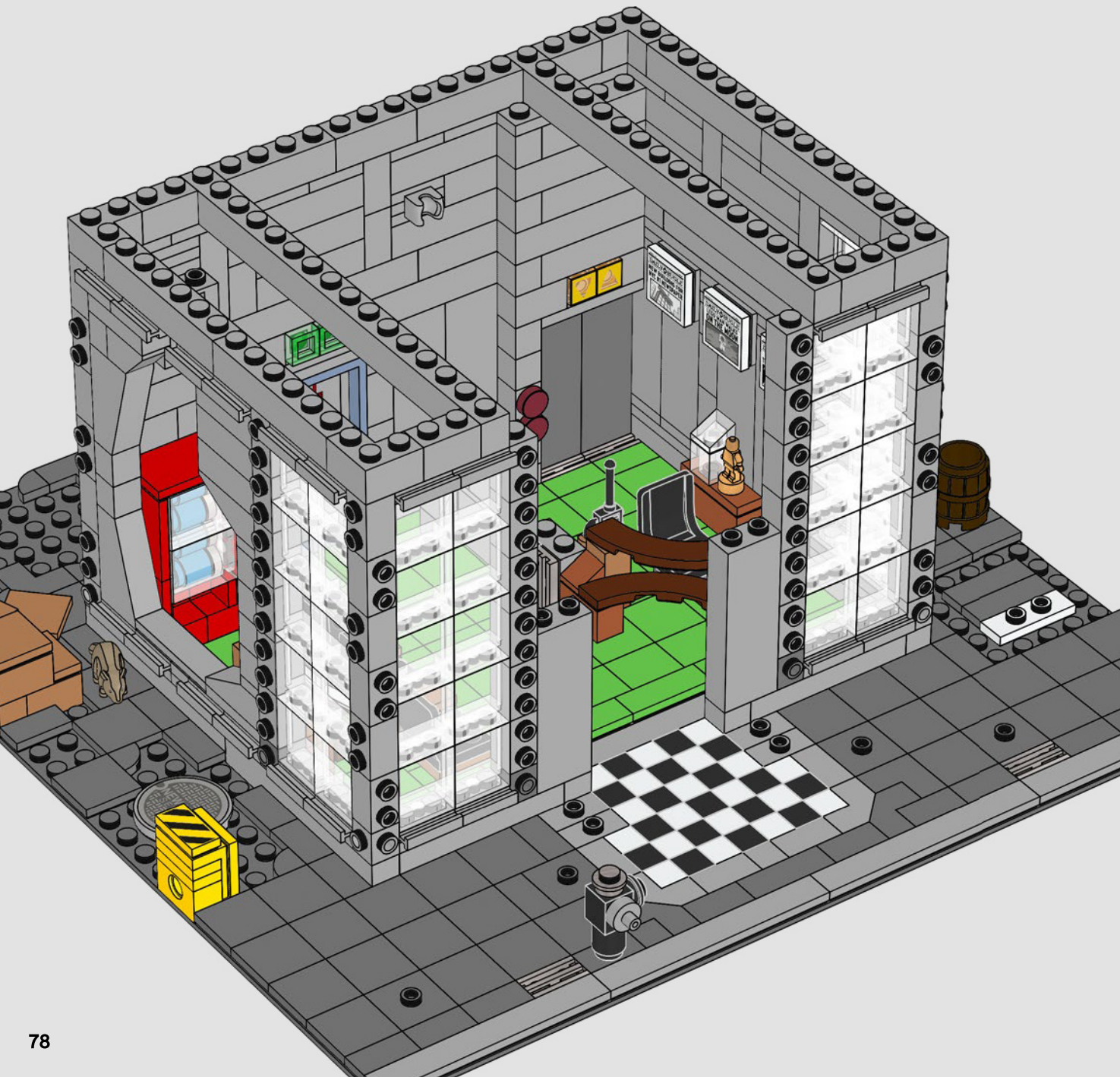



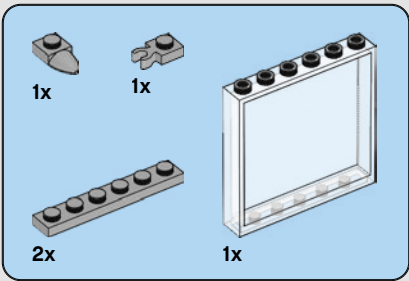

67

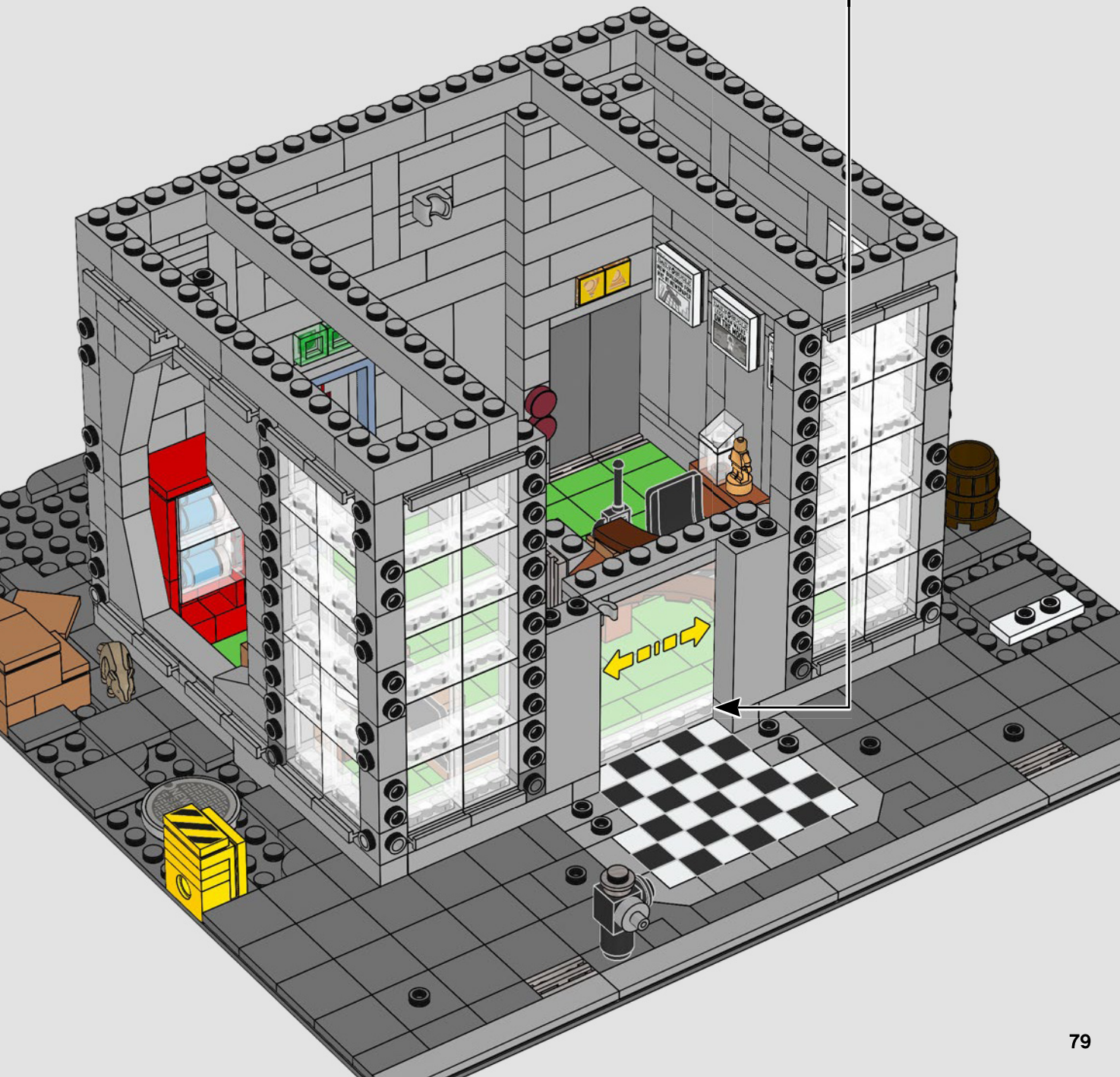
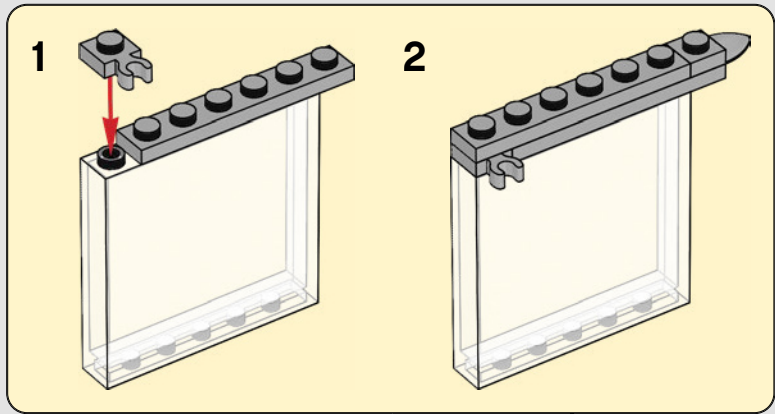



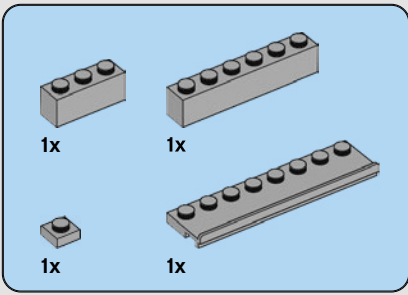

68

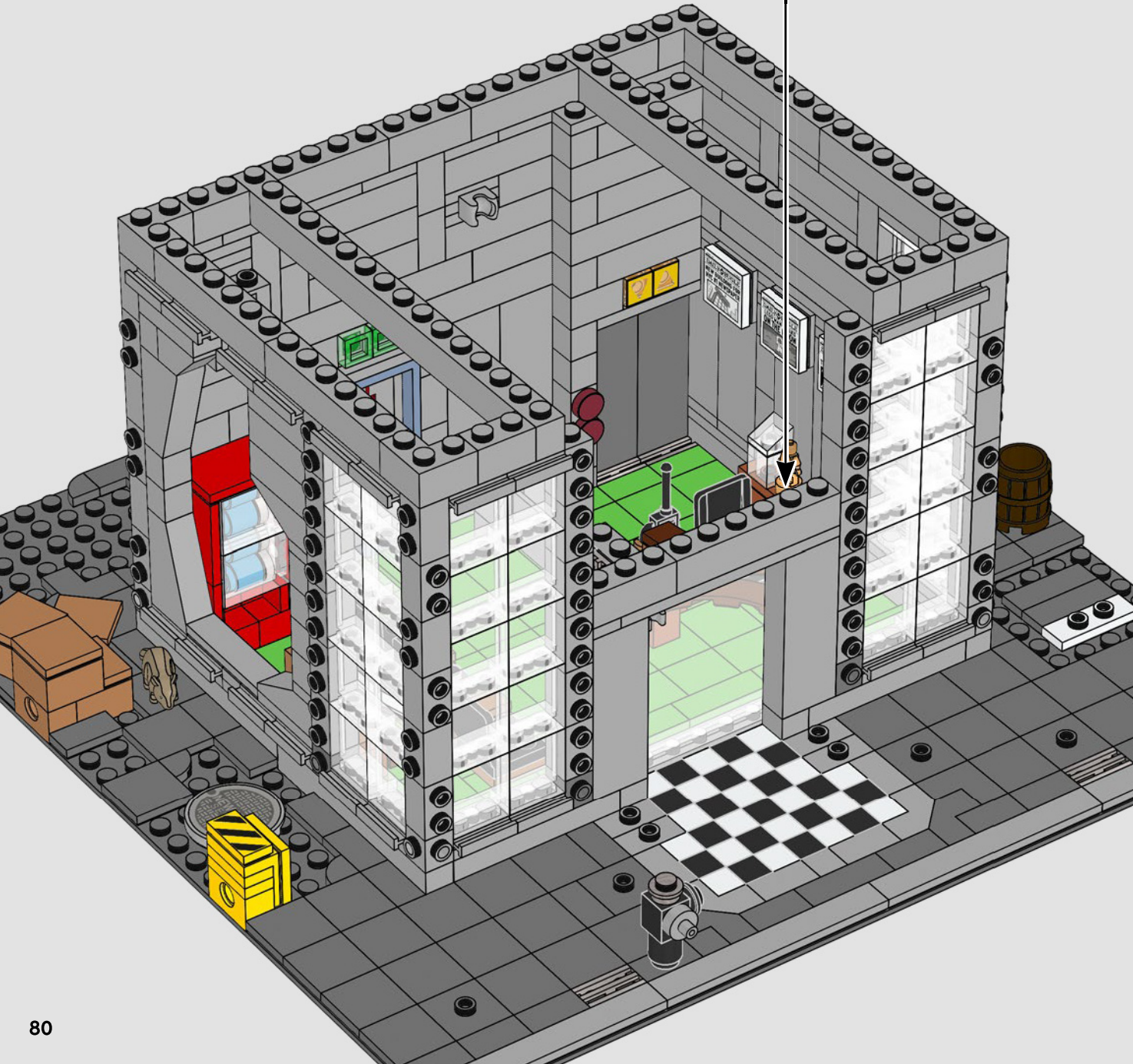
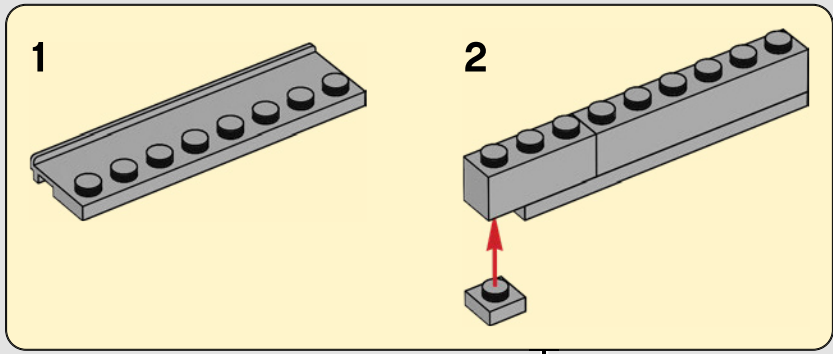



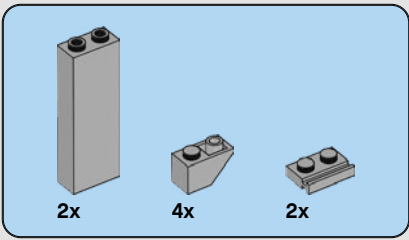

69

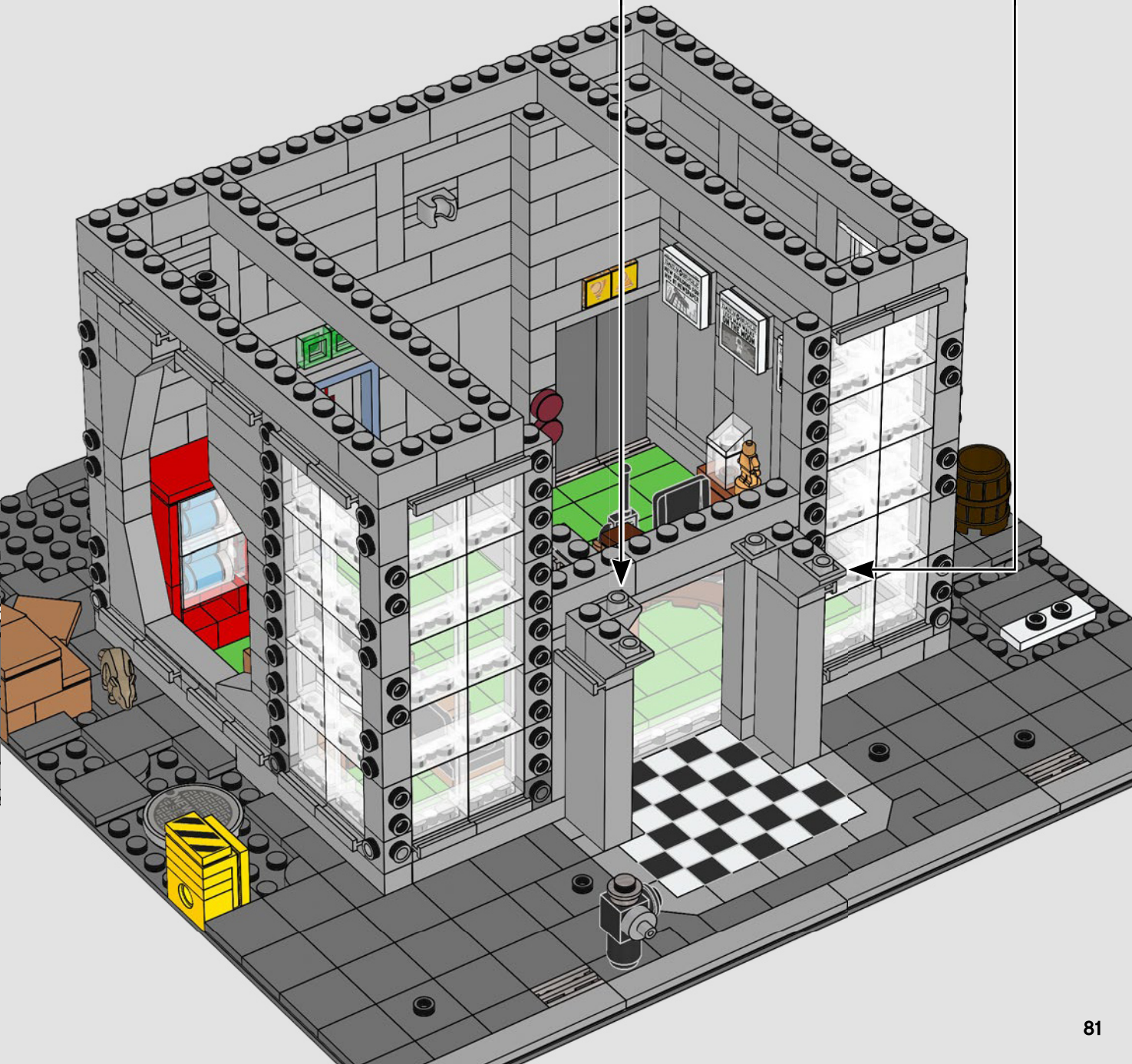
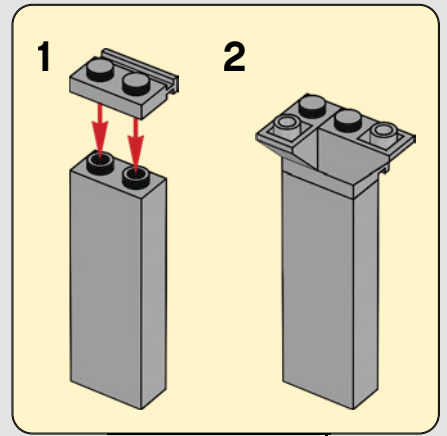
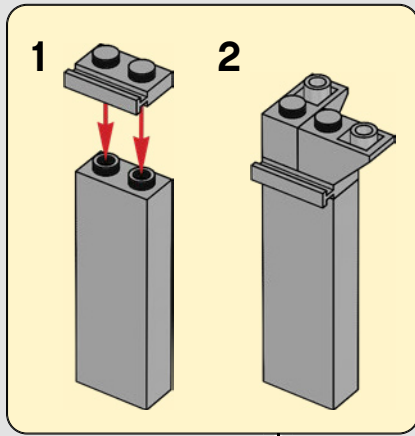



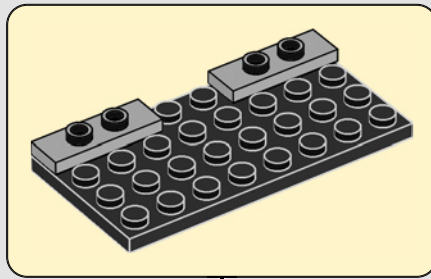
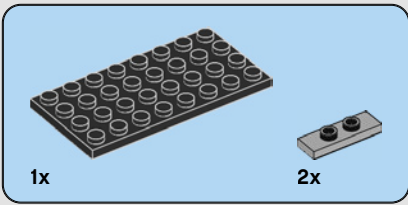

70

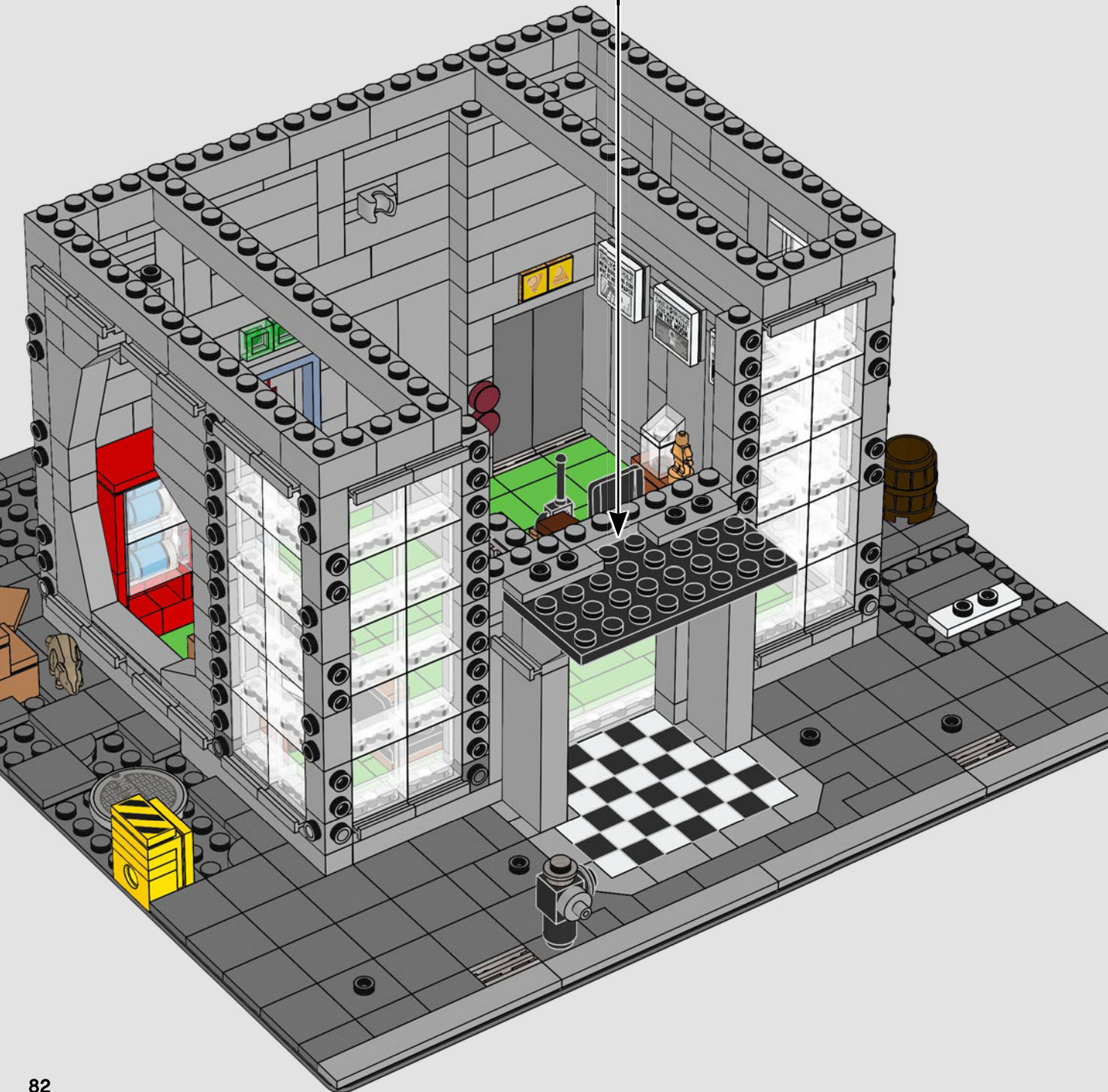

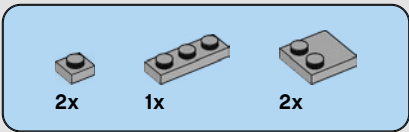

71

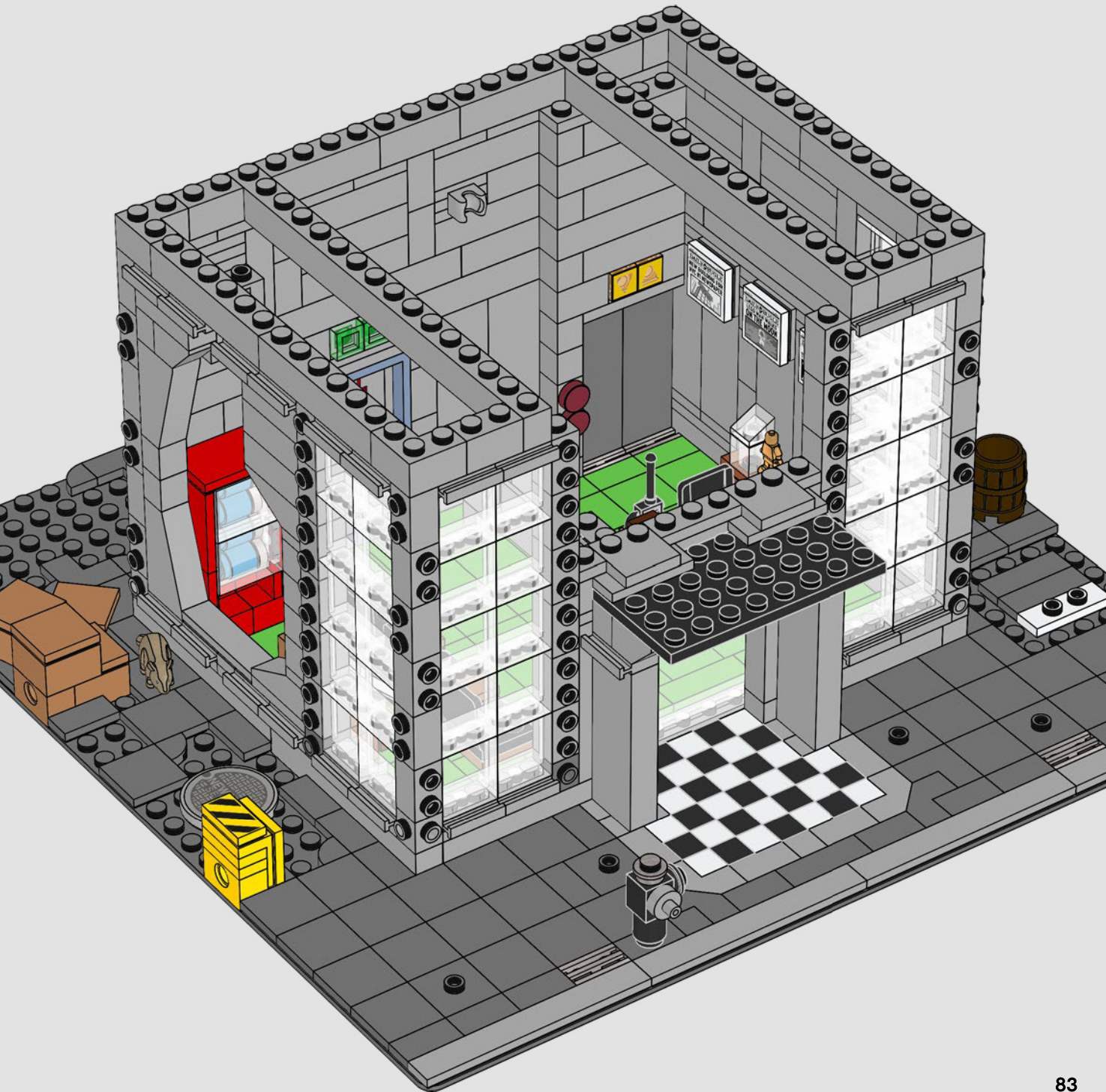



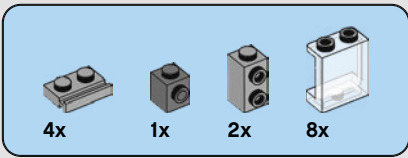

72

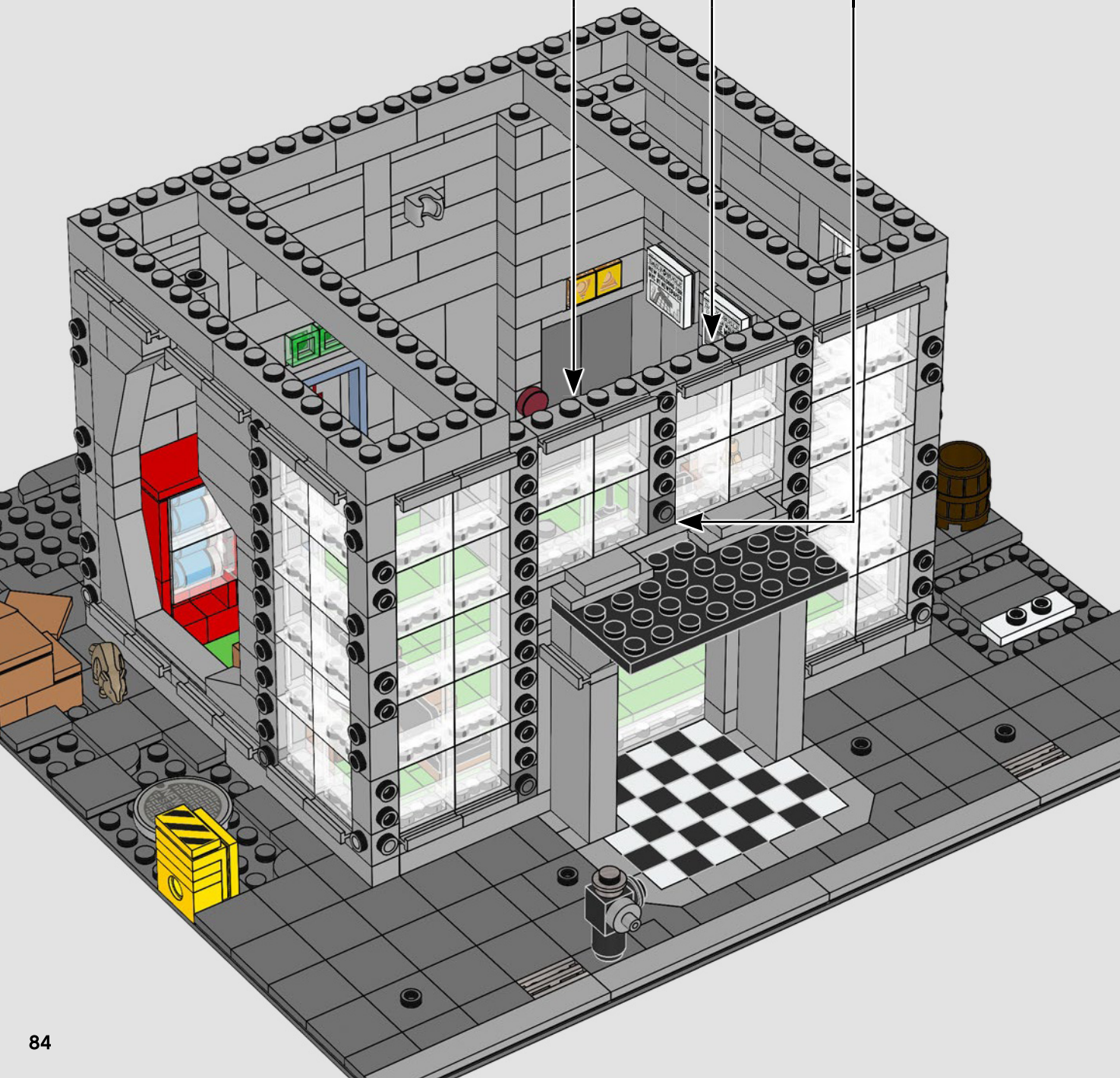
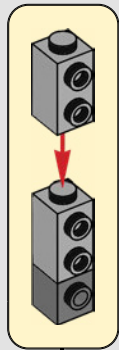
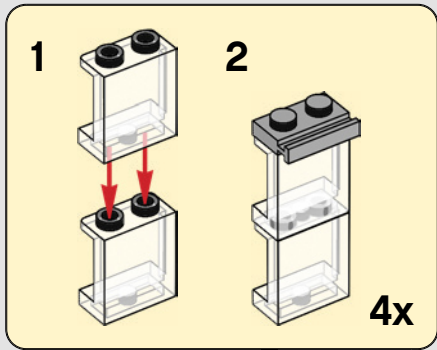

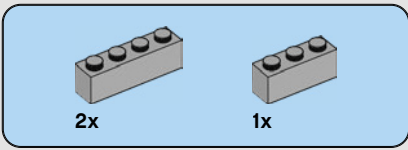

73

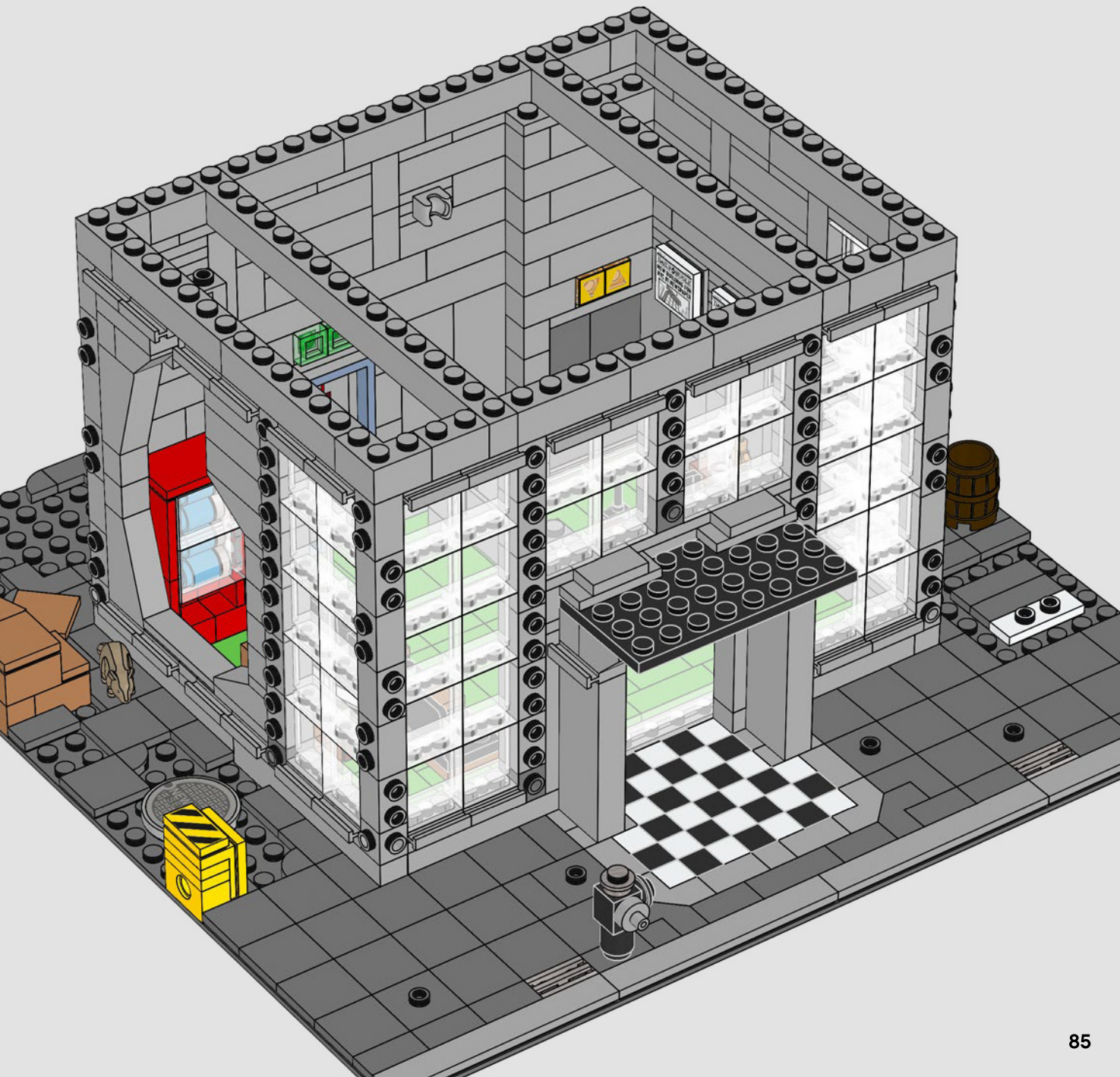





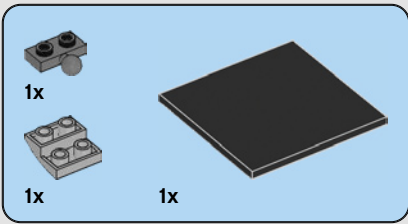

74

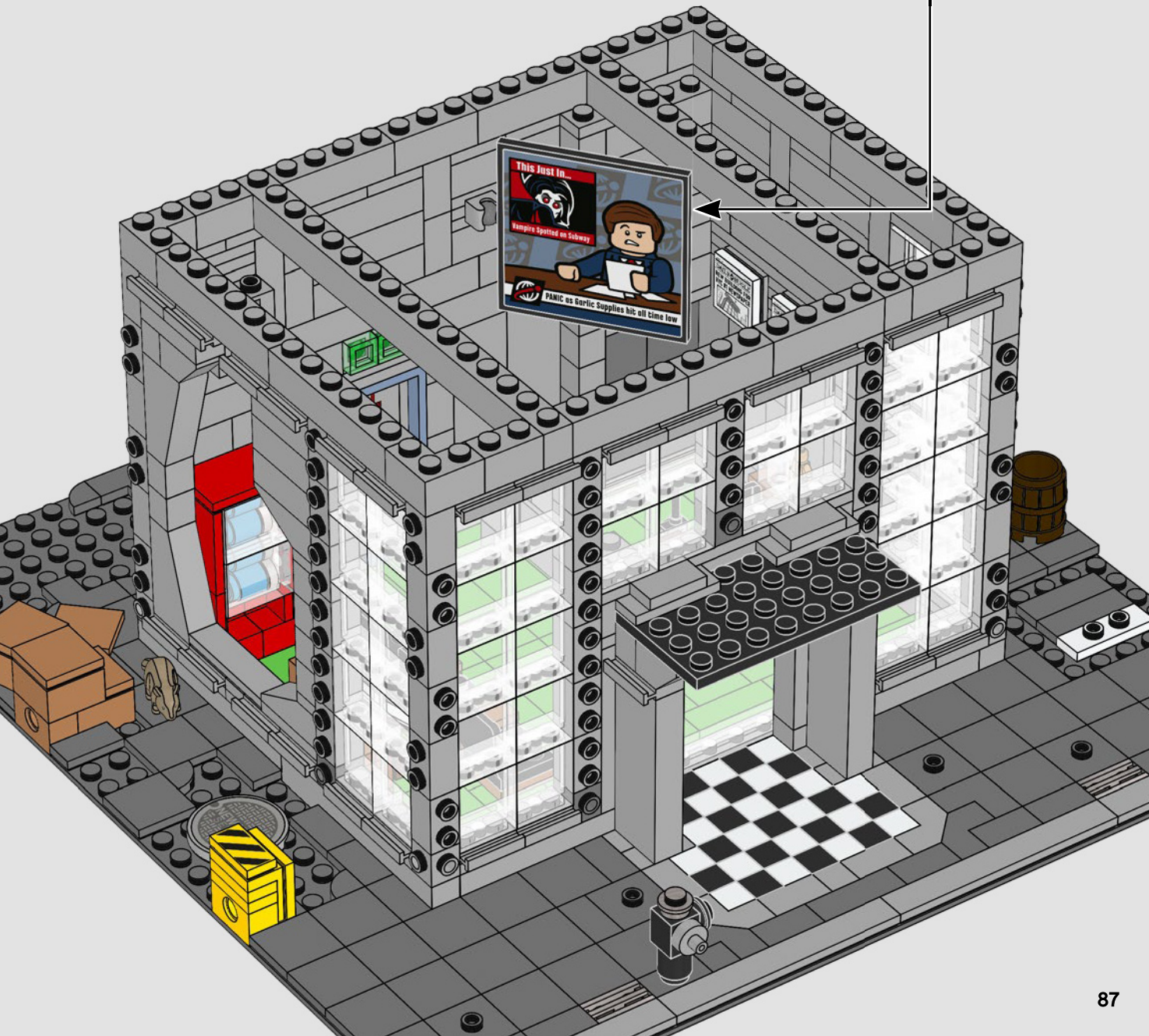
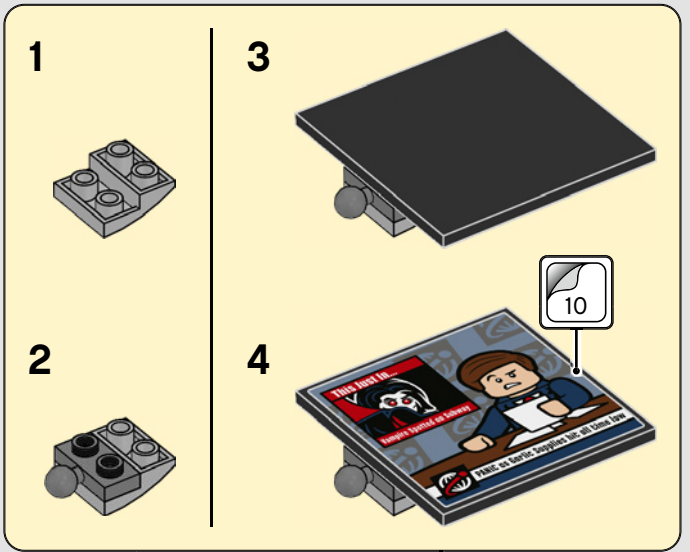



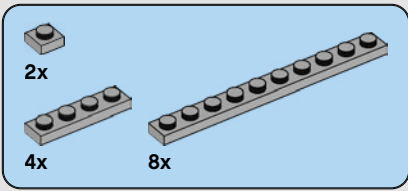

75

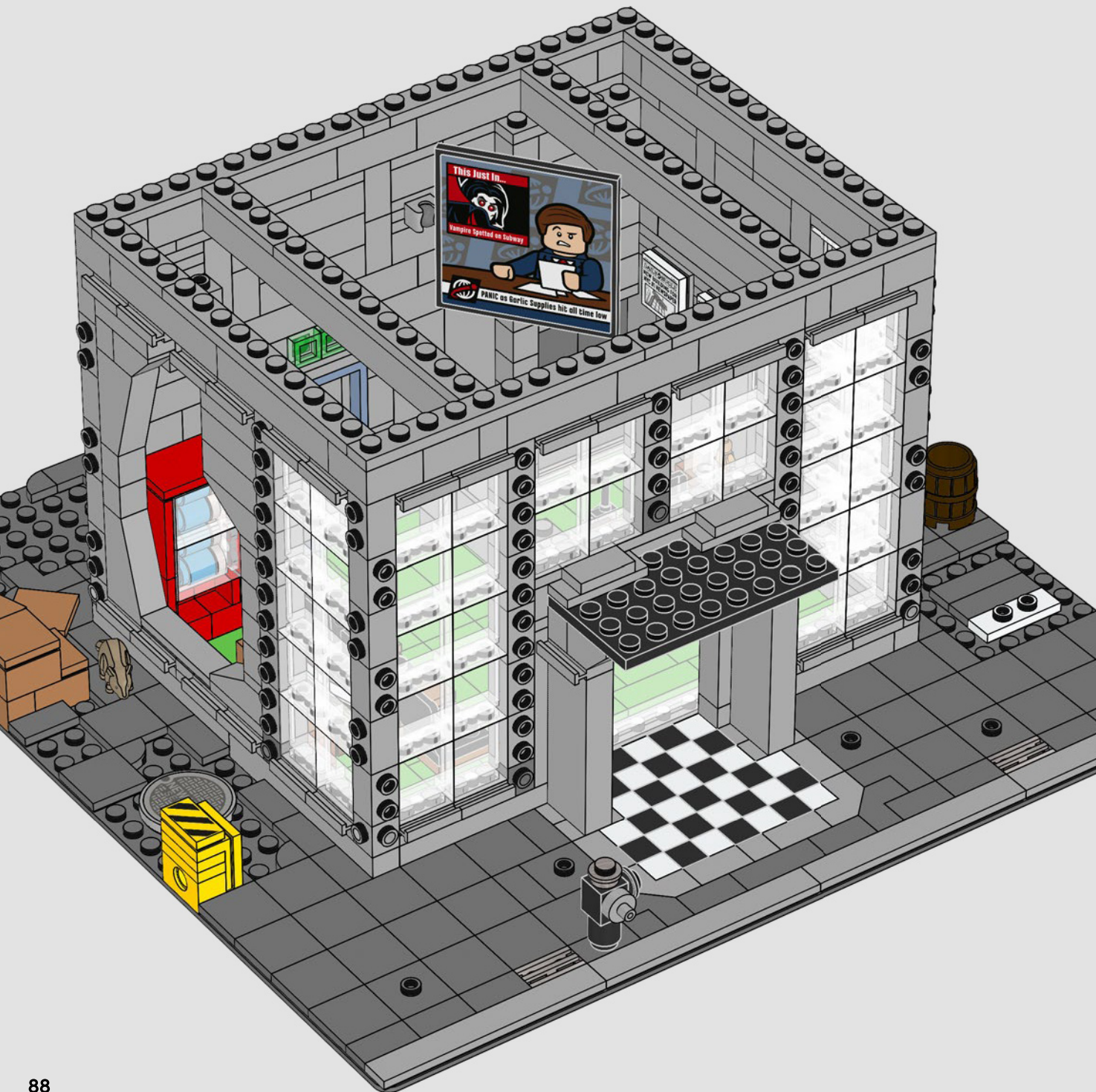



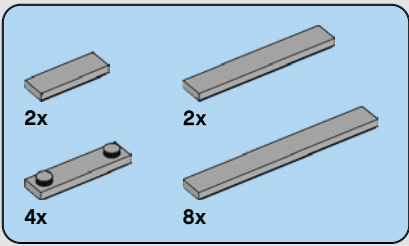

76

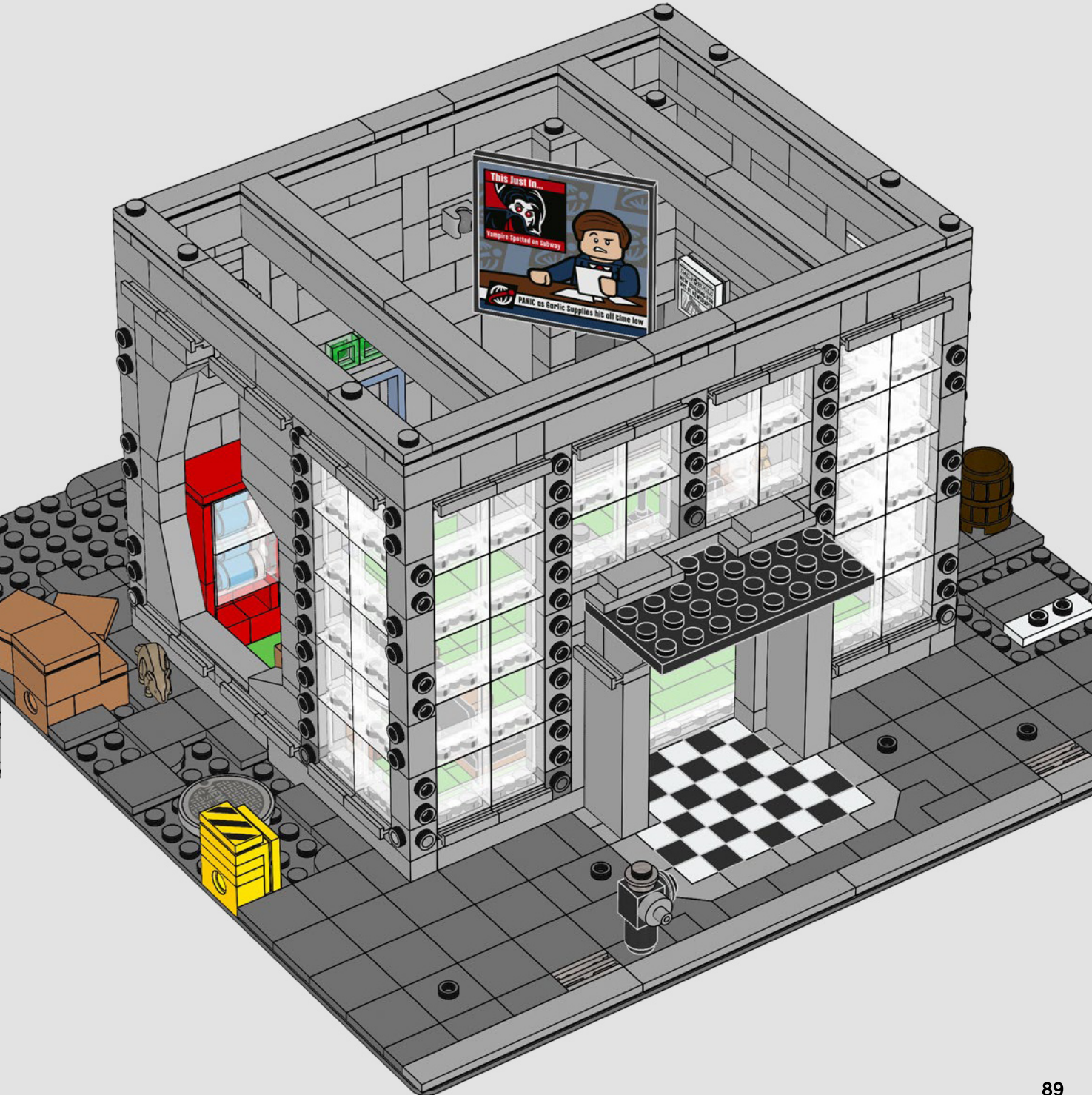



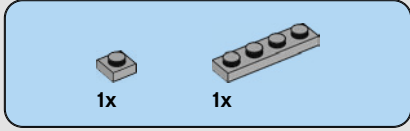
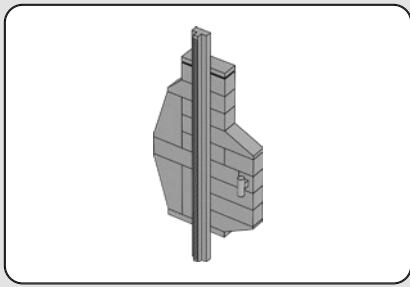

77

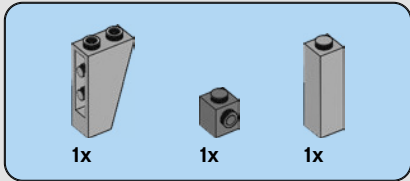
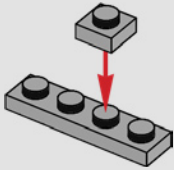

78

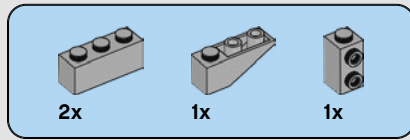
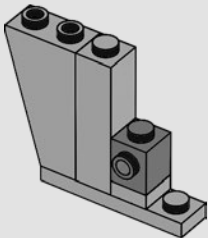

79

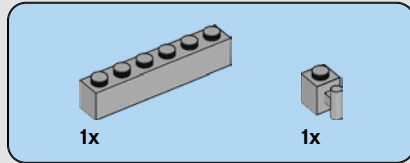
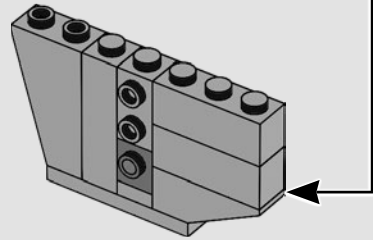
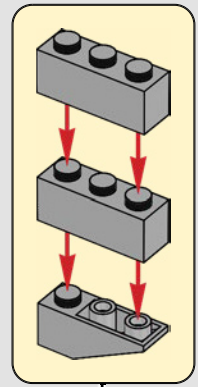

80

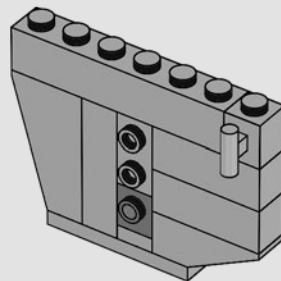

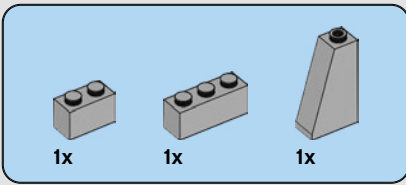

81

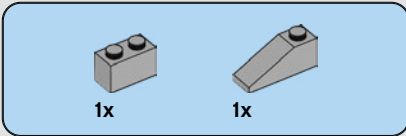
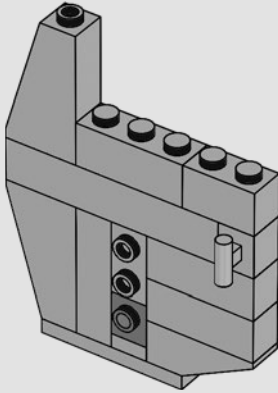

82

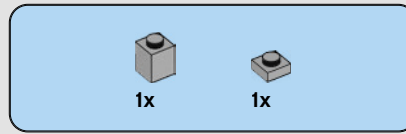
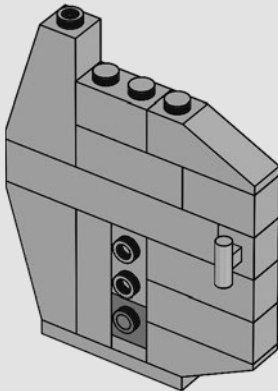

83

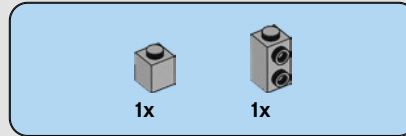
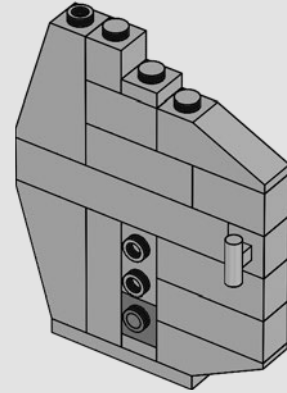

84

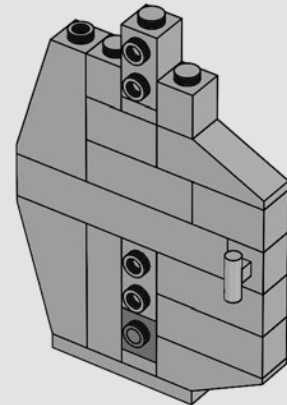



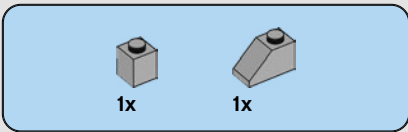

85

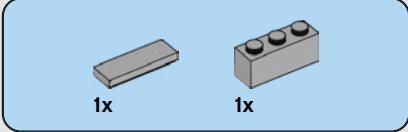
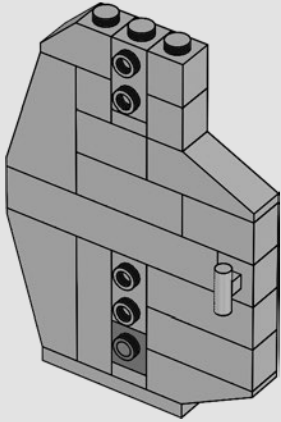

86

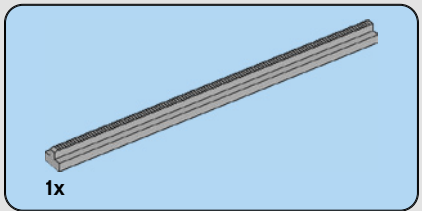
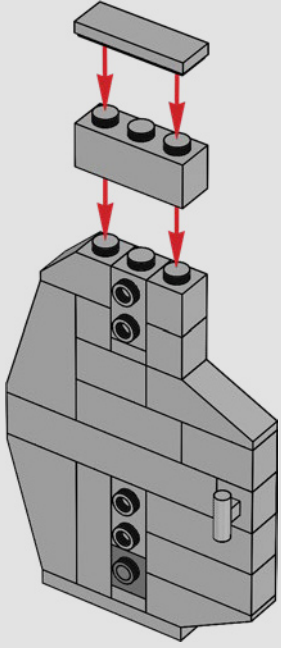

87

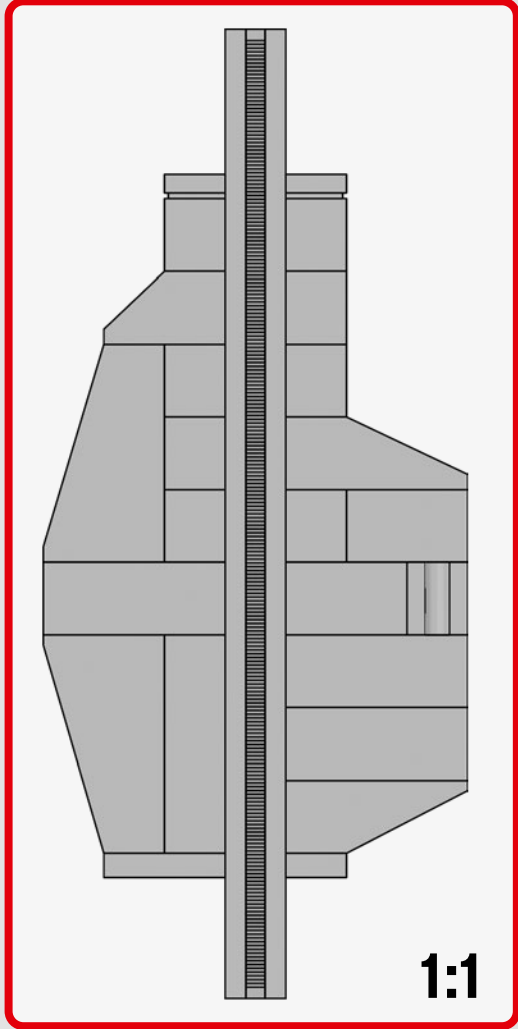
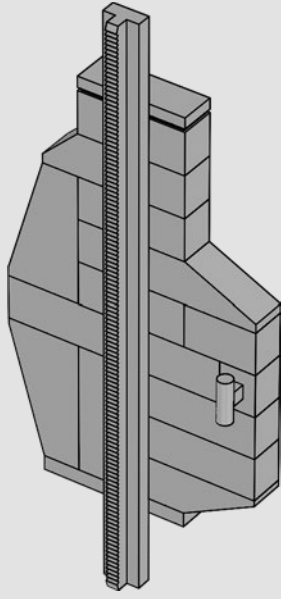

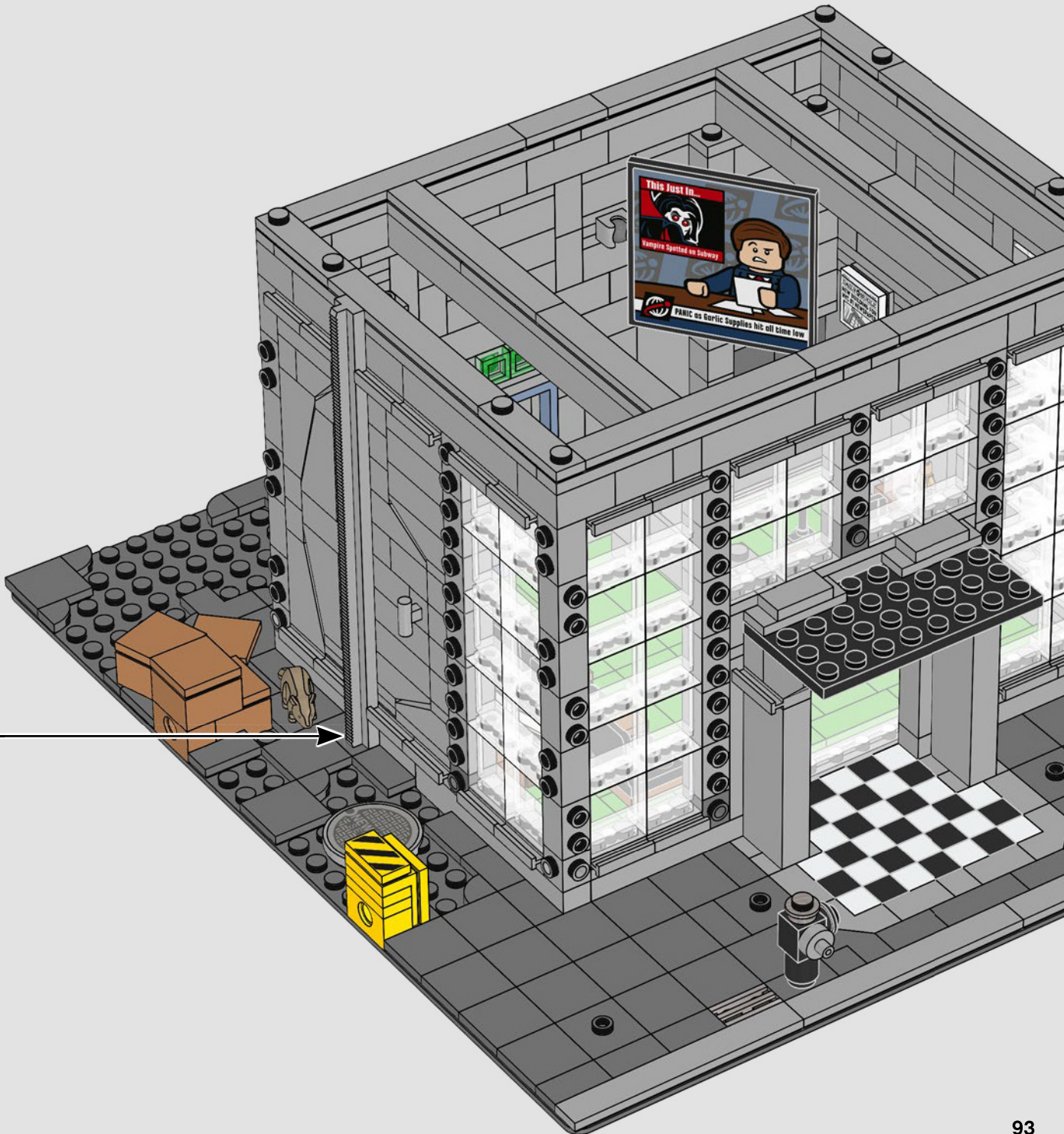



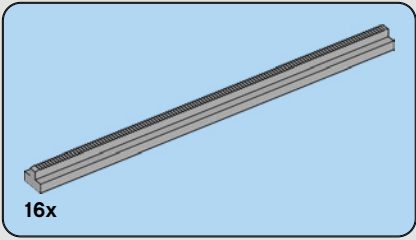

89





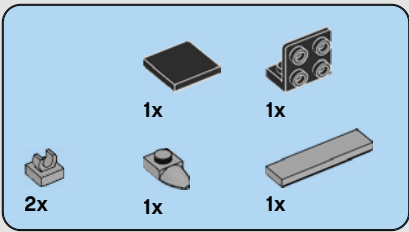

90

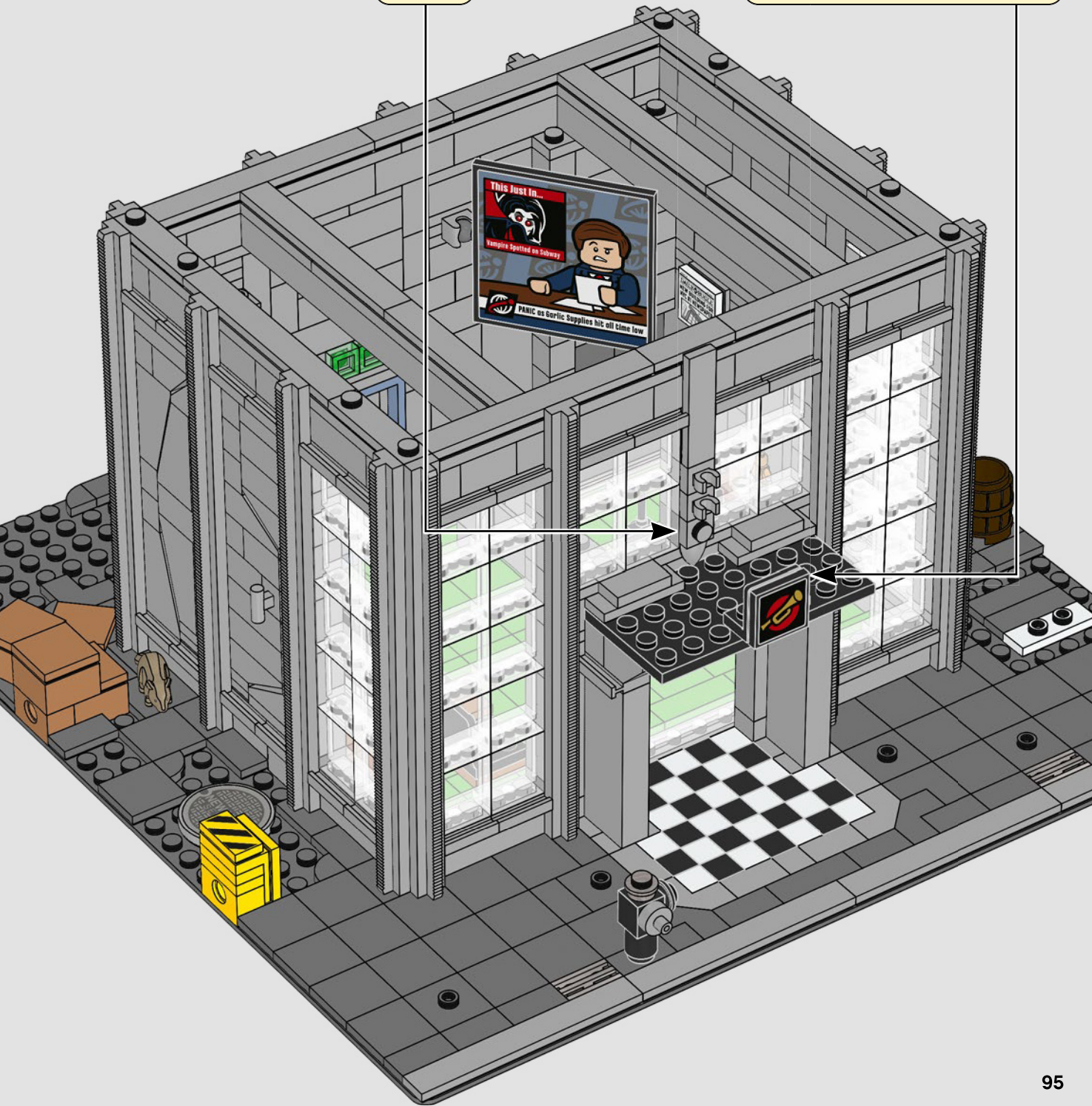
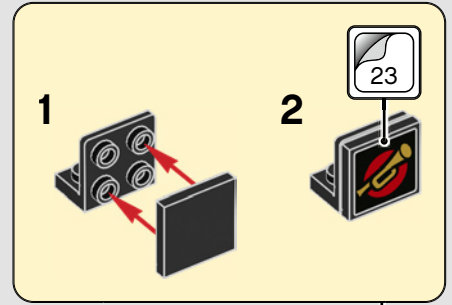



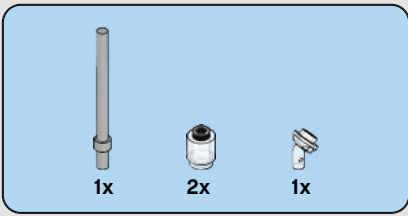

91

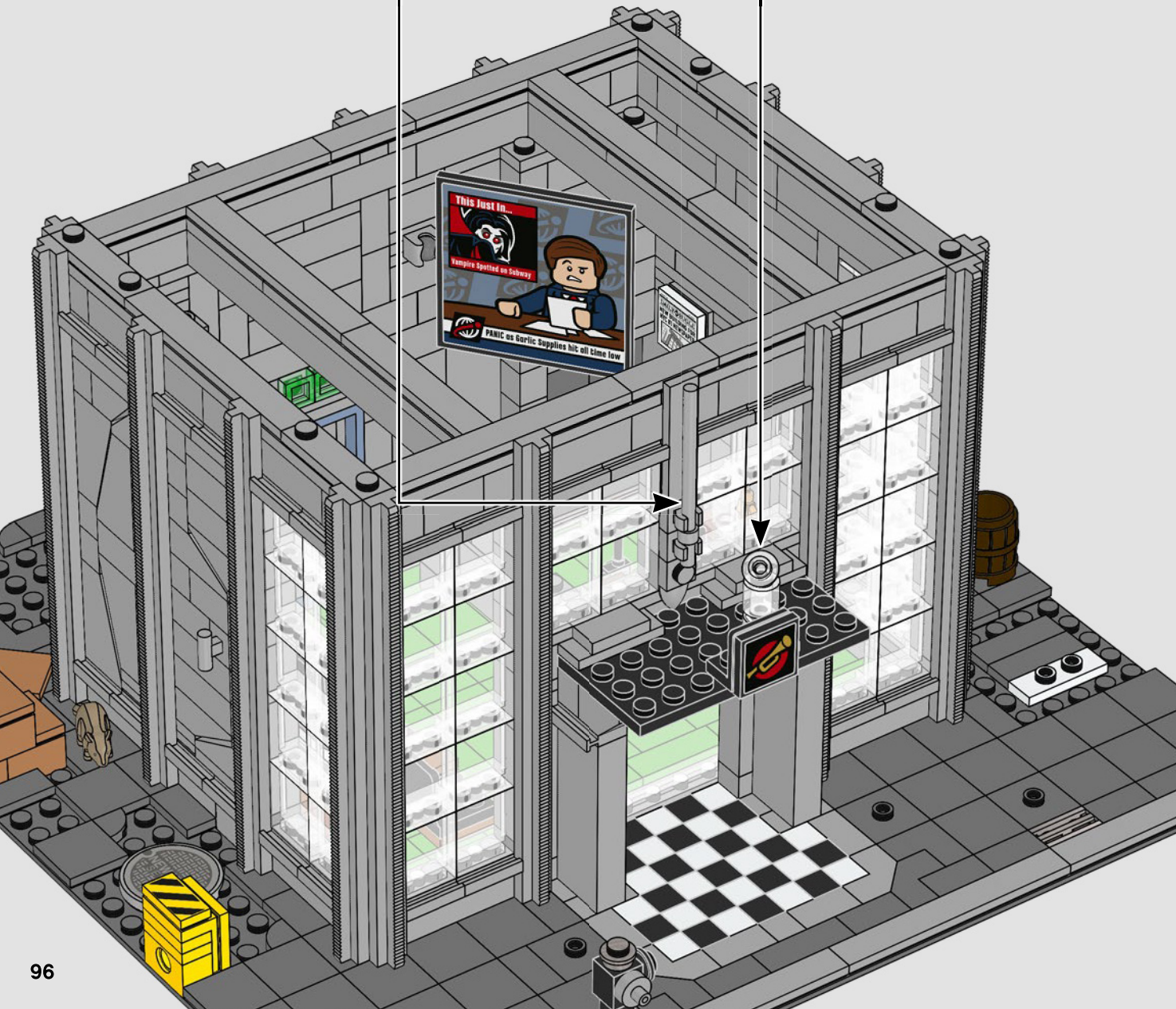
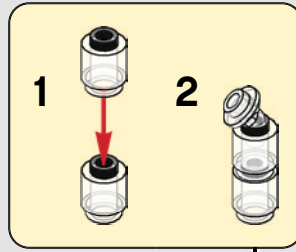
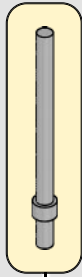



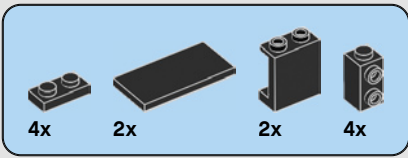

92

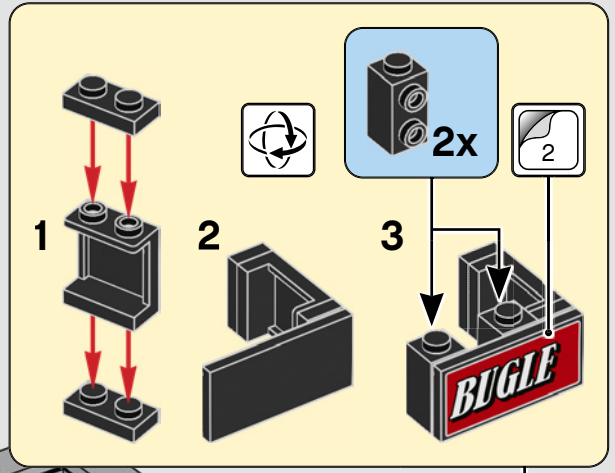
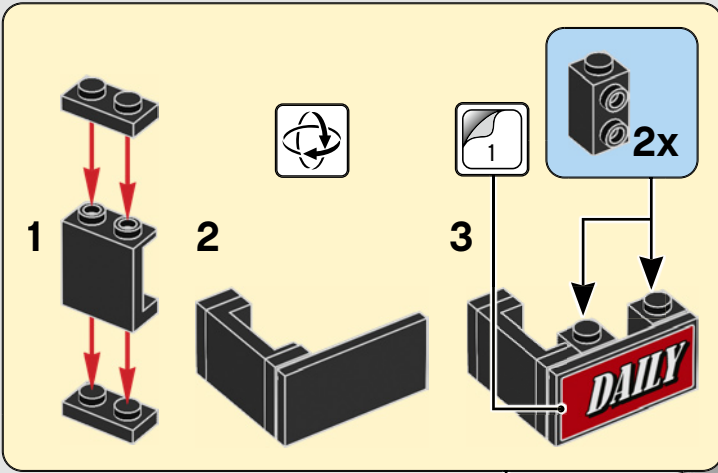



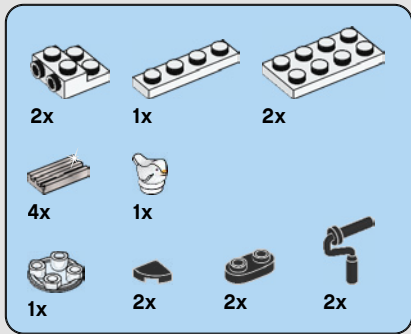

93

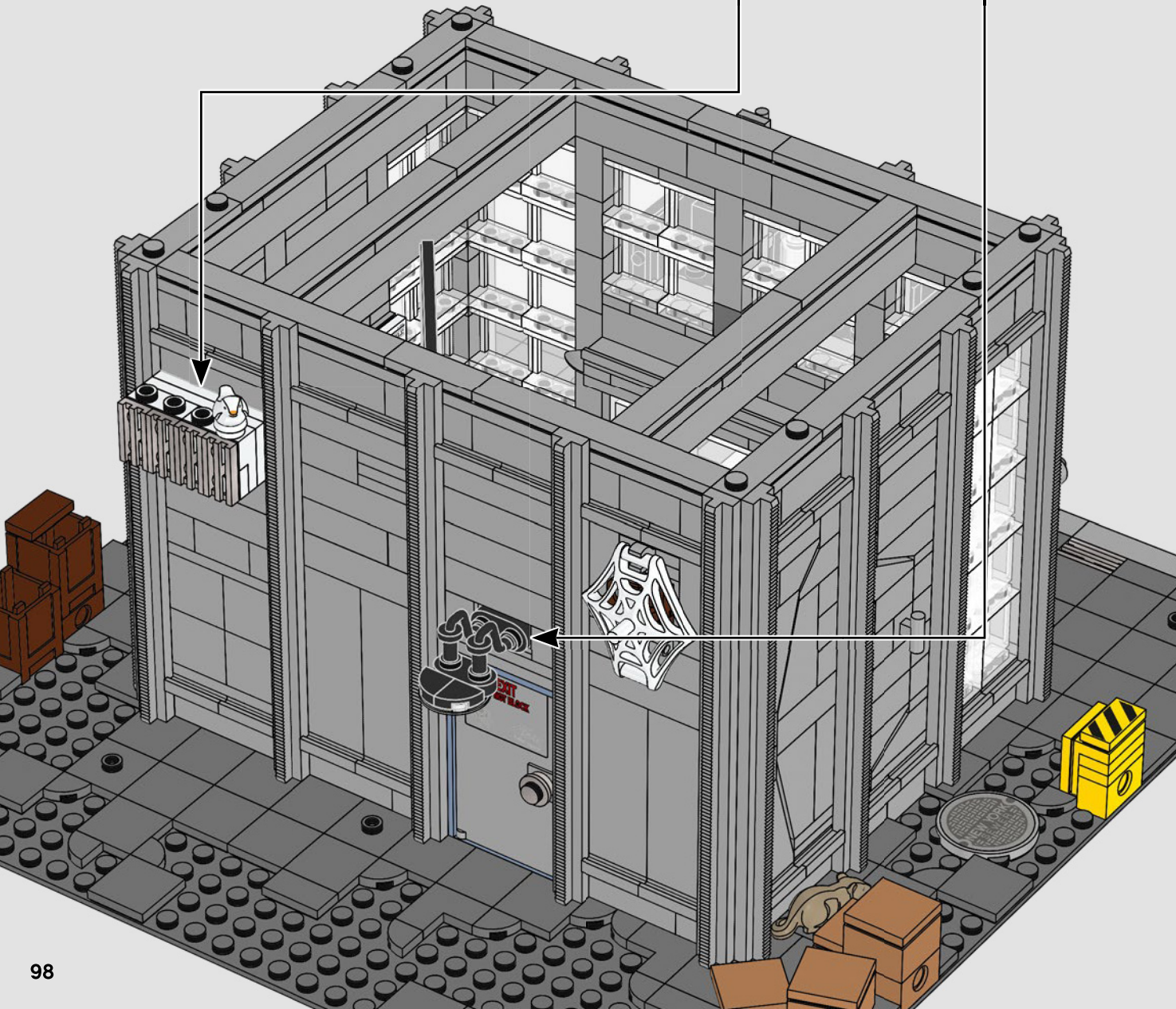
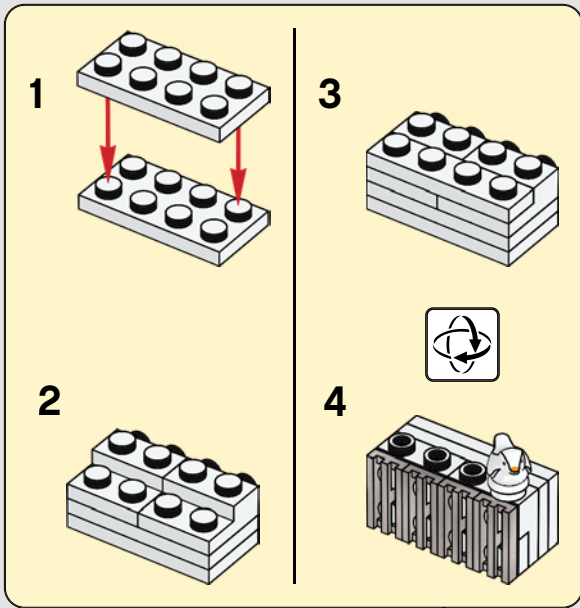



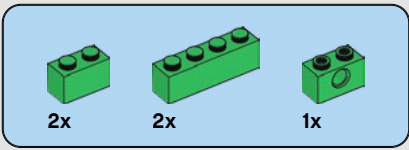

94

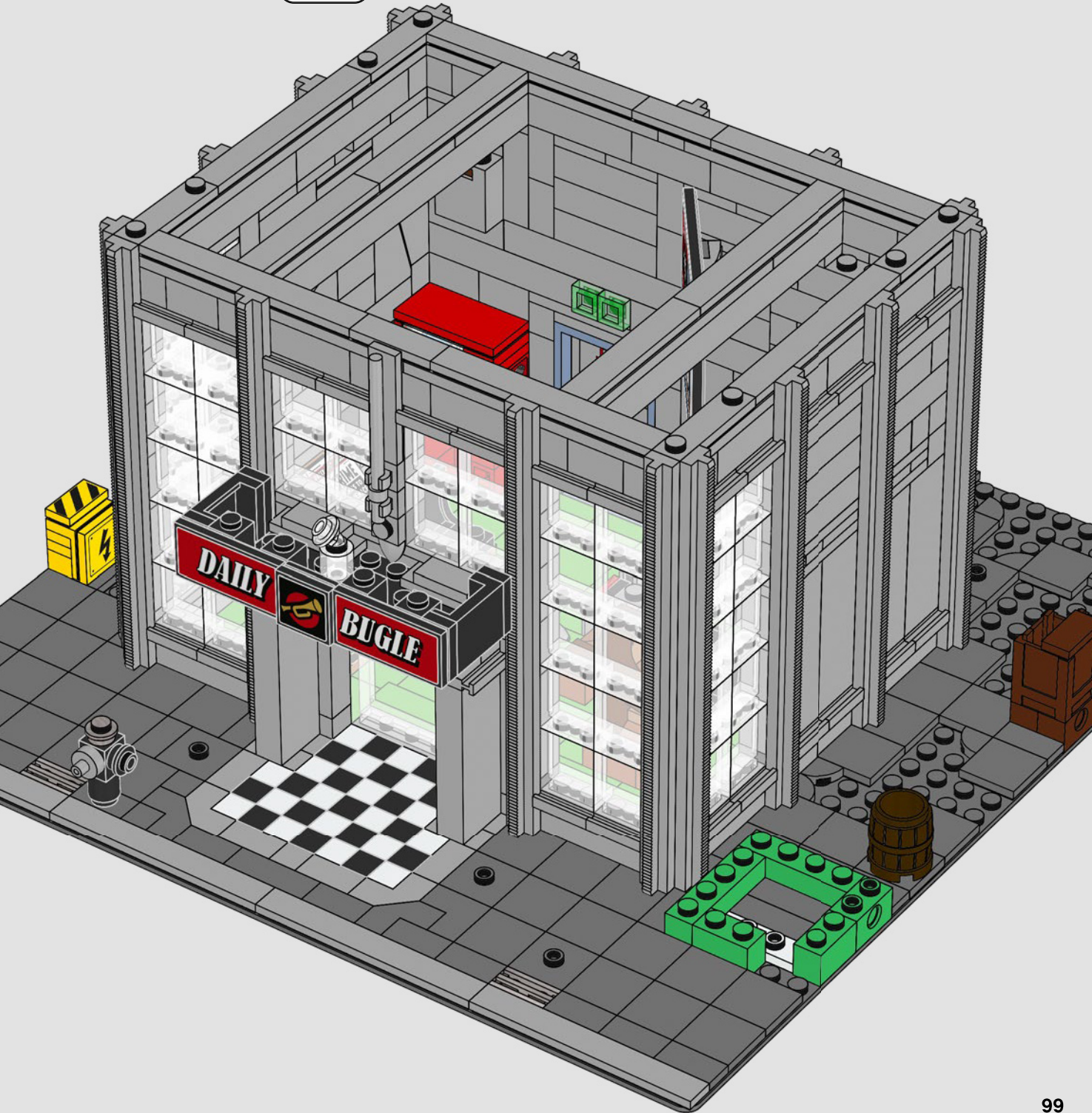



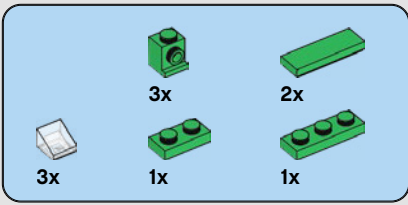

95

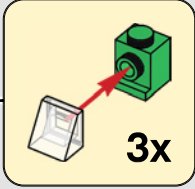
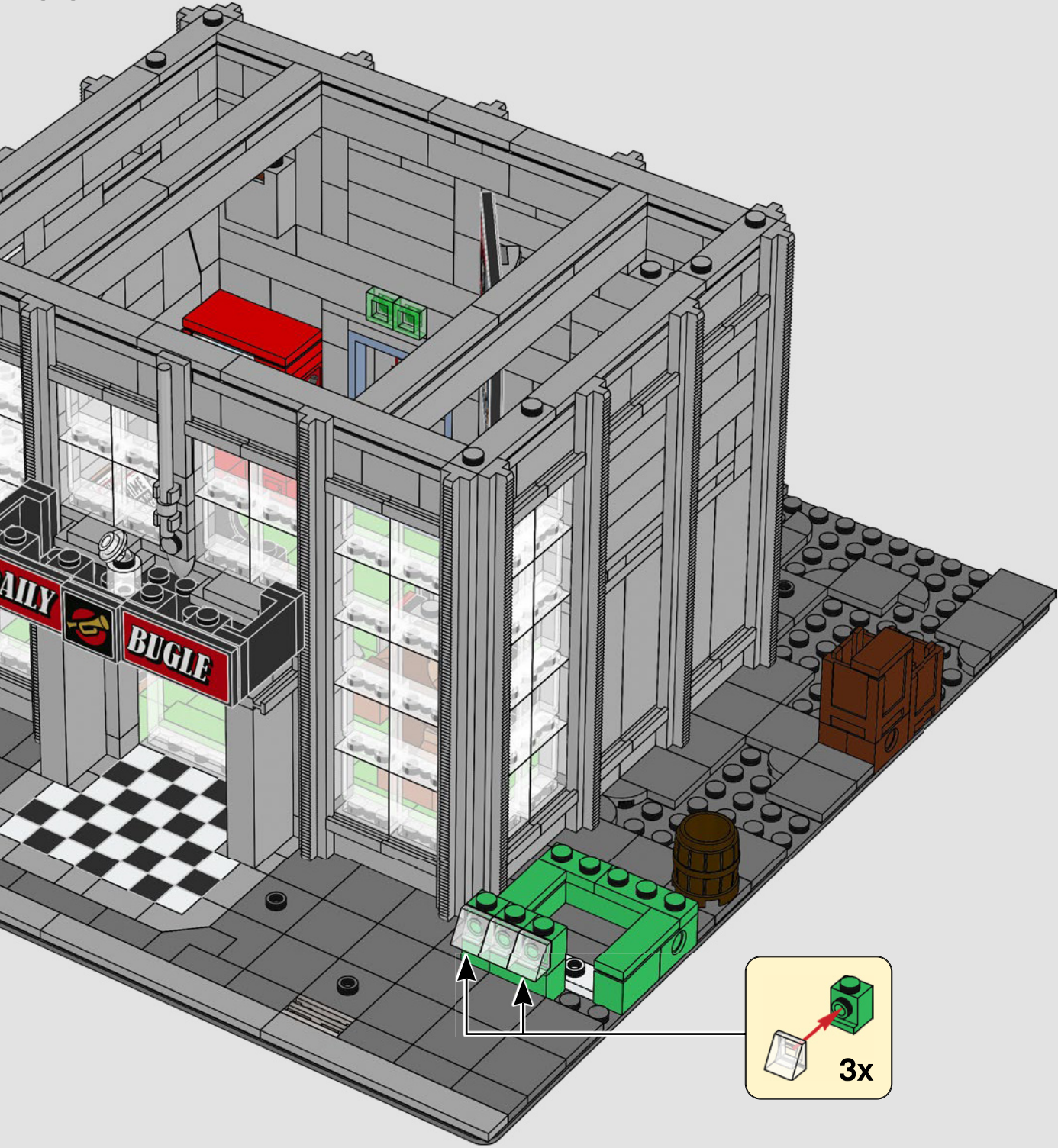

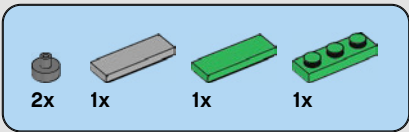

96

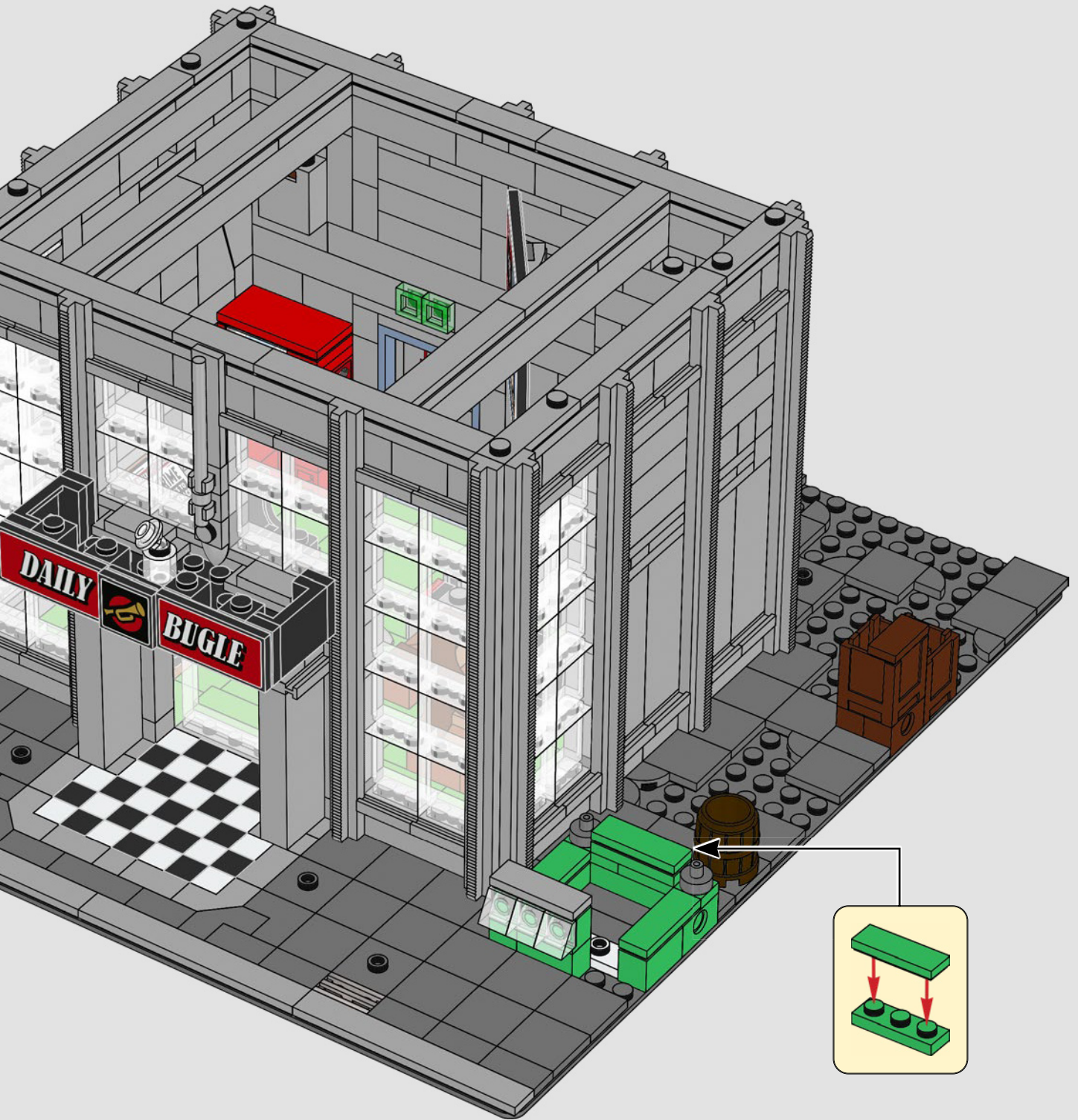



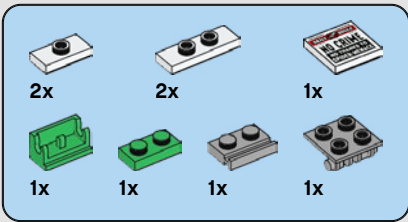

97

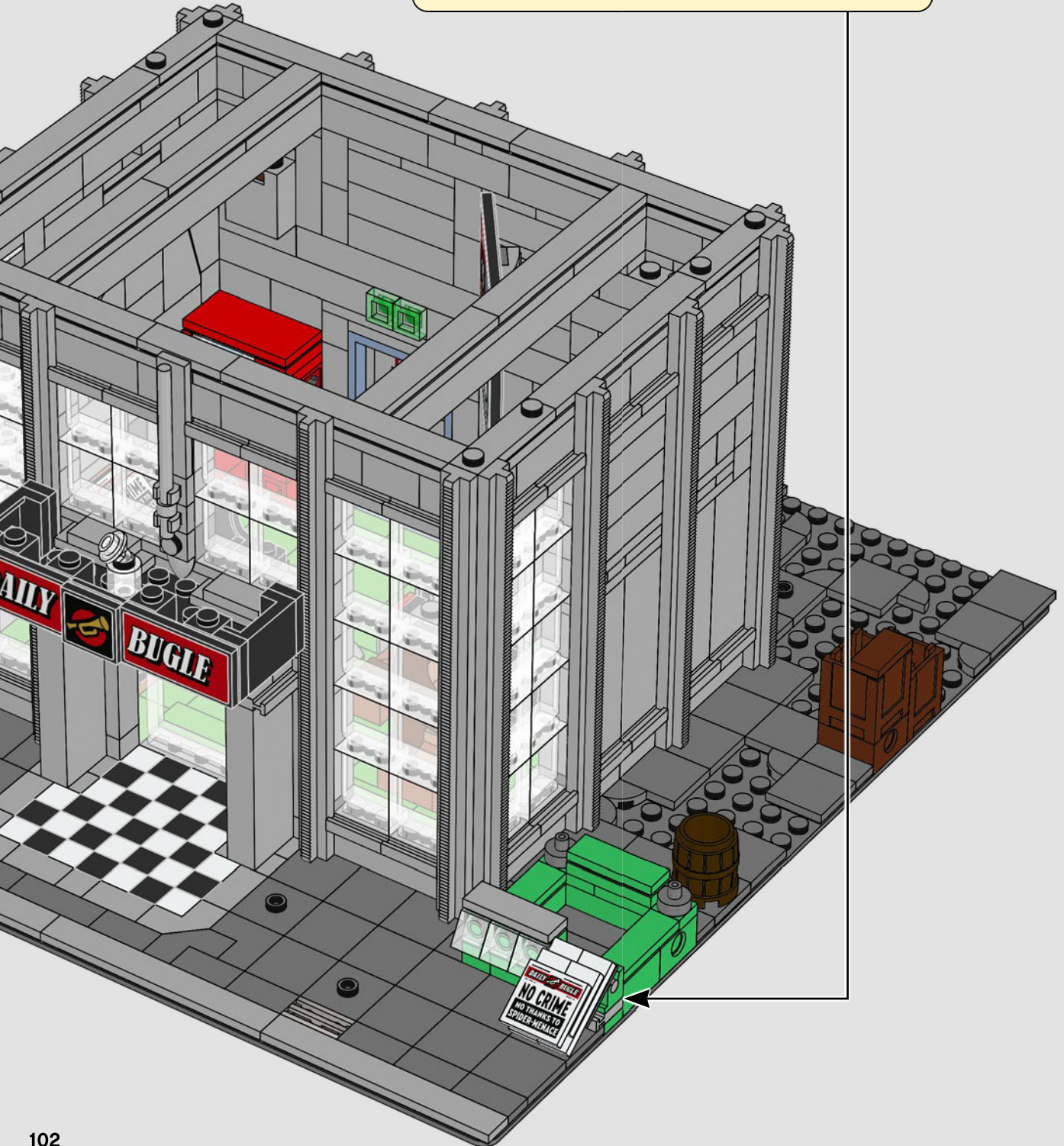
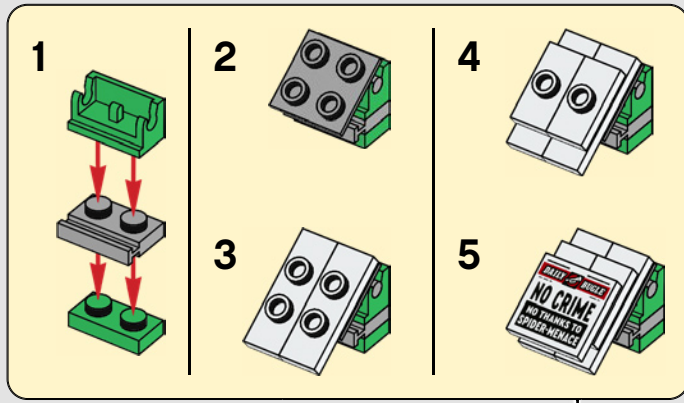

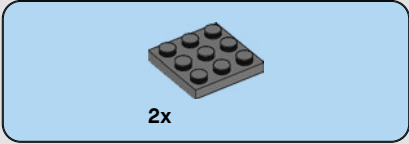
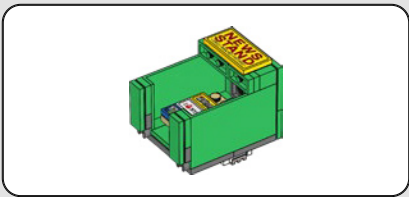

98

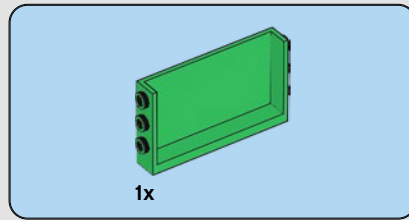
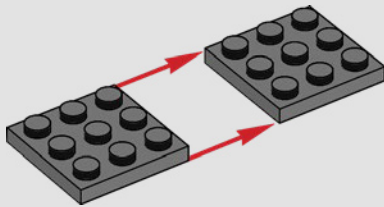

99

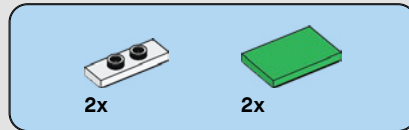
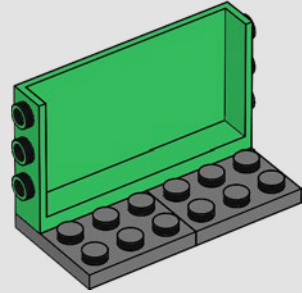

100

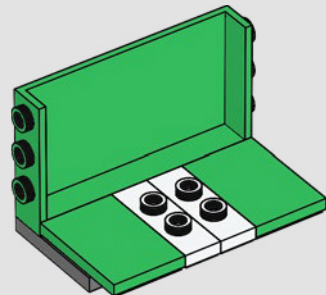



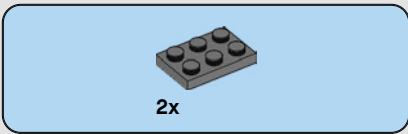

# 101

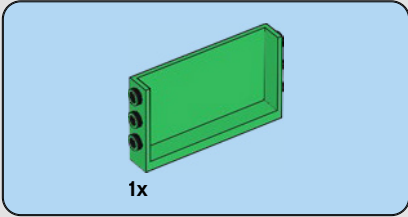
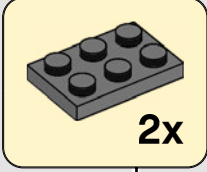
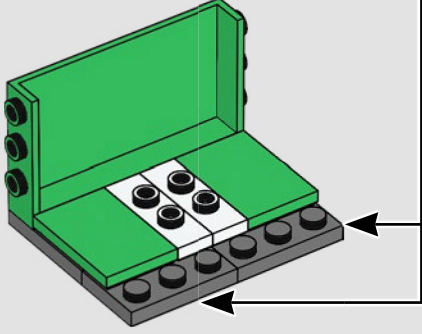

# 102

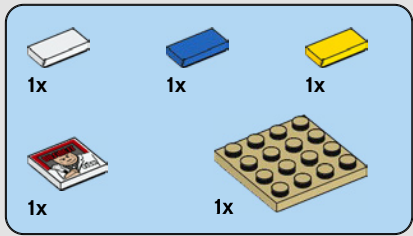
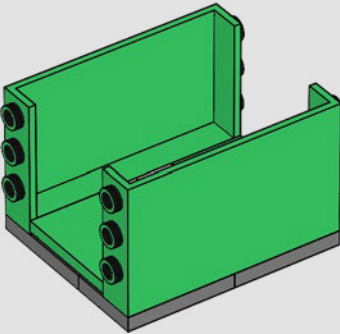

# 103

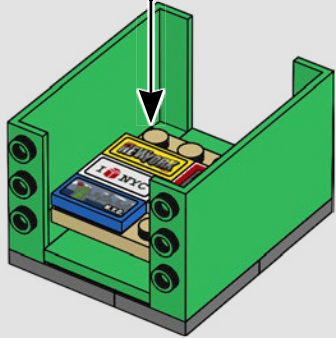
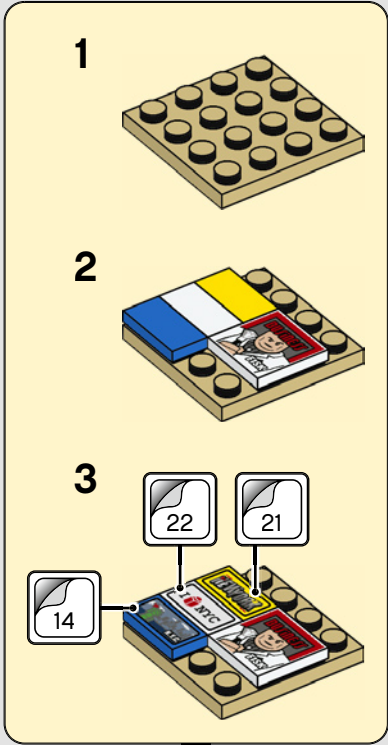

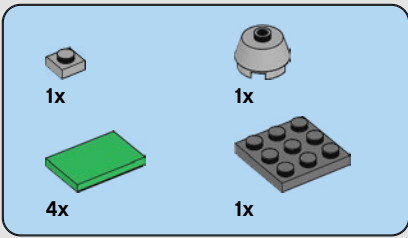

# 104

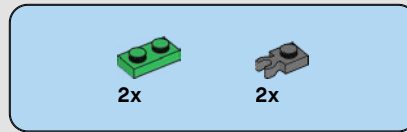
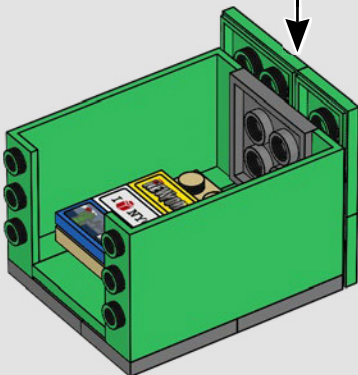
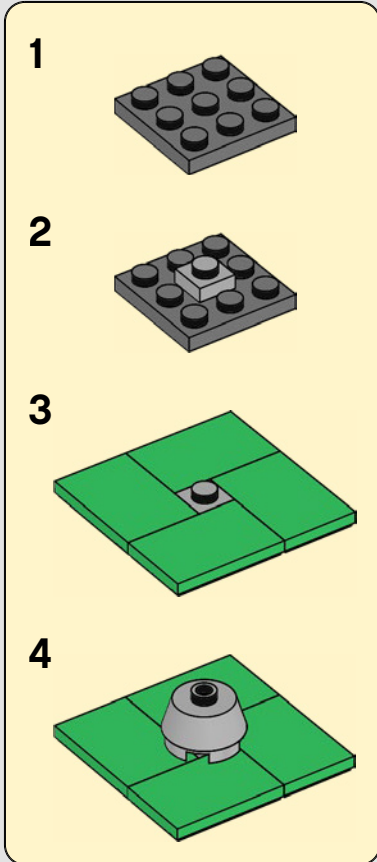

# 105

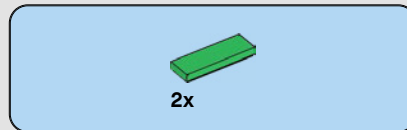
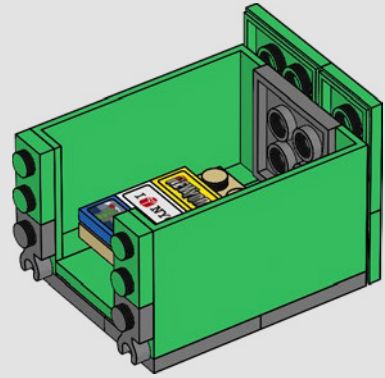

# 106

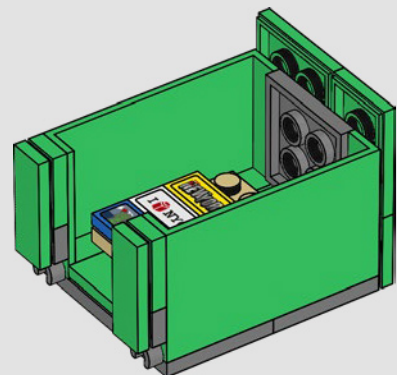



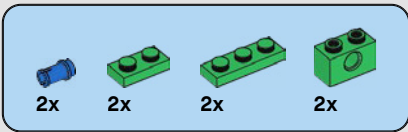

107

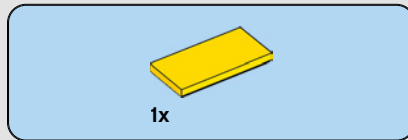
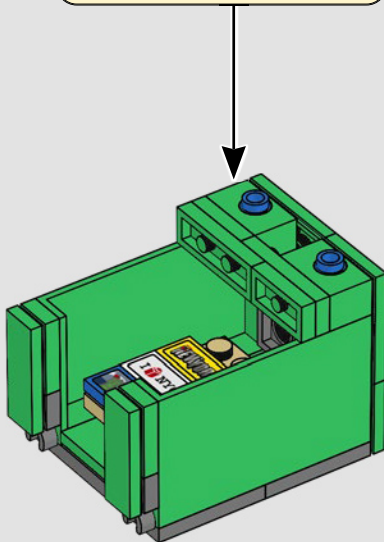
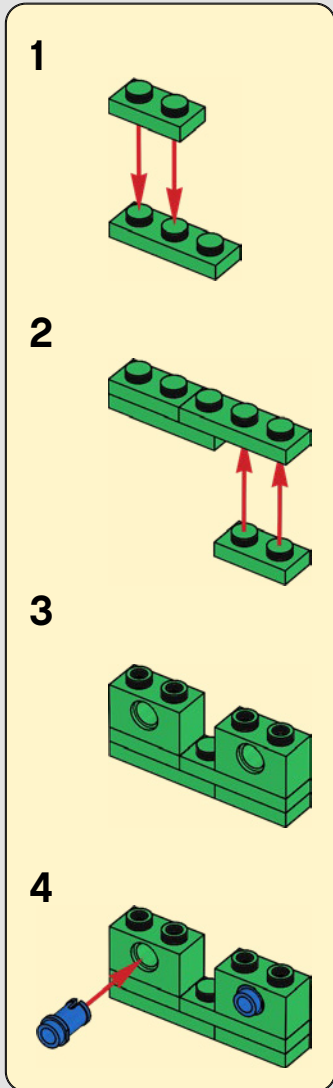

108

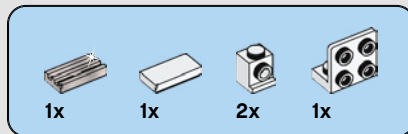
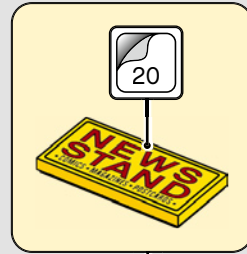

109

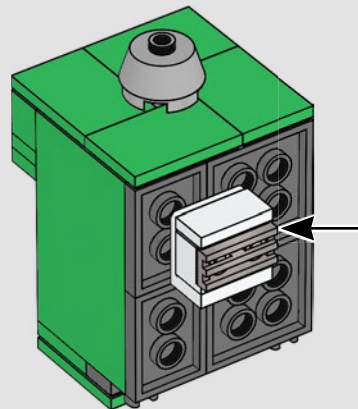
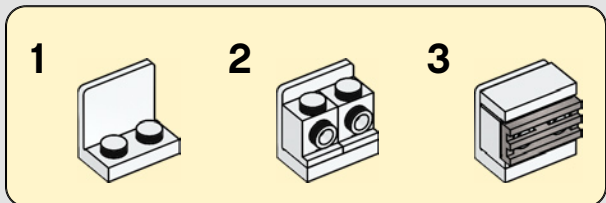

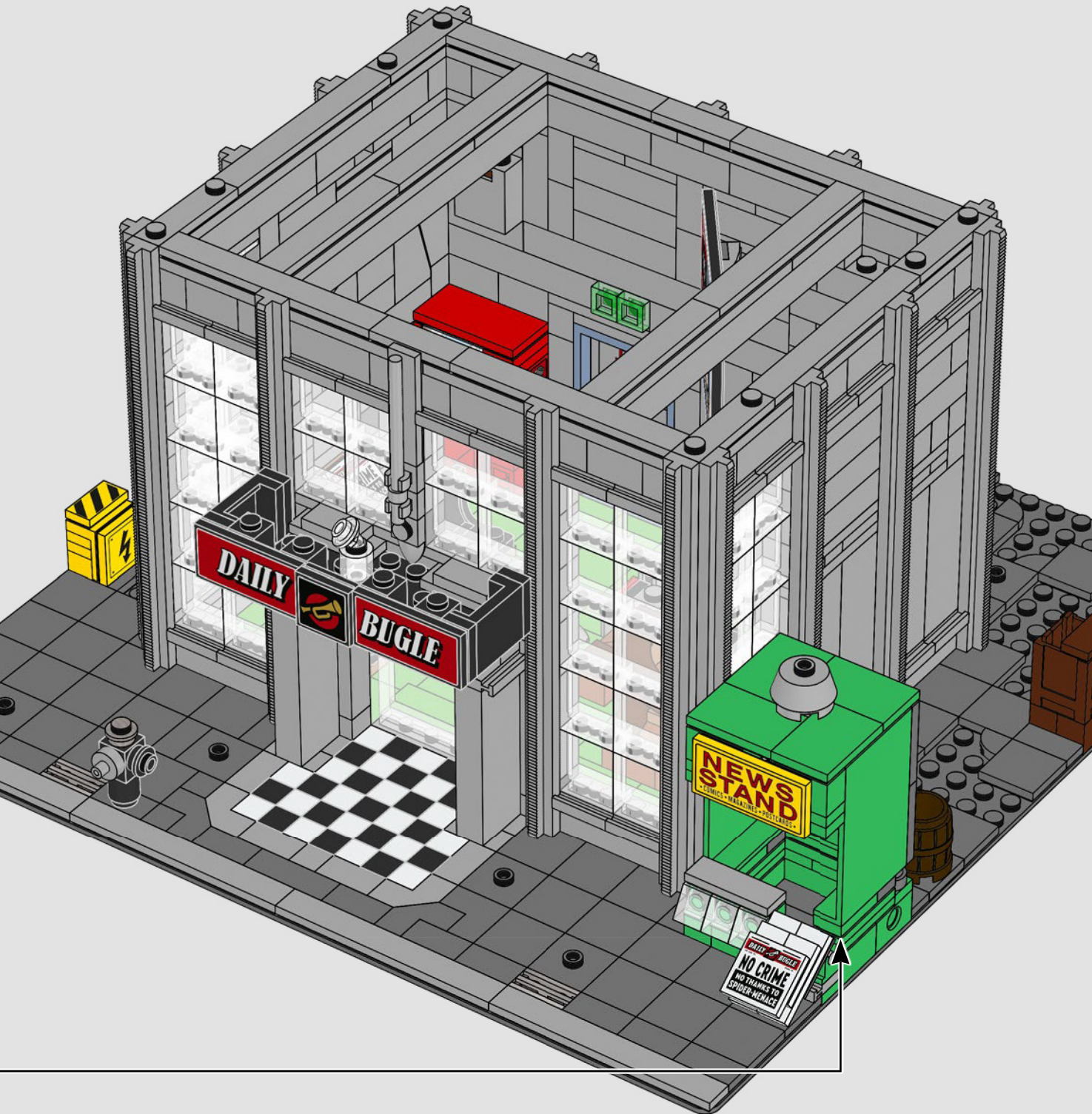



- 4x
- 4x
- 2x
- 12x
- 2x
- 2x

111

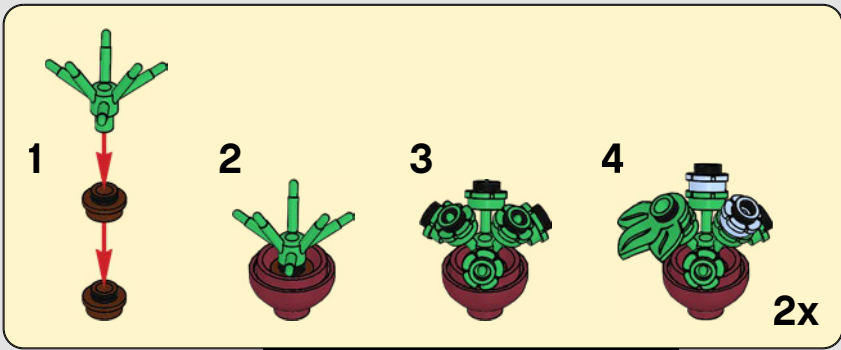

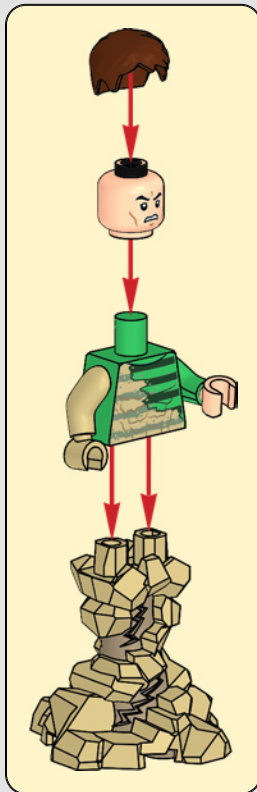
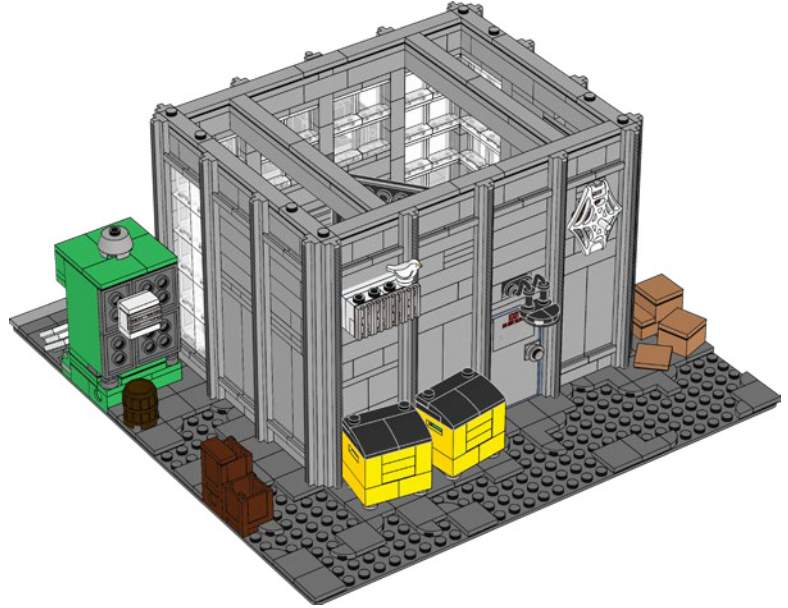
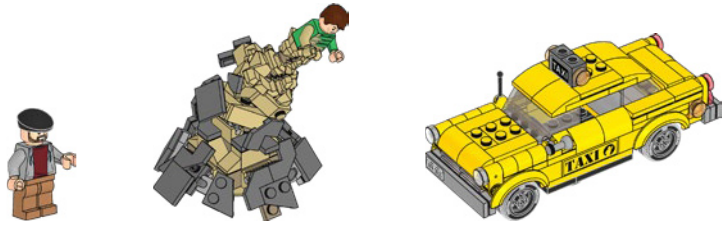



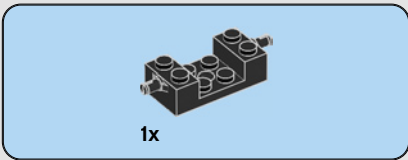
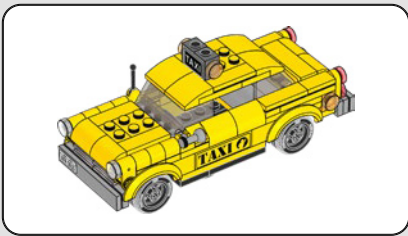

1x

112

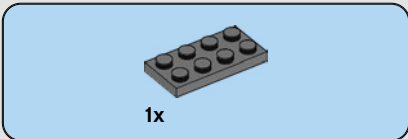
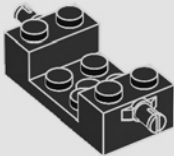

1x

113

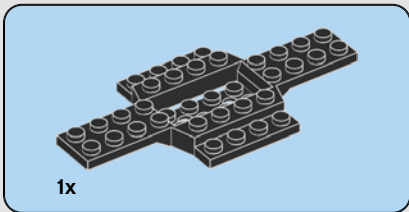
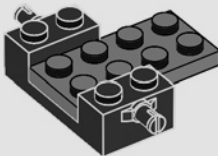

1x

114

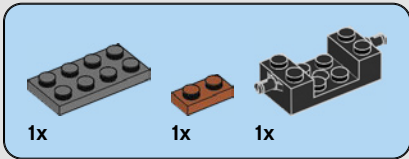
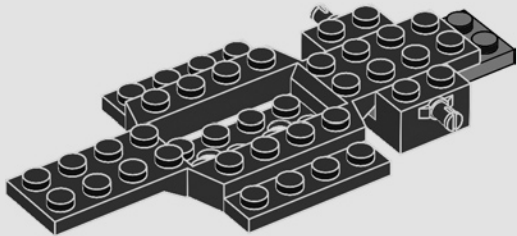

1x

1x

1x

115

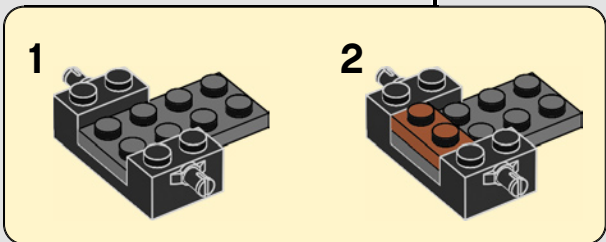
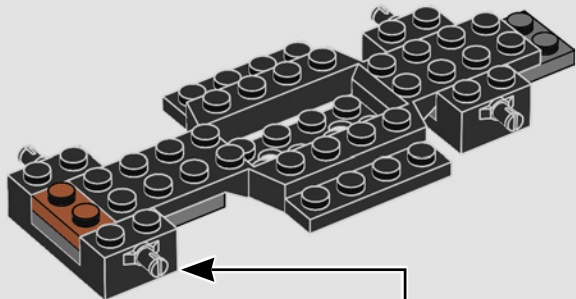

1

2



2x

# 116

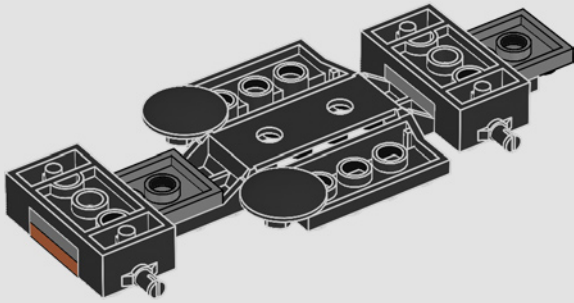

2x



2x



2x

# 117

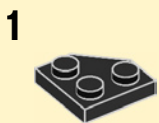
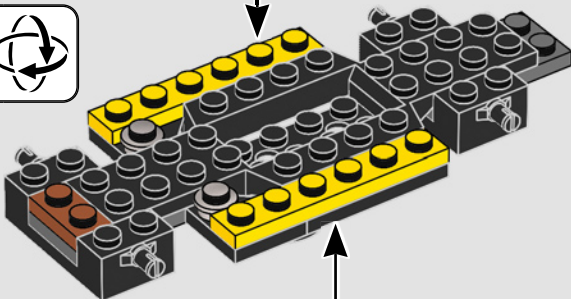
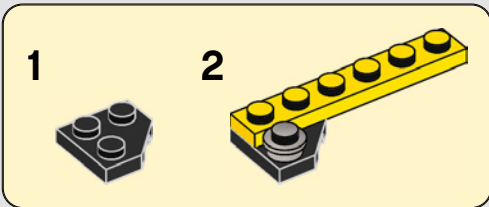

1

2



1x



1x

# 118

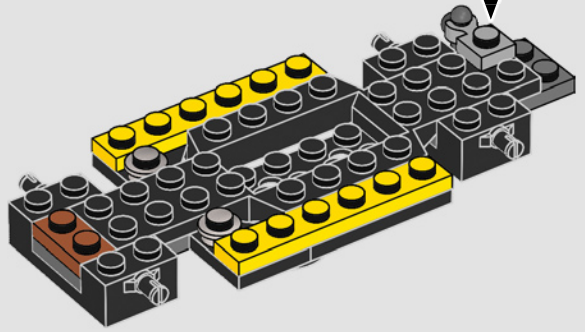
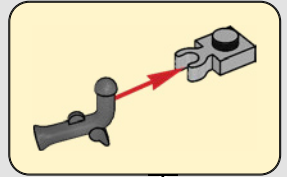

2x



1x



1x

# 119

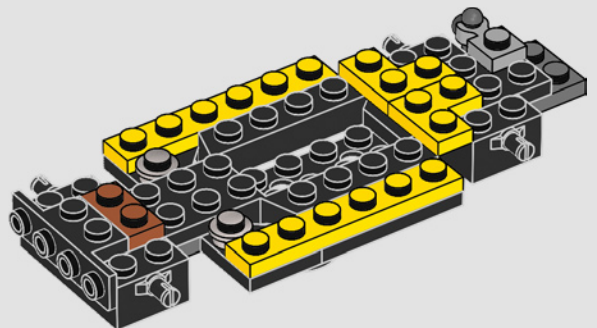



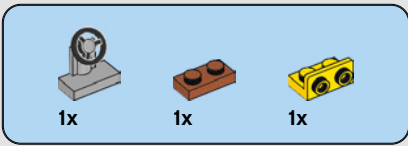

120

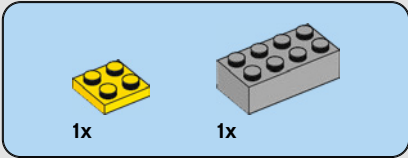
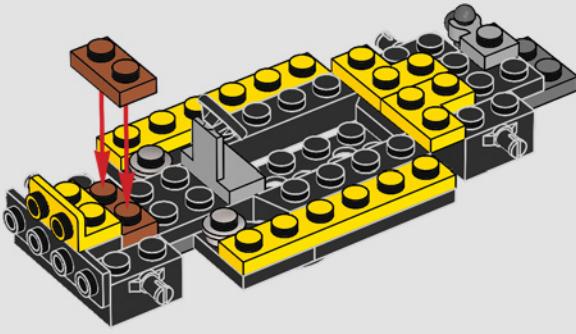

121

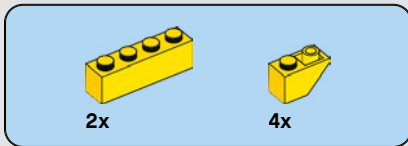
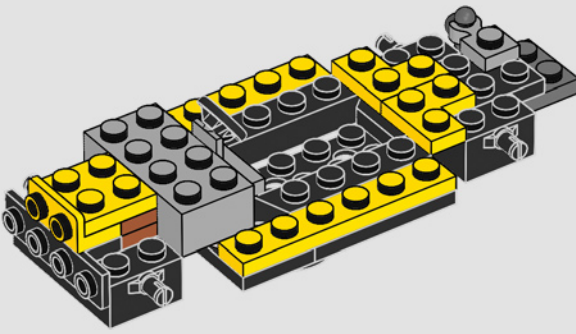

122

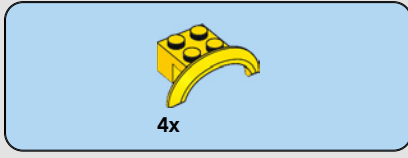
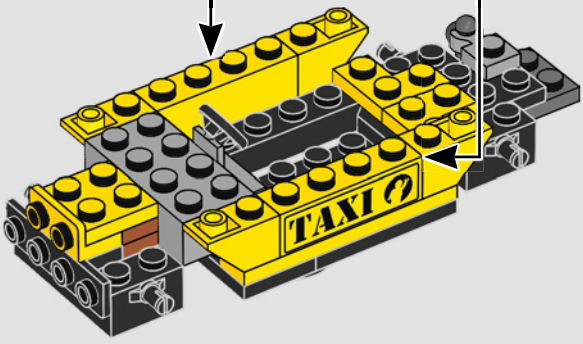

123

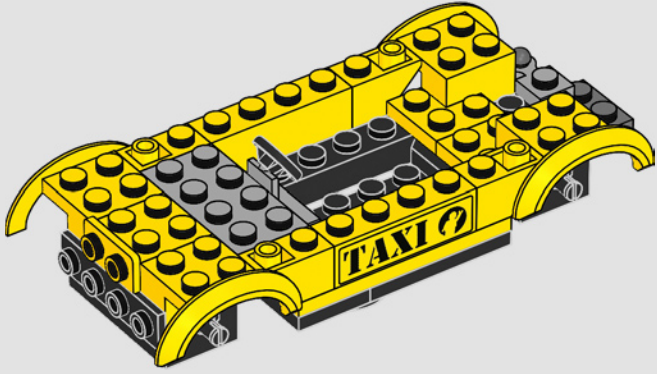

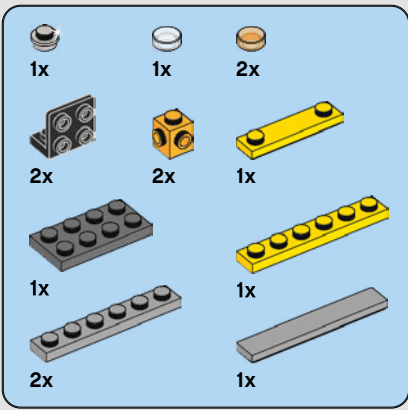

# 124

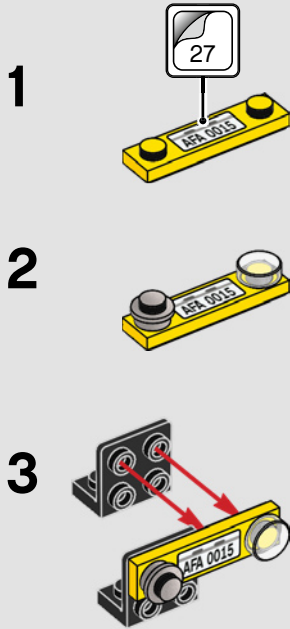

4

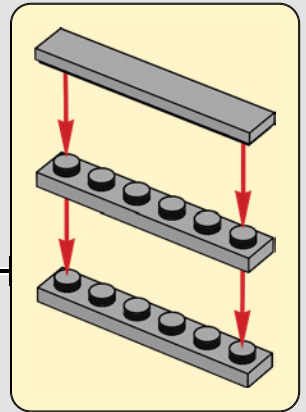
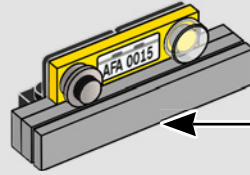

5

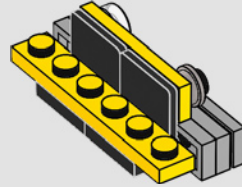

6

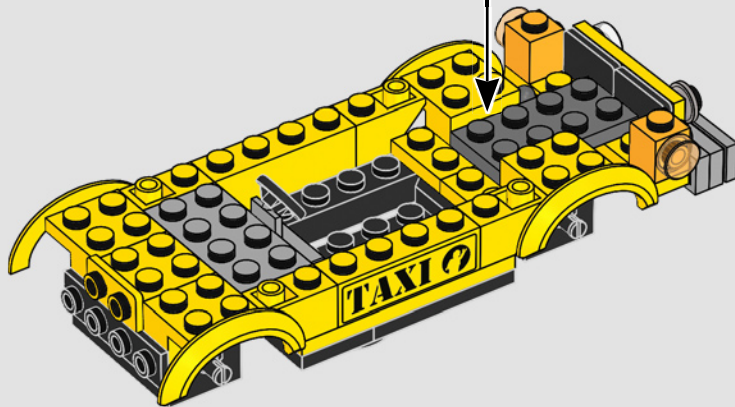
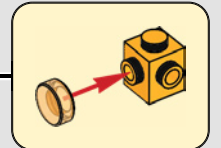
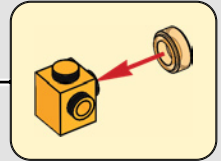
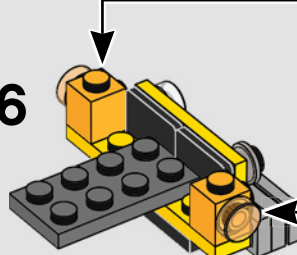



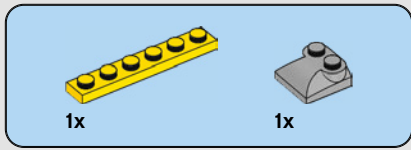

125

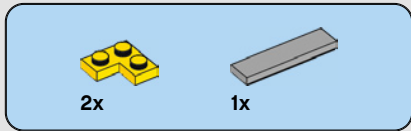
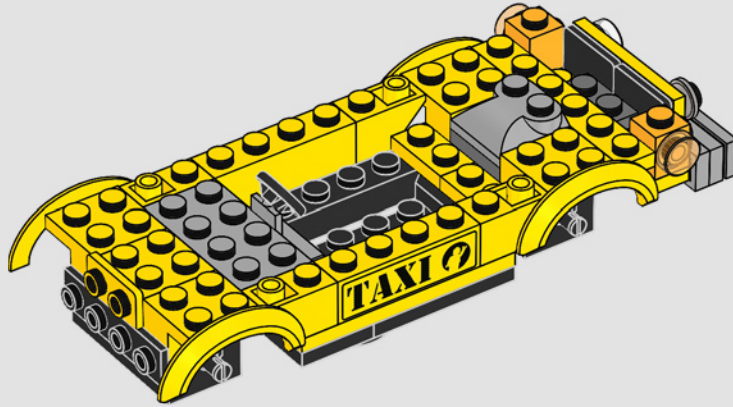

126

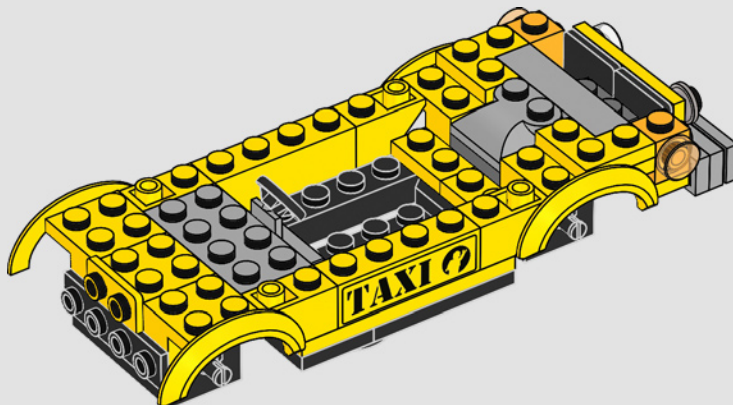

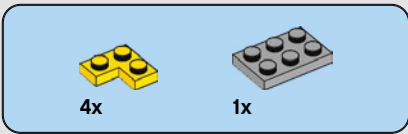

127

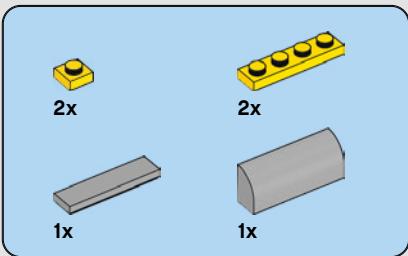
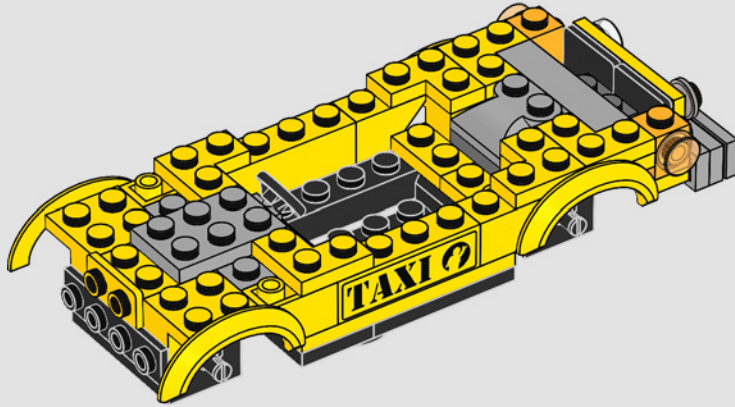

128

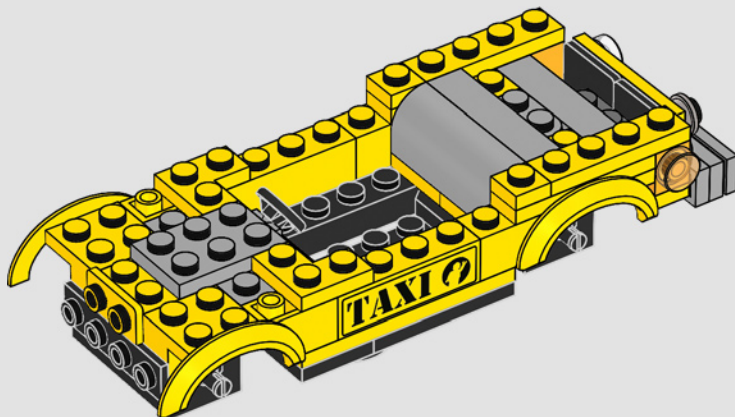



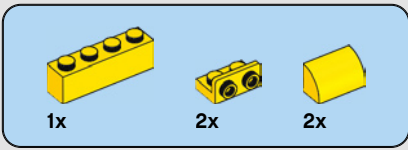

129

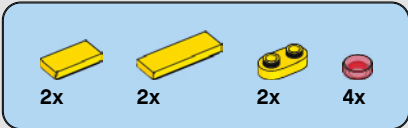
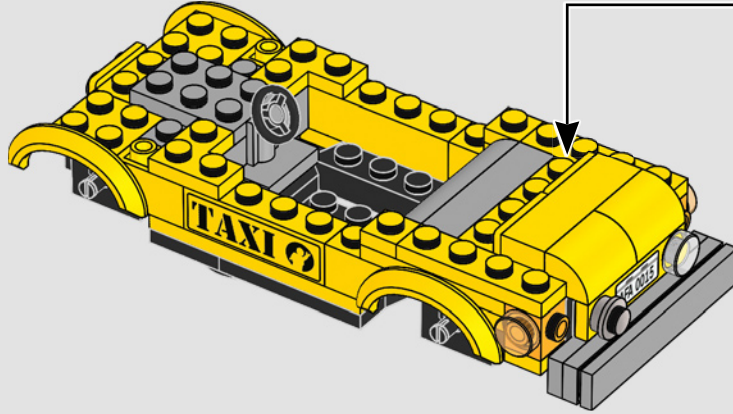
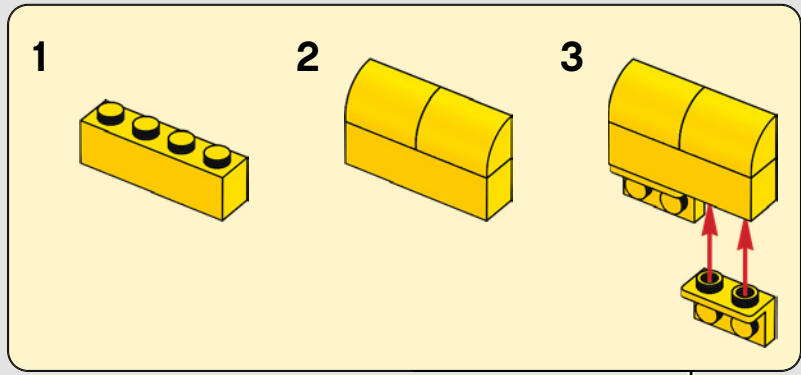

130

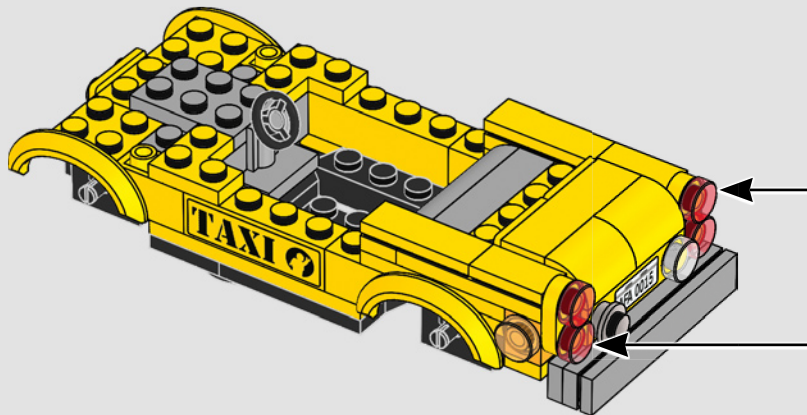
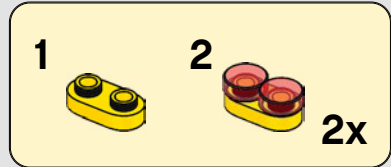

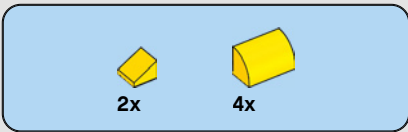

131

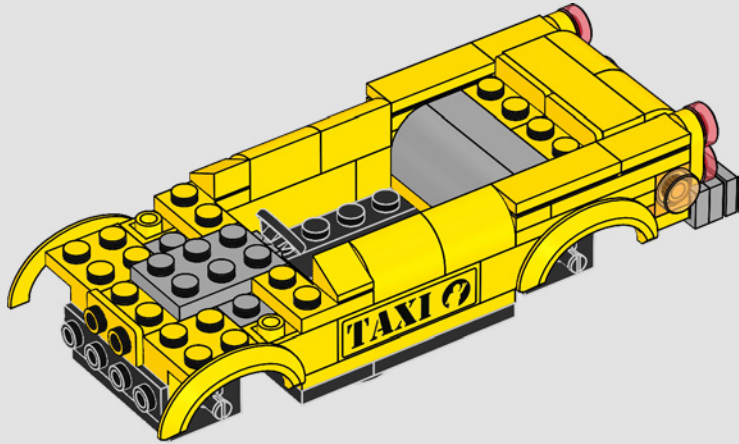

132

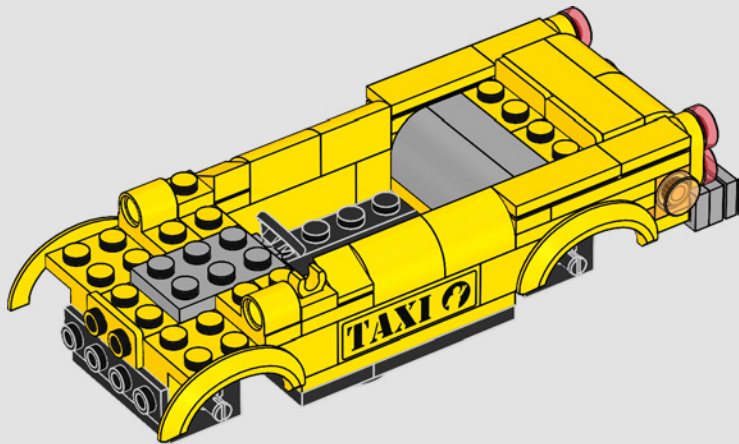





# 133

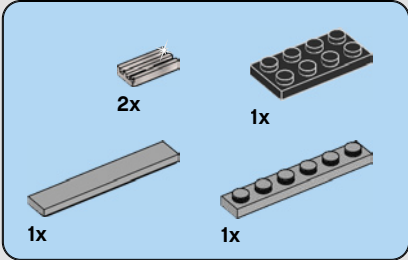
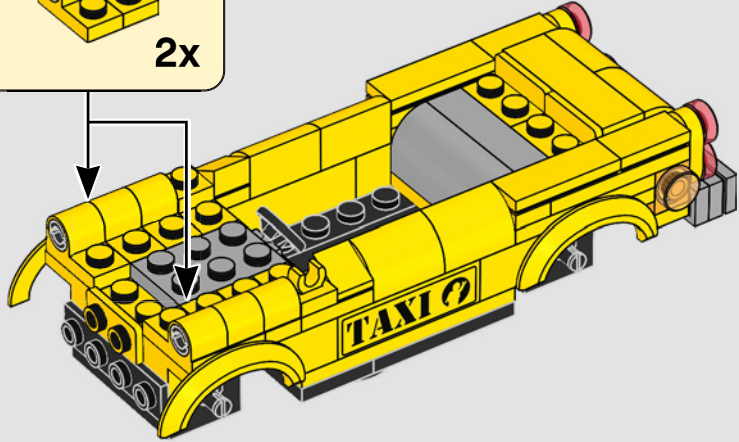
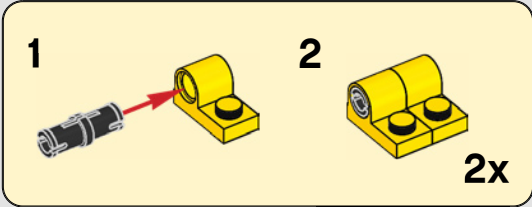

# 134

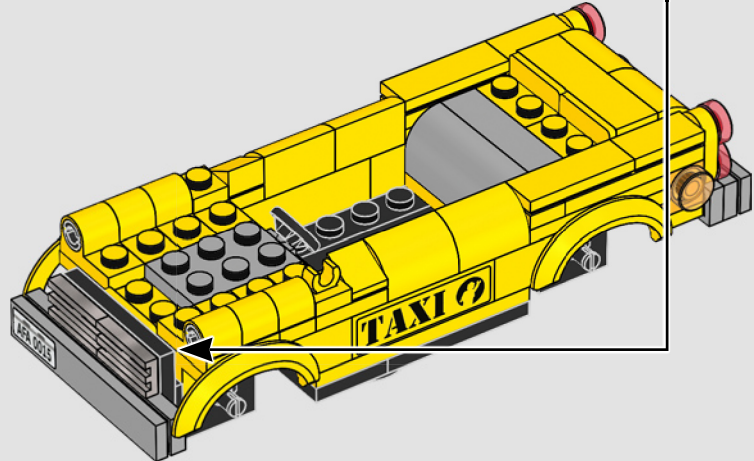
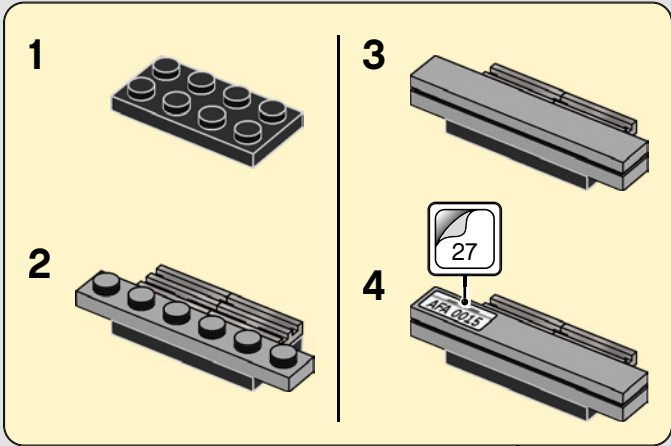



# 135

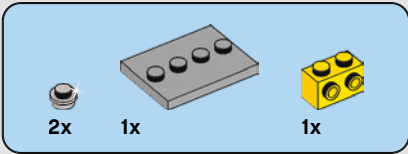
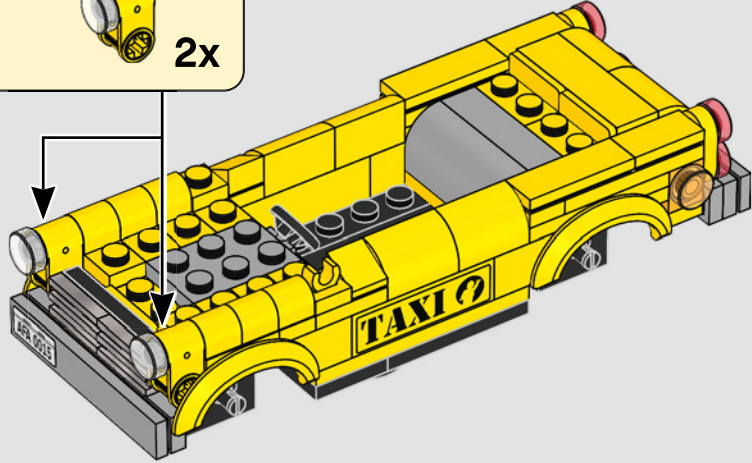
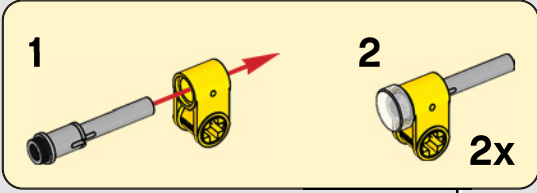

# 136

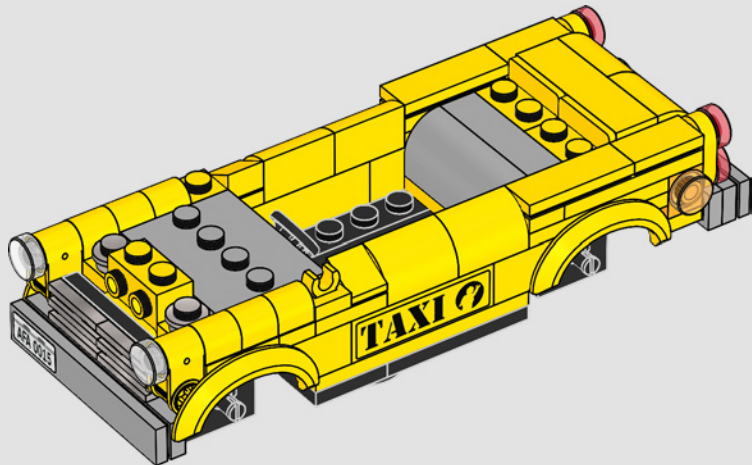



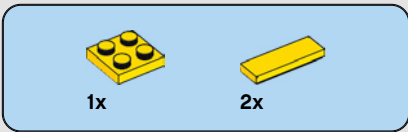

# 137

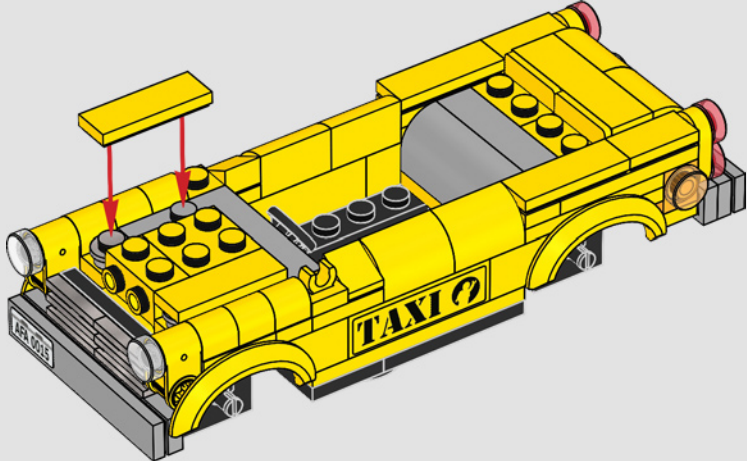

# 138

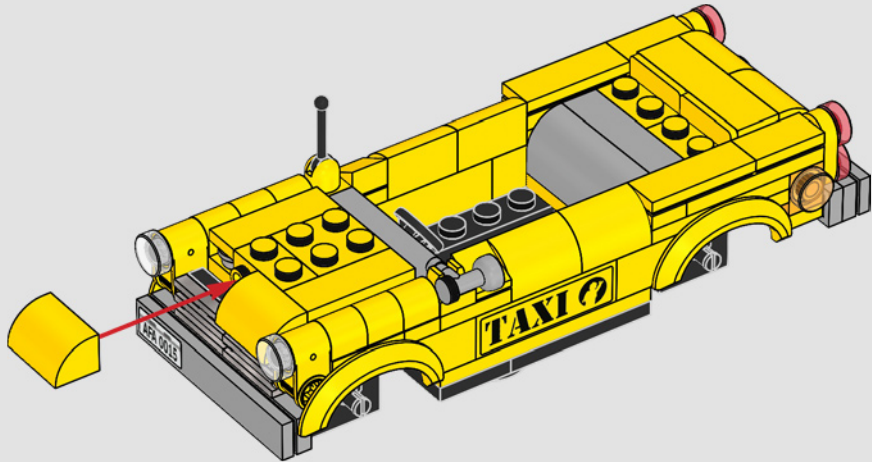

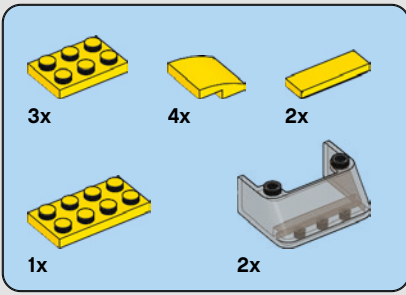

139

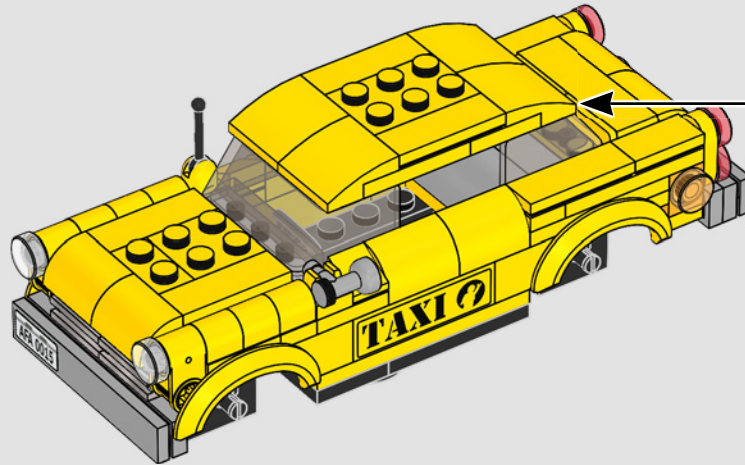
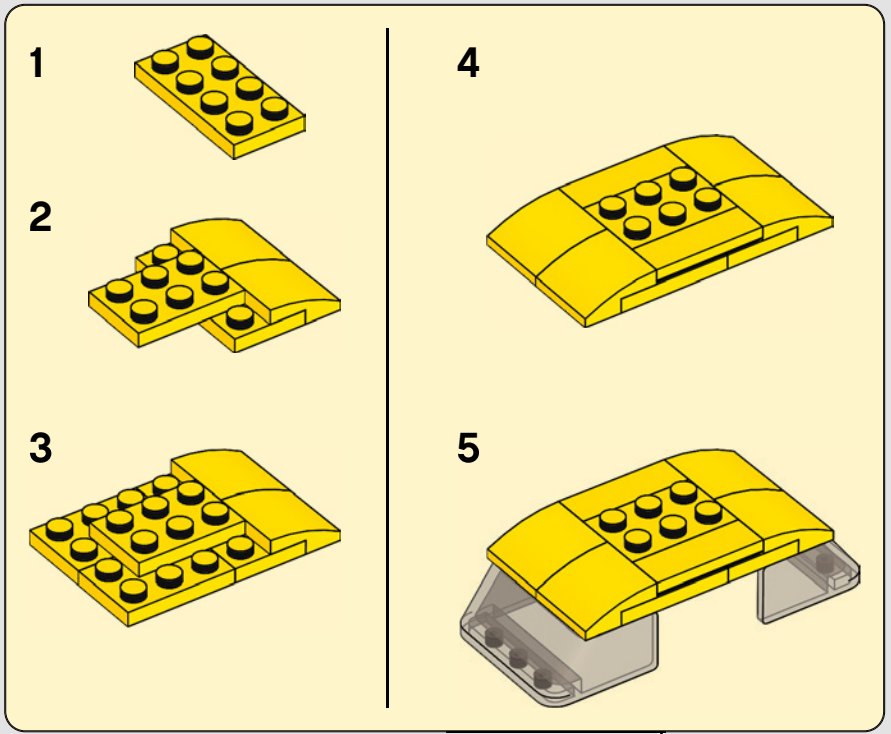



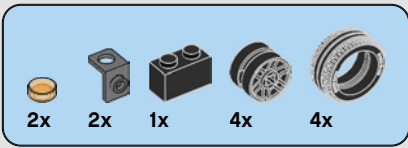

# 140

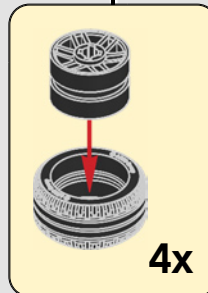
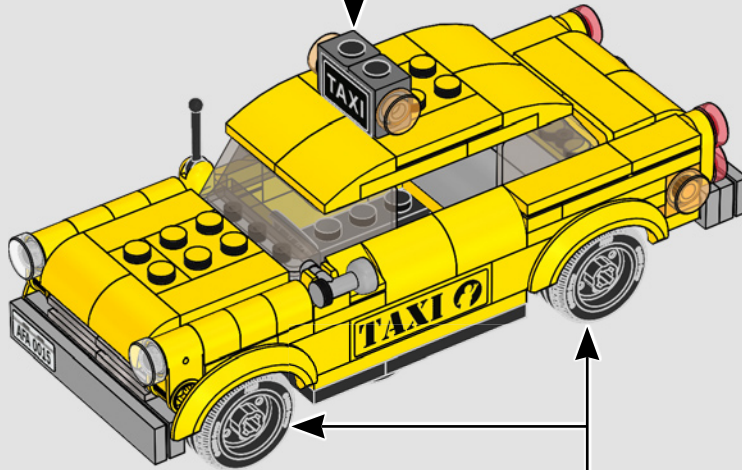
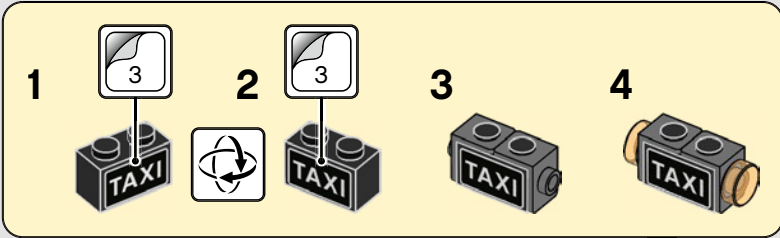

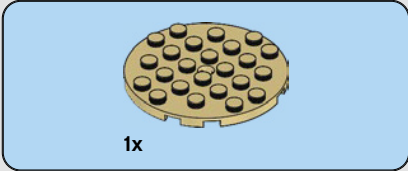
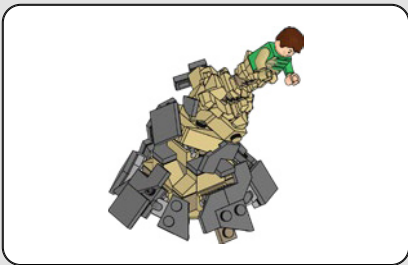

141

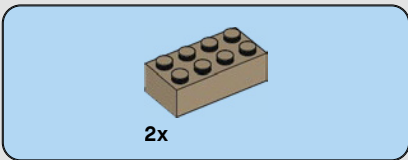
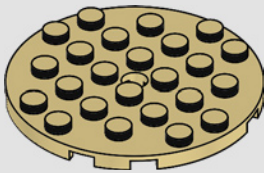

142

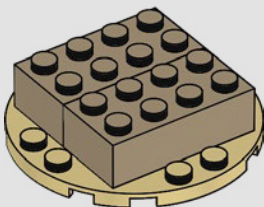

143

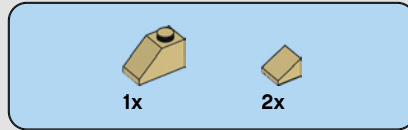
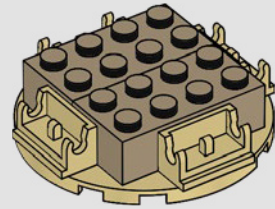

144

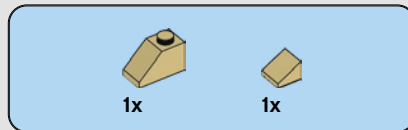
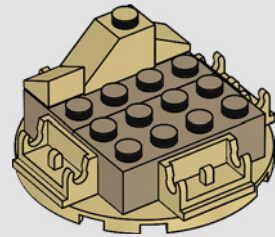

145

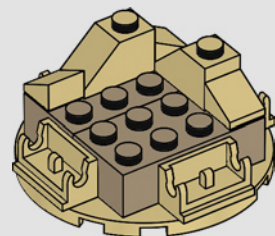



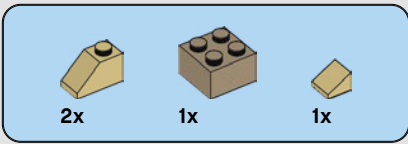

146

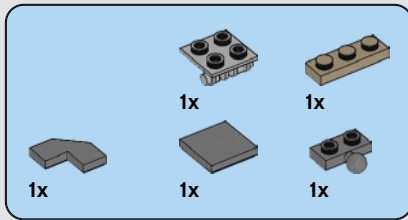
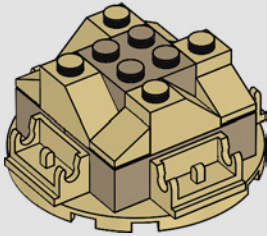

148

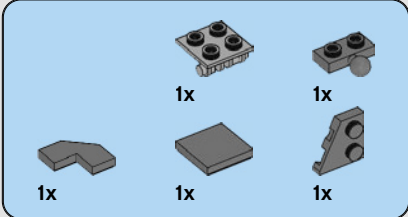
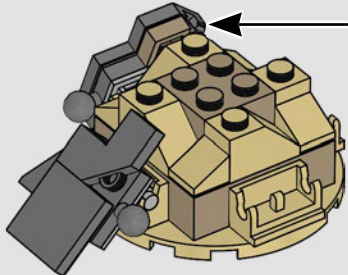
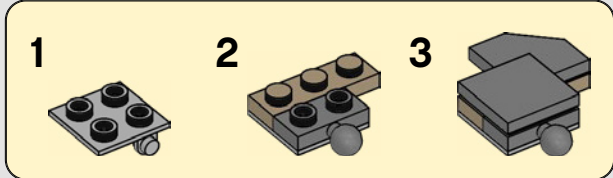

147

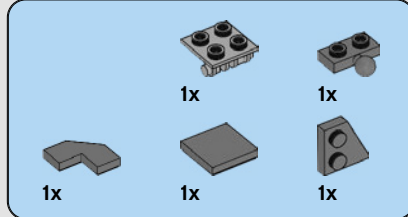
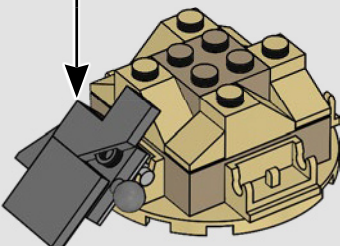
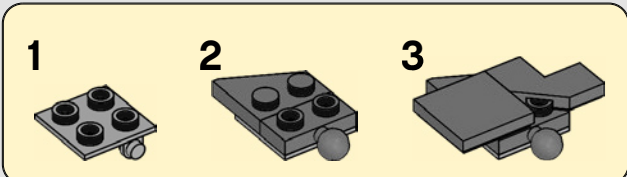

149

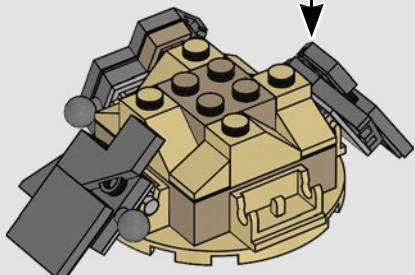
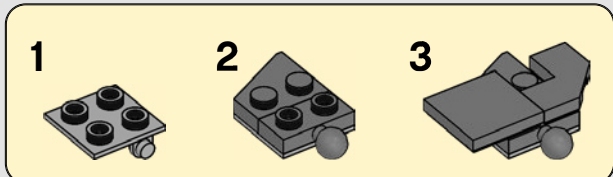

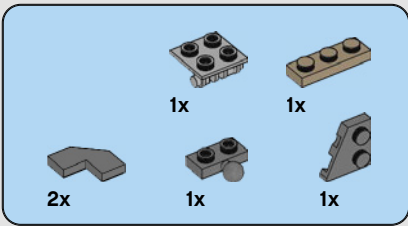

# 150

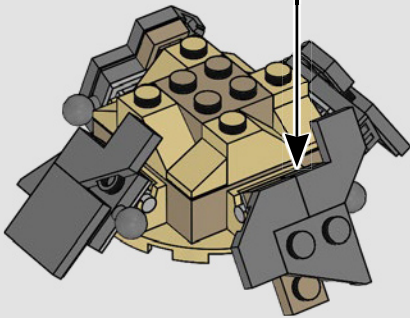
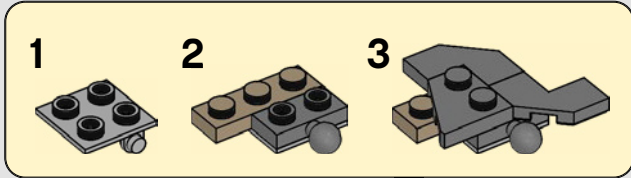

# 151

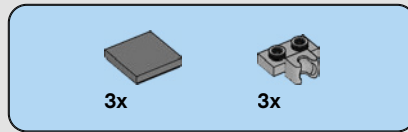
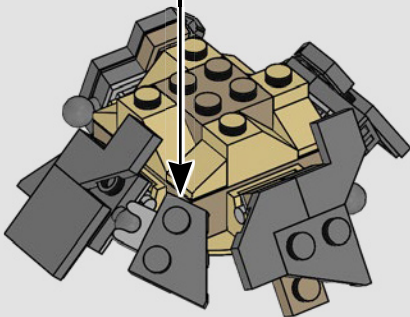
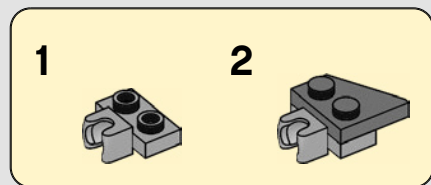

# 152

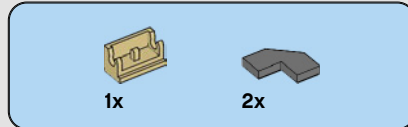
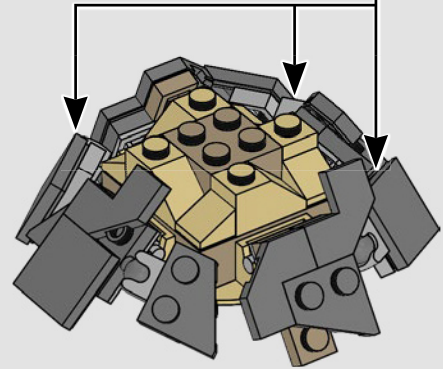
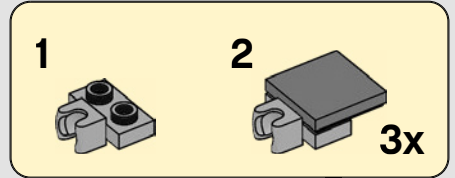

# 153

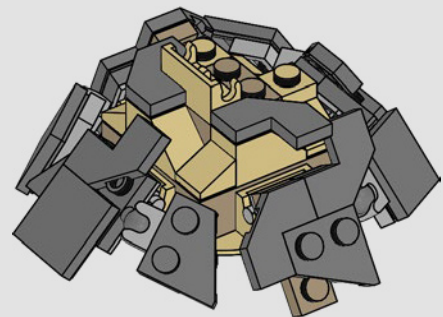



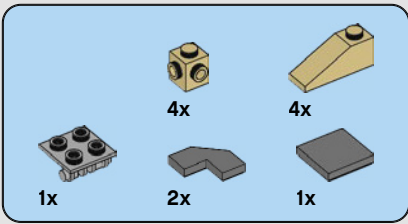

154

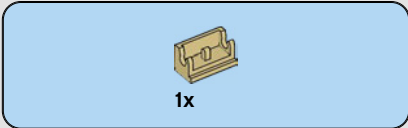
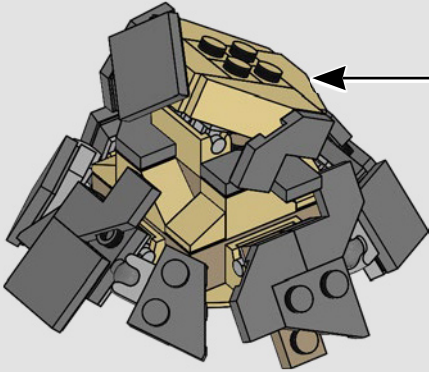
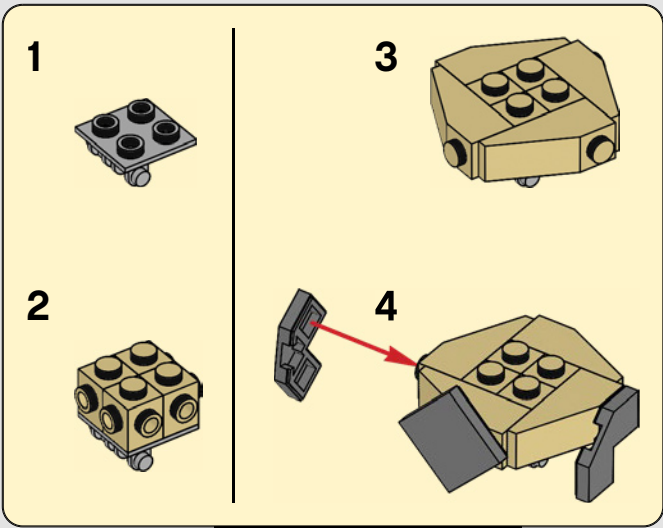

155

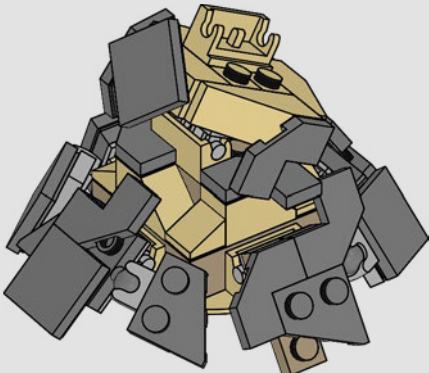

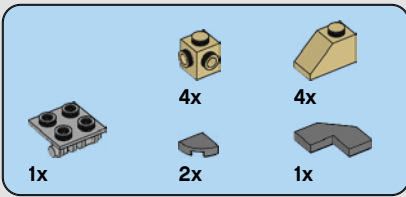

156

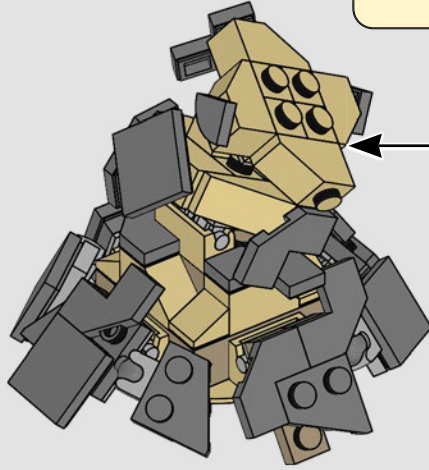
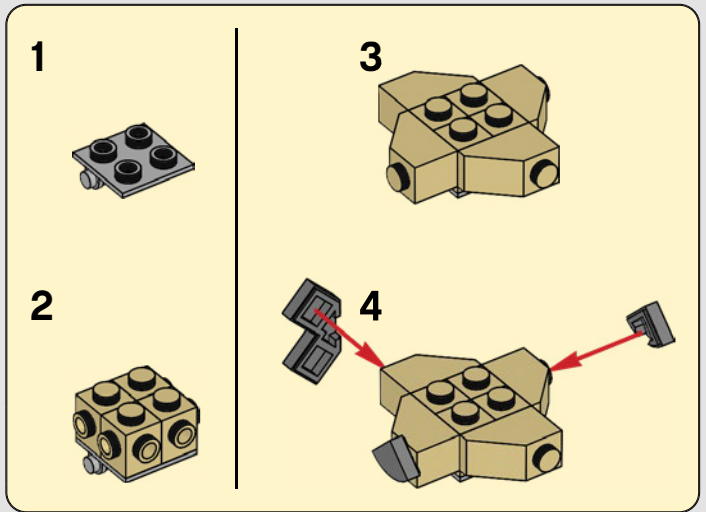

157

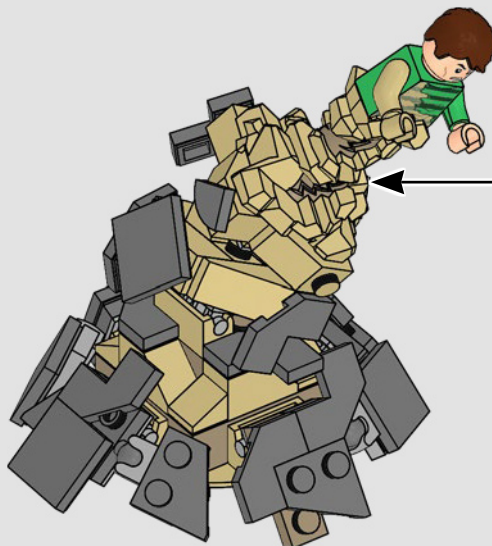





2x

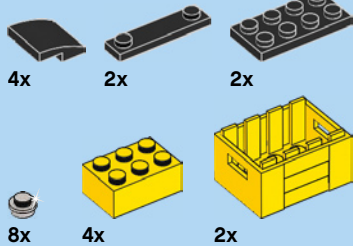

158

1

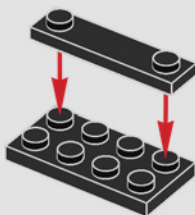

2

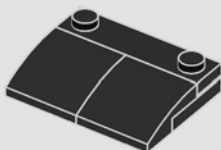

3

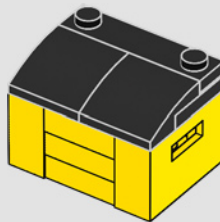

4

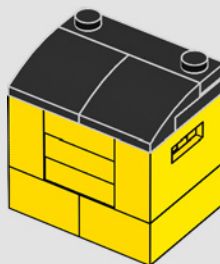

5

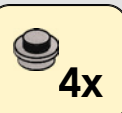
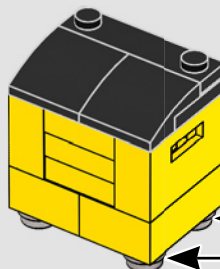

2x

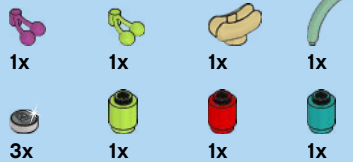

159

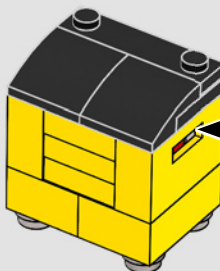
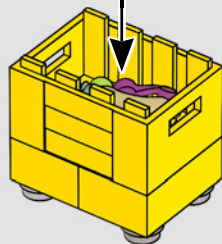
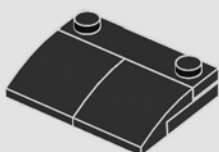
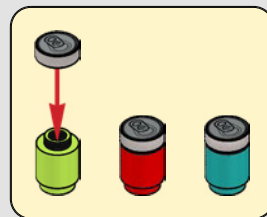
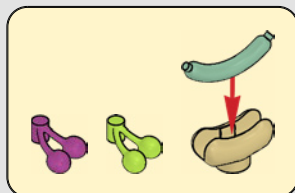

160

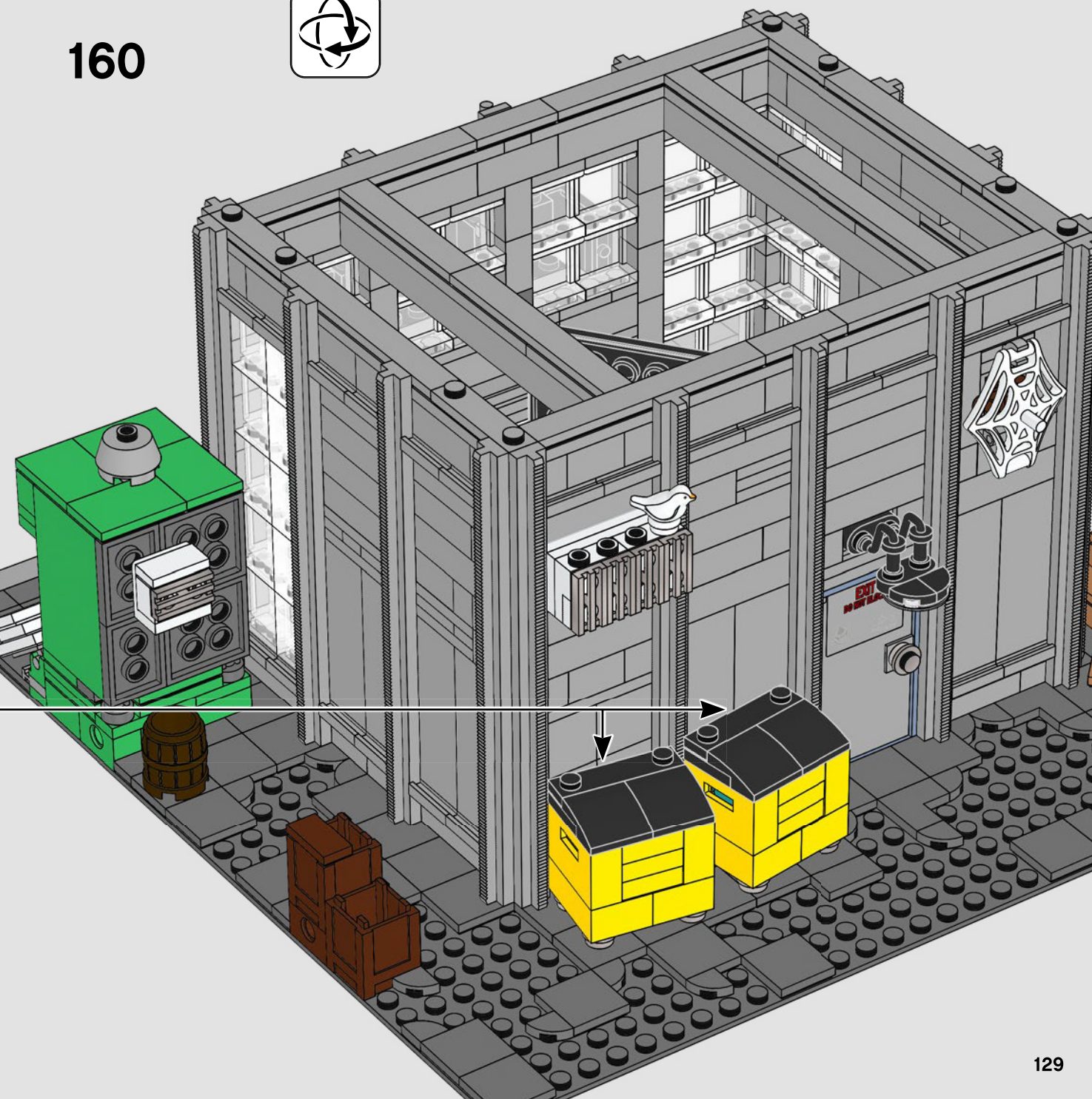



1x 1x 1x   
 1x 1x   
 1x 1x   
 1x 1x   
 3x

6

→

→

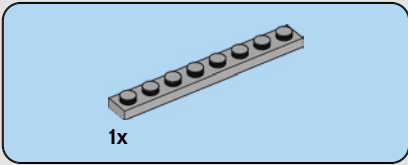
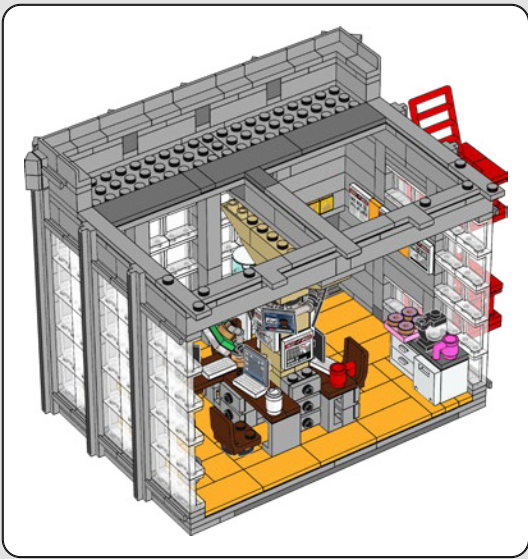

**161**

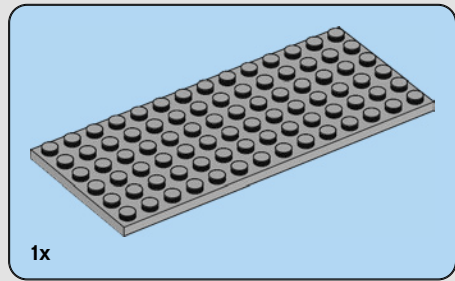
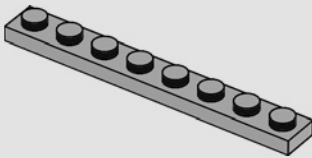

**162**

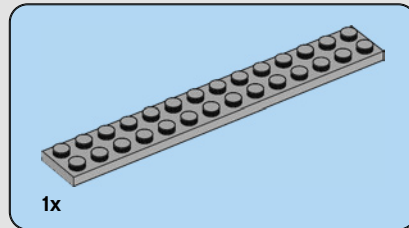
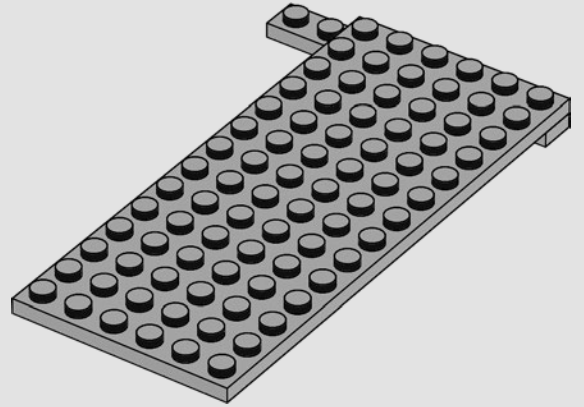

**163**

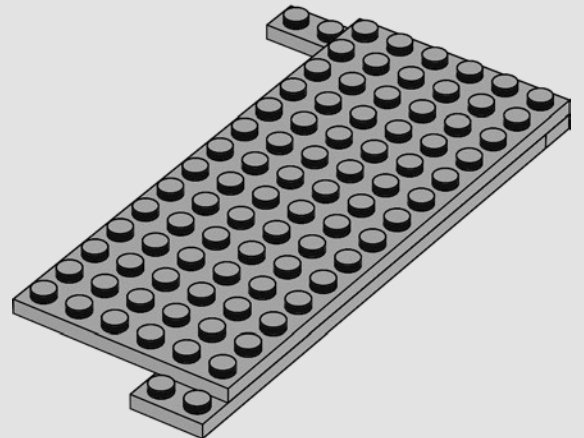



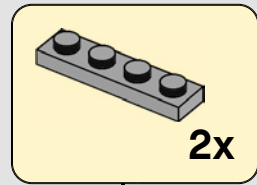
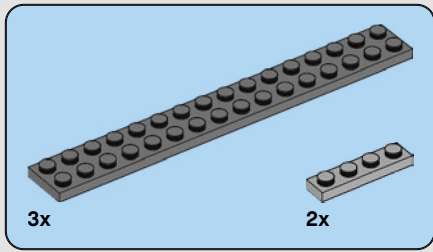

164

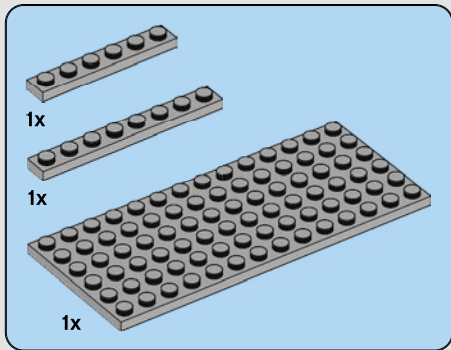
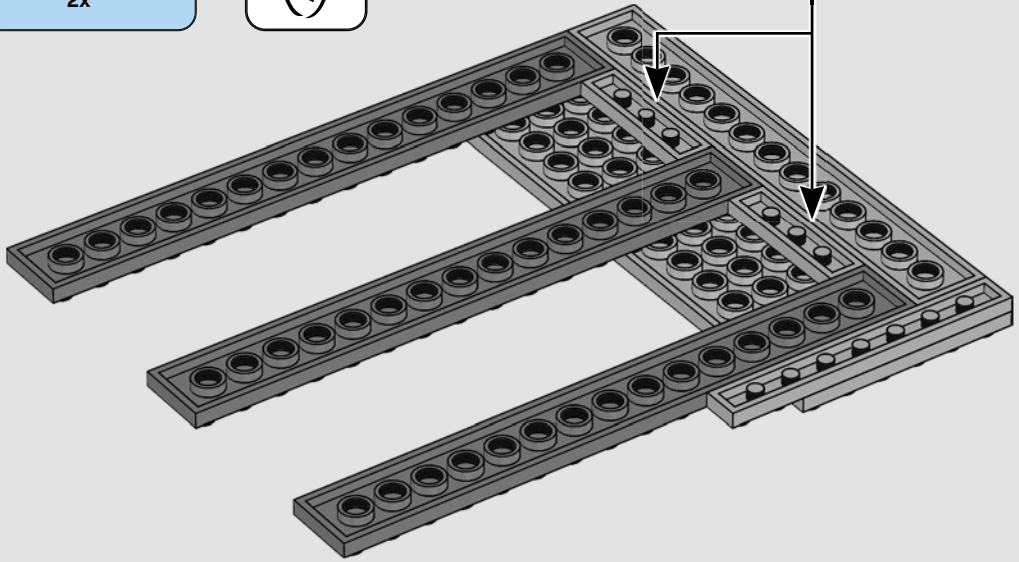

165

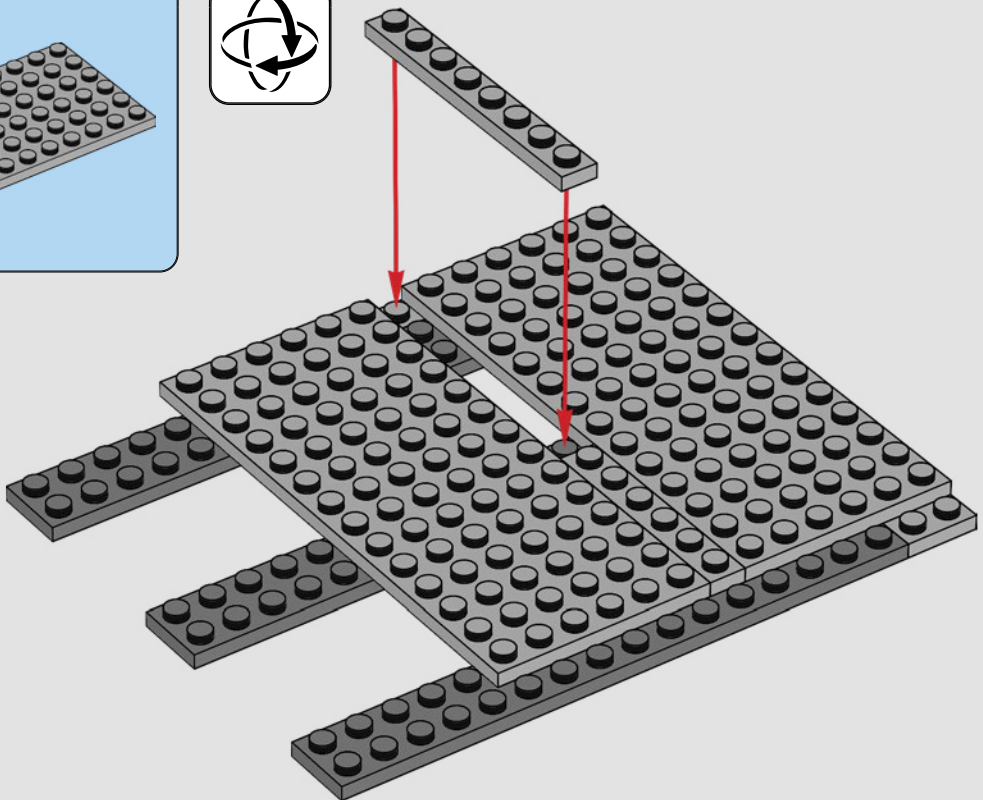

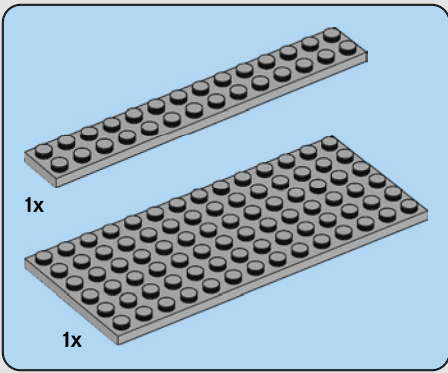

**166**

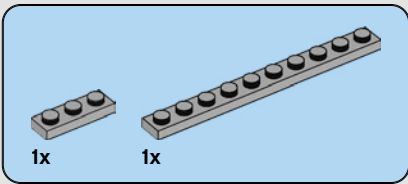
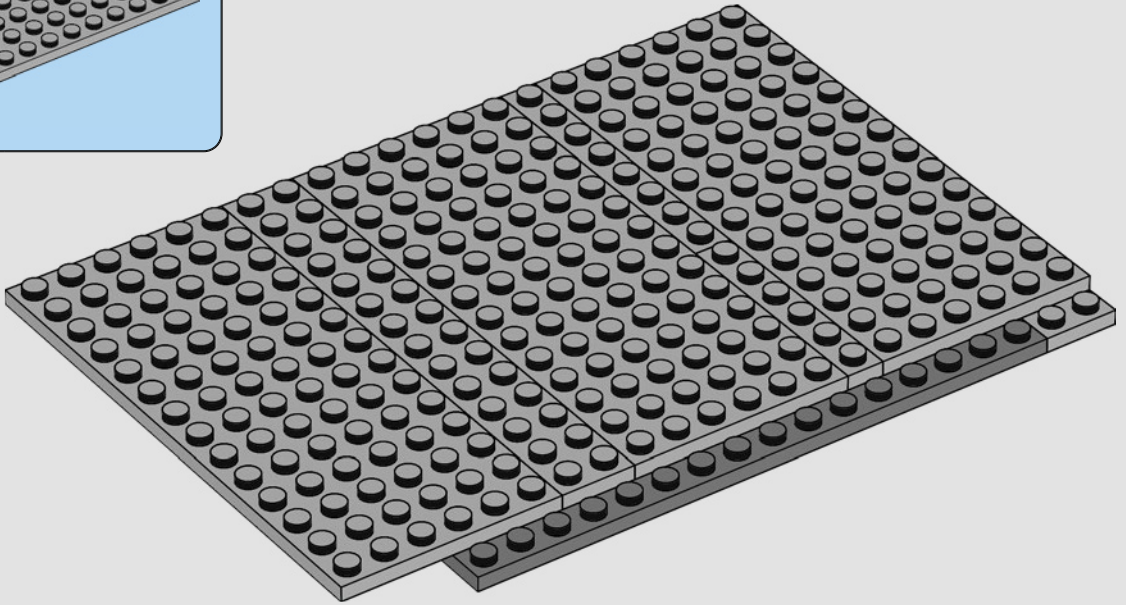

**167**

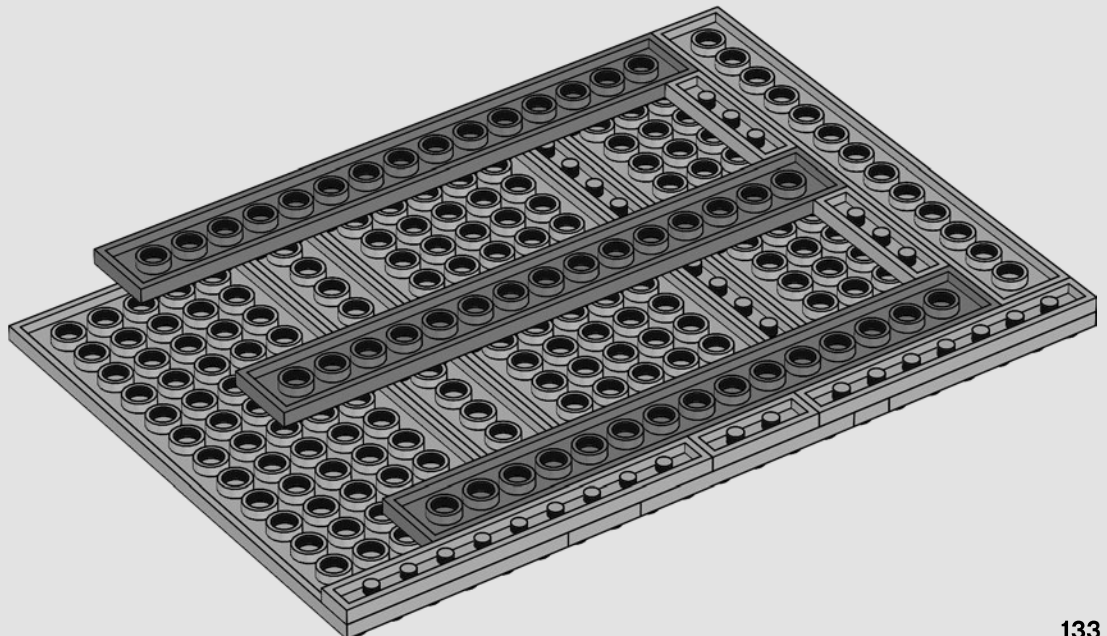



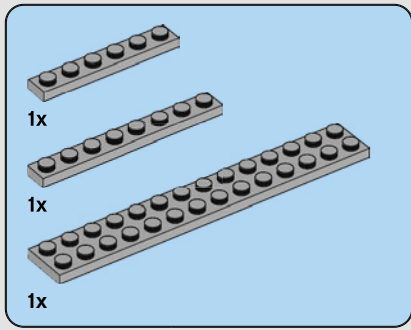

168

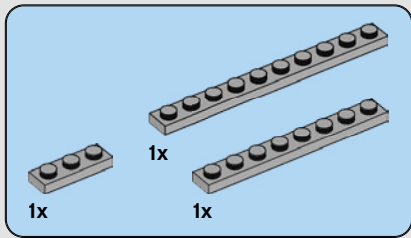
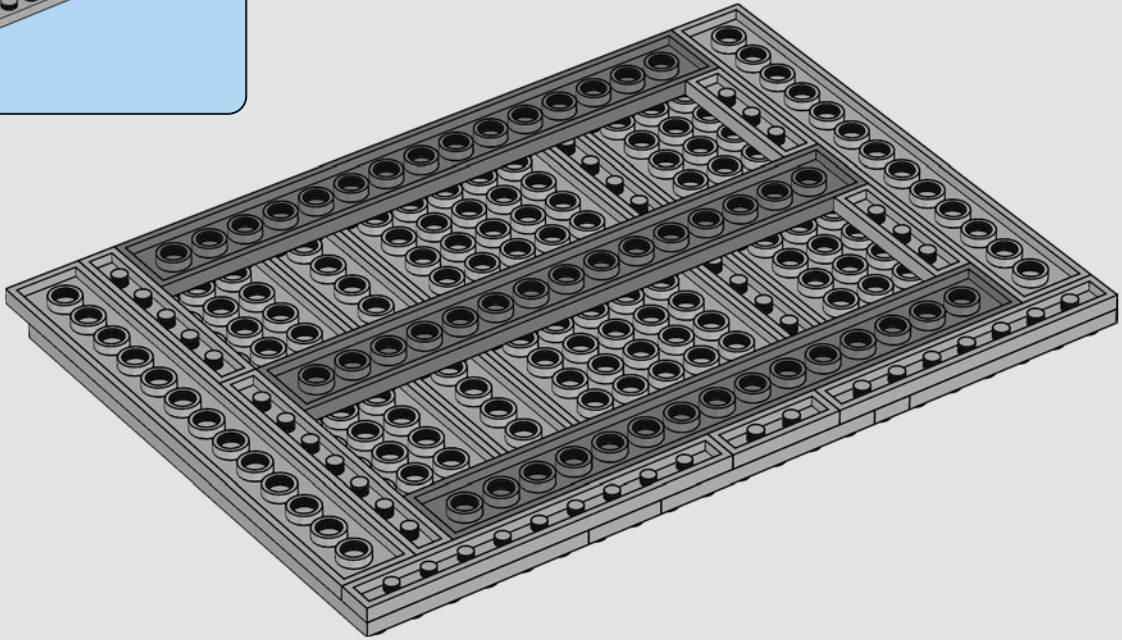

169

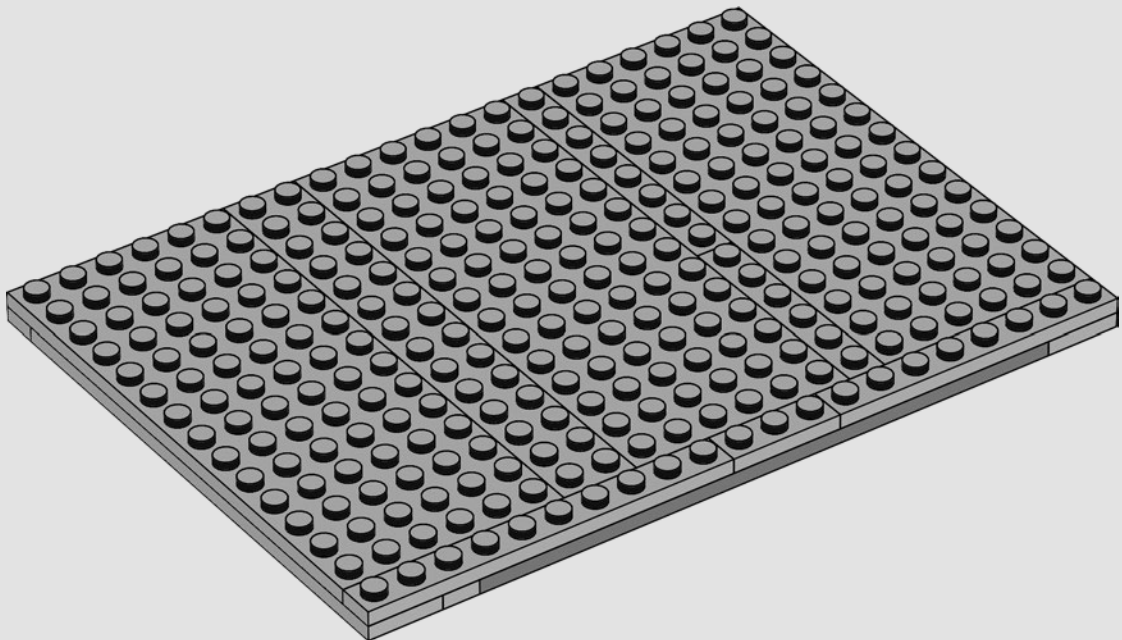

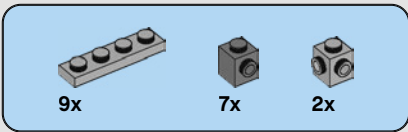

170

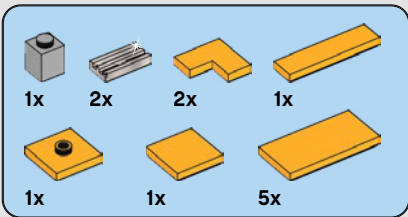
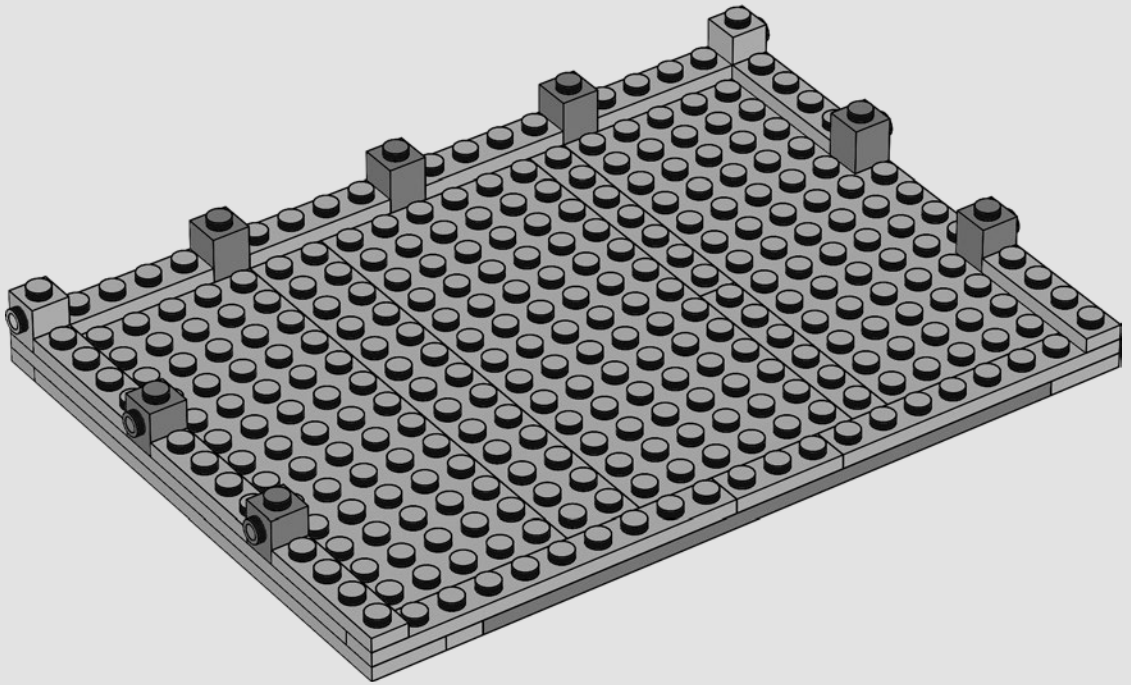

171

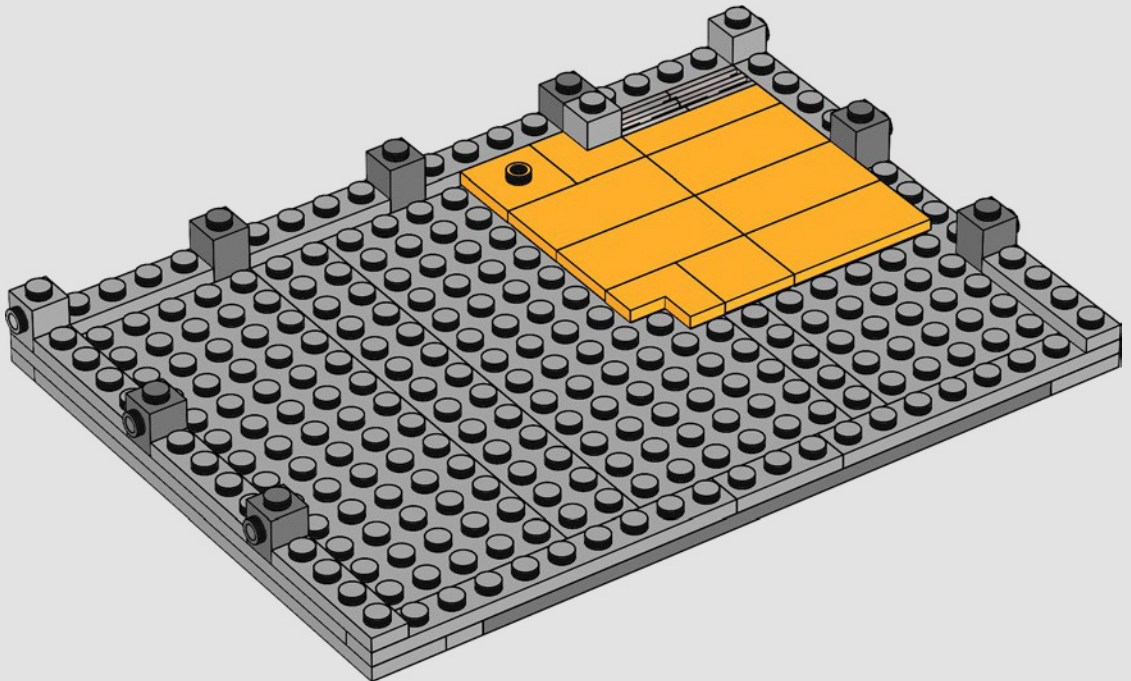



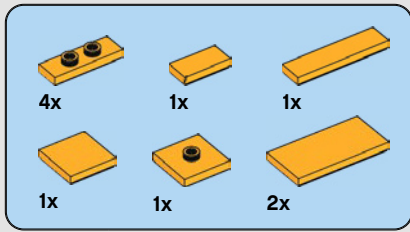

172

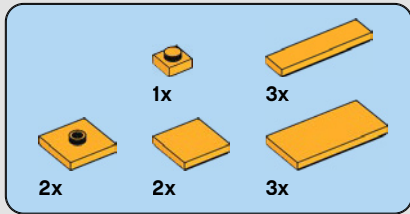
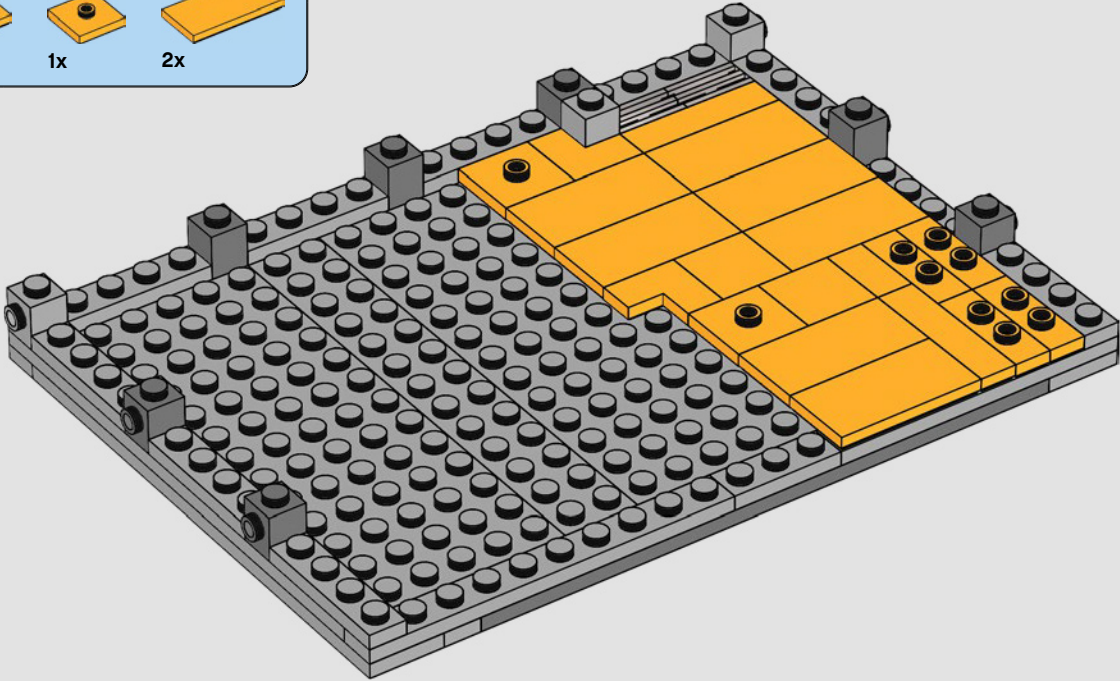

173

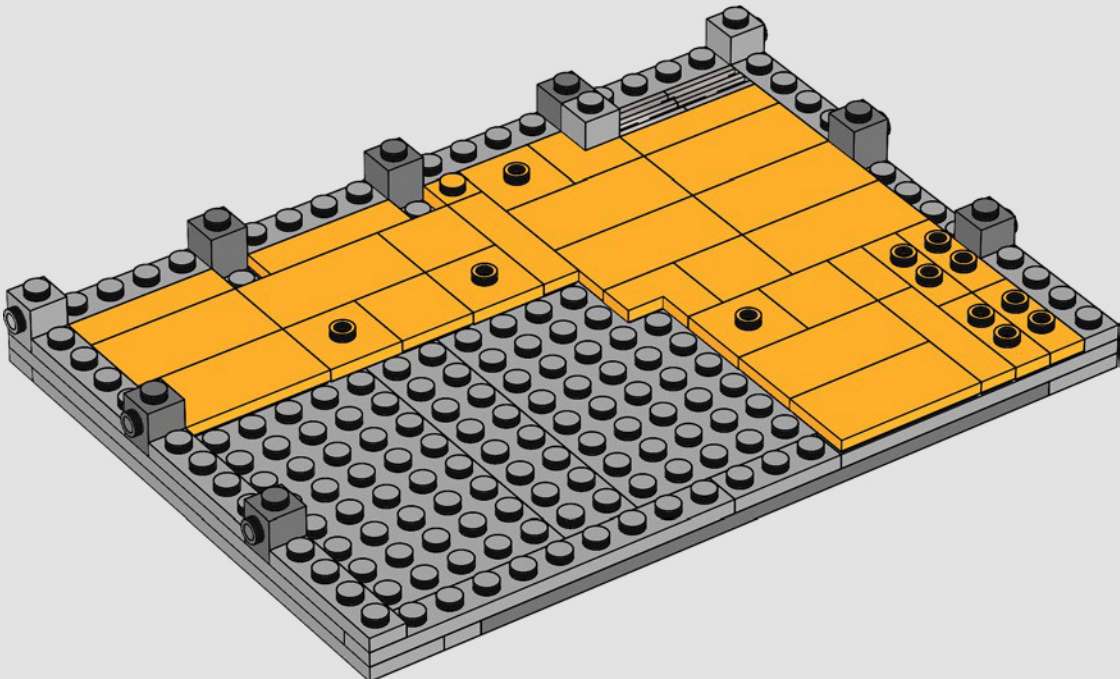

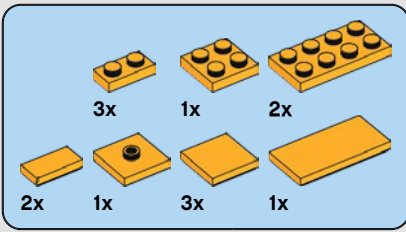

174

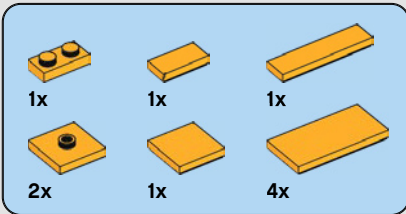
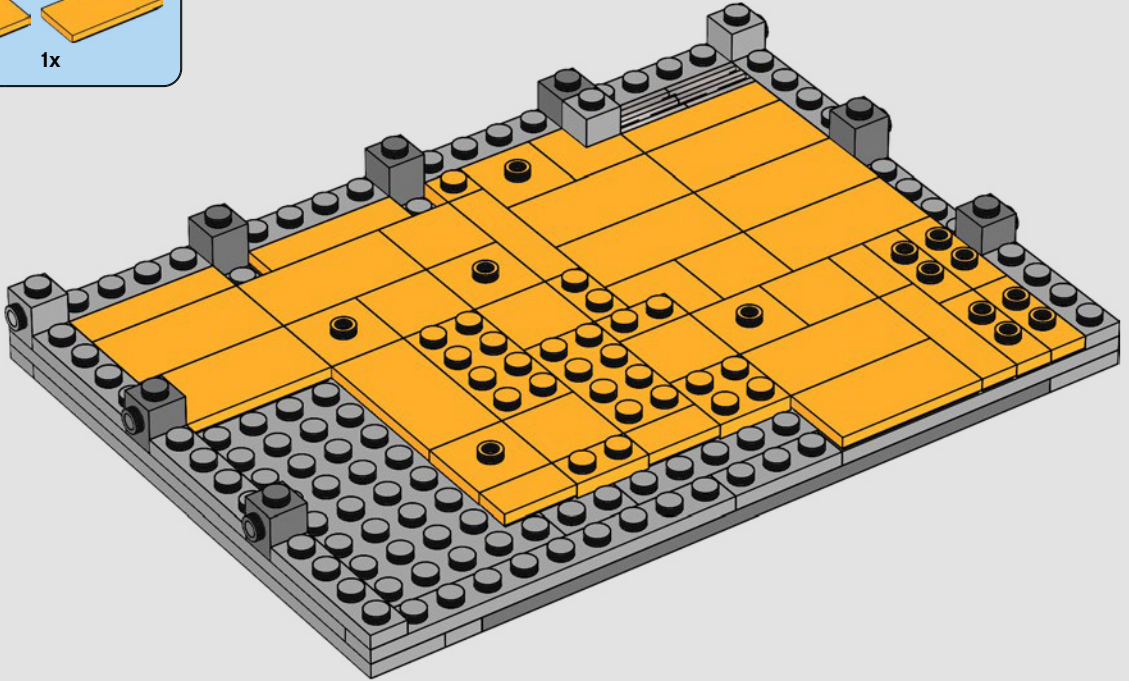

175

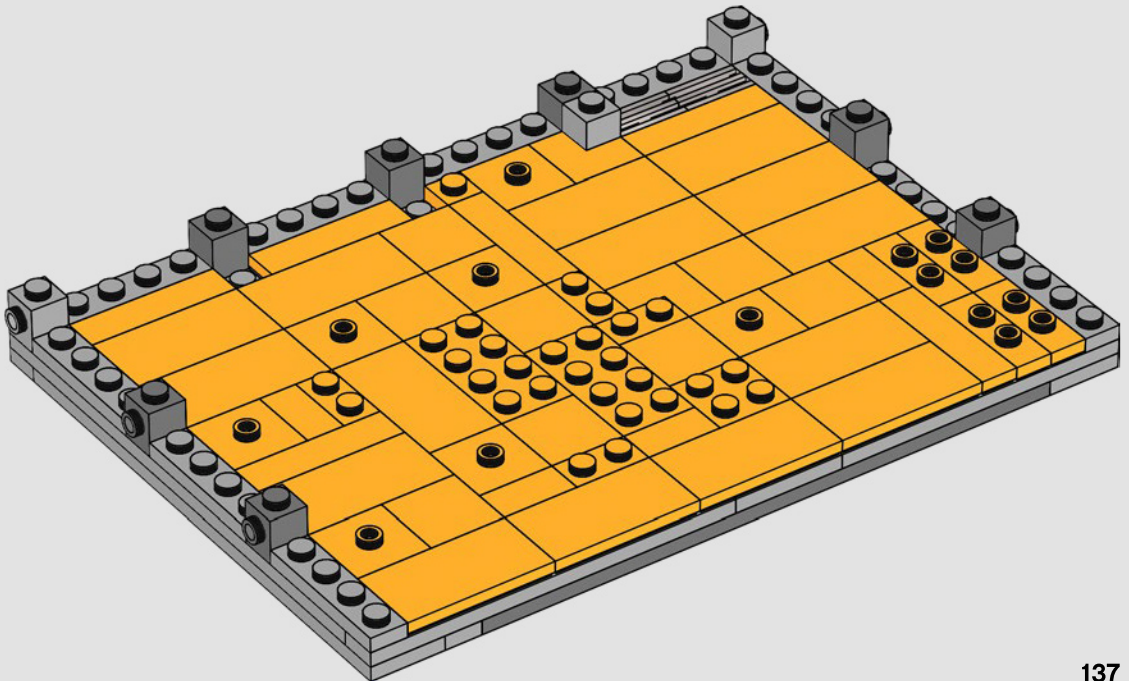



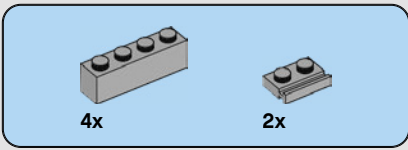

# 176

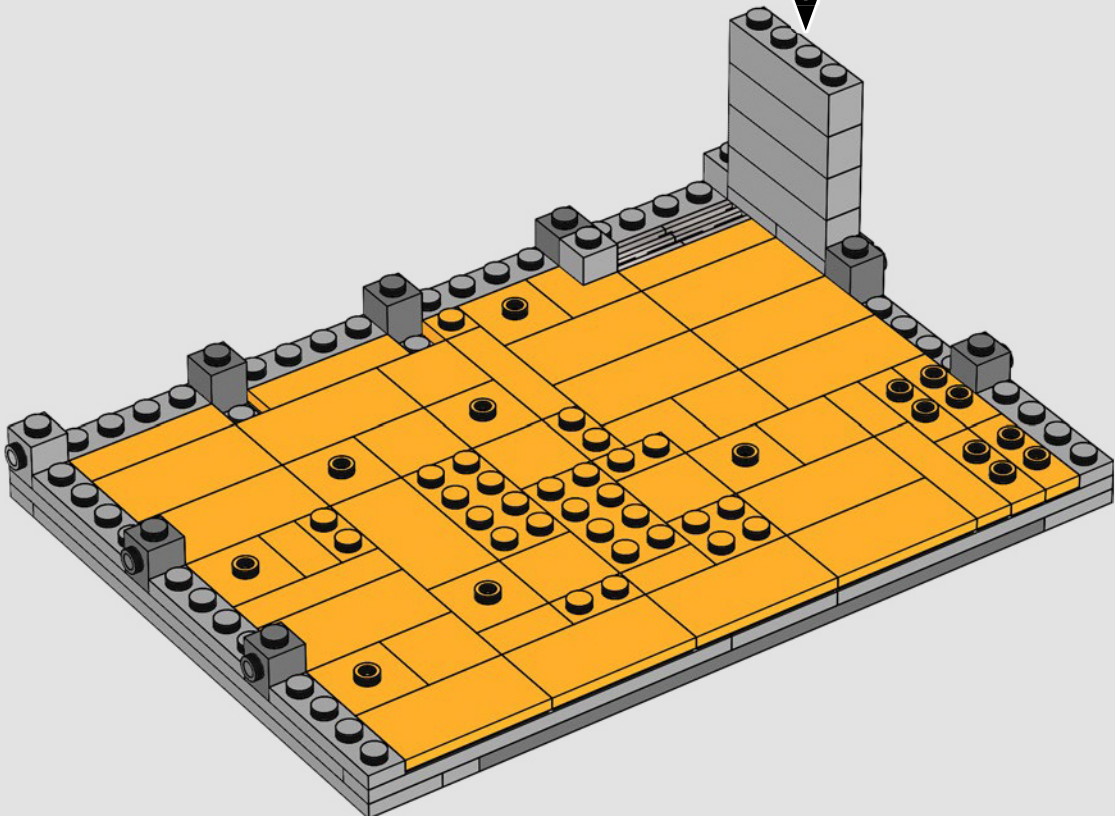
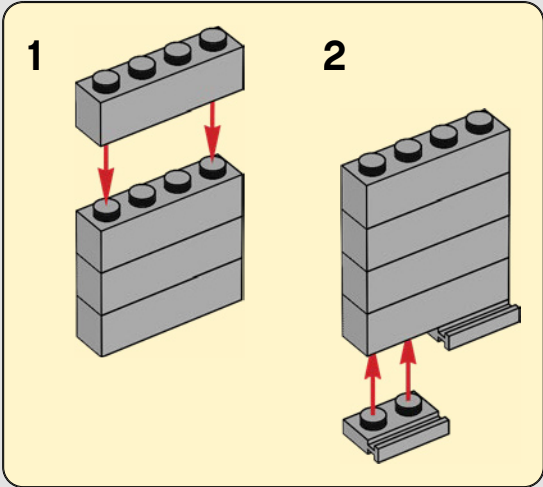

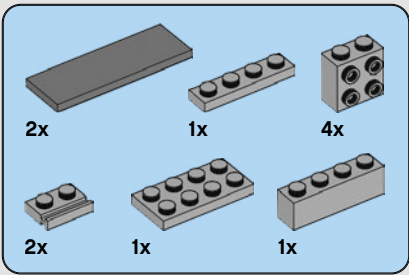

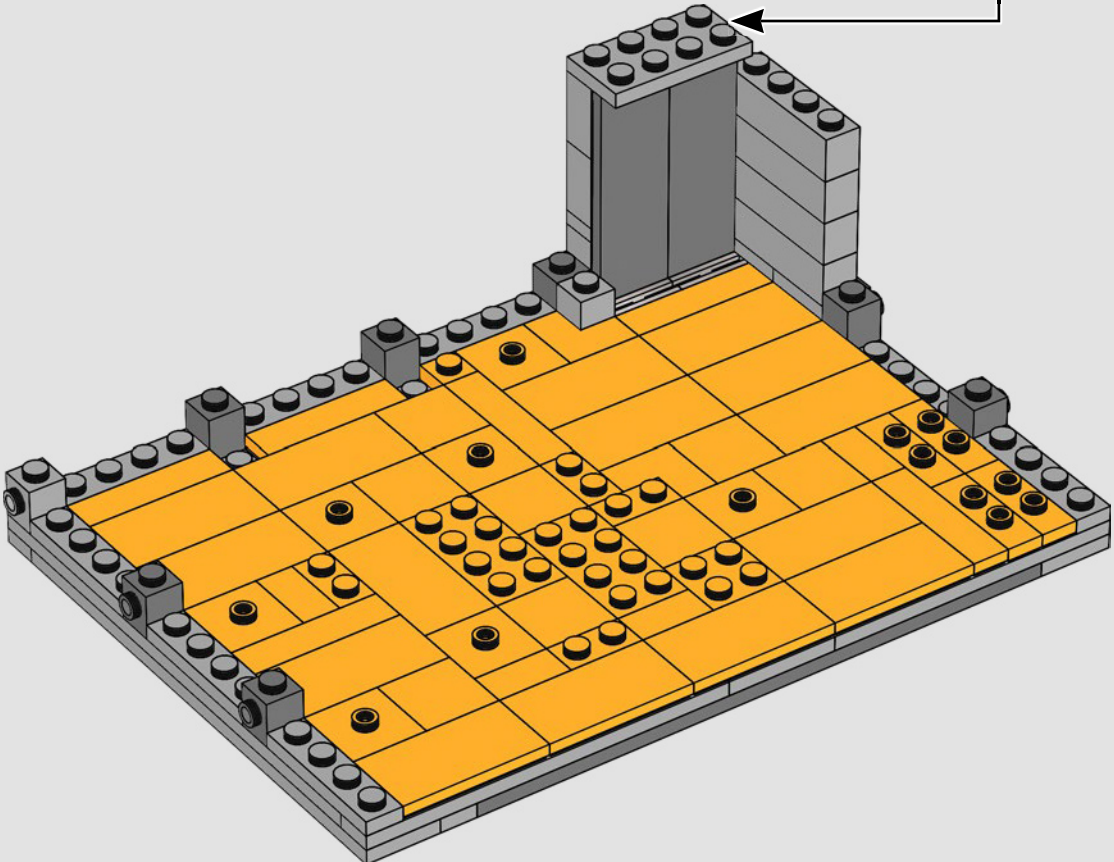
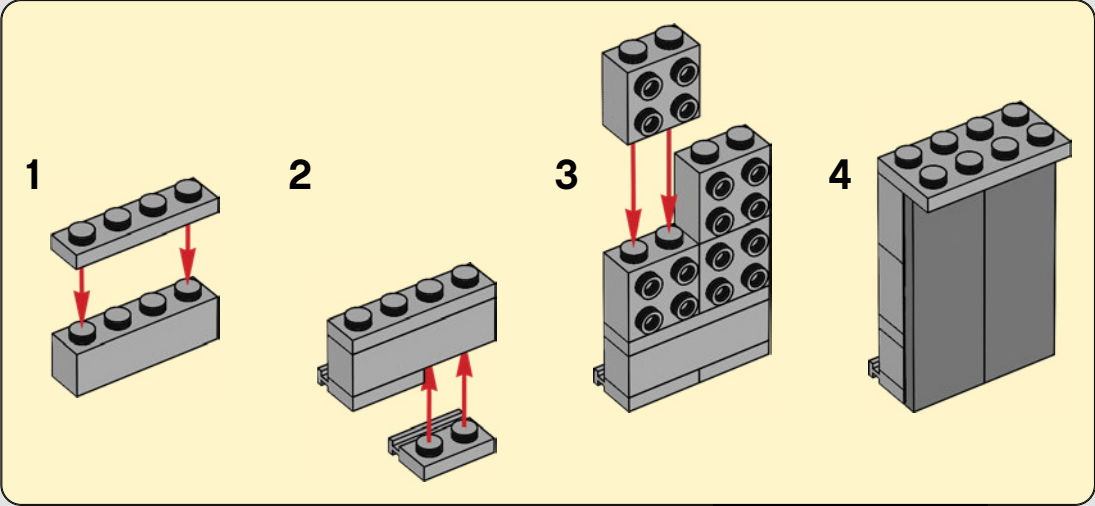

177





		
3x	5x	2x

# 178

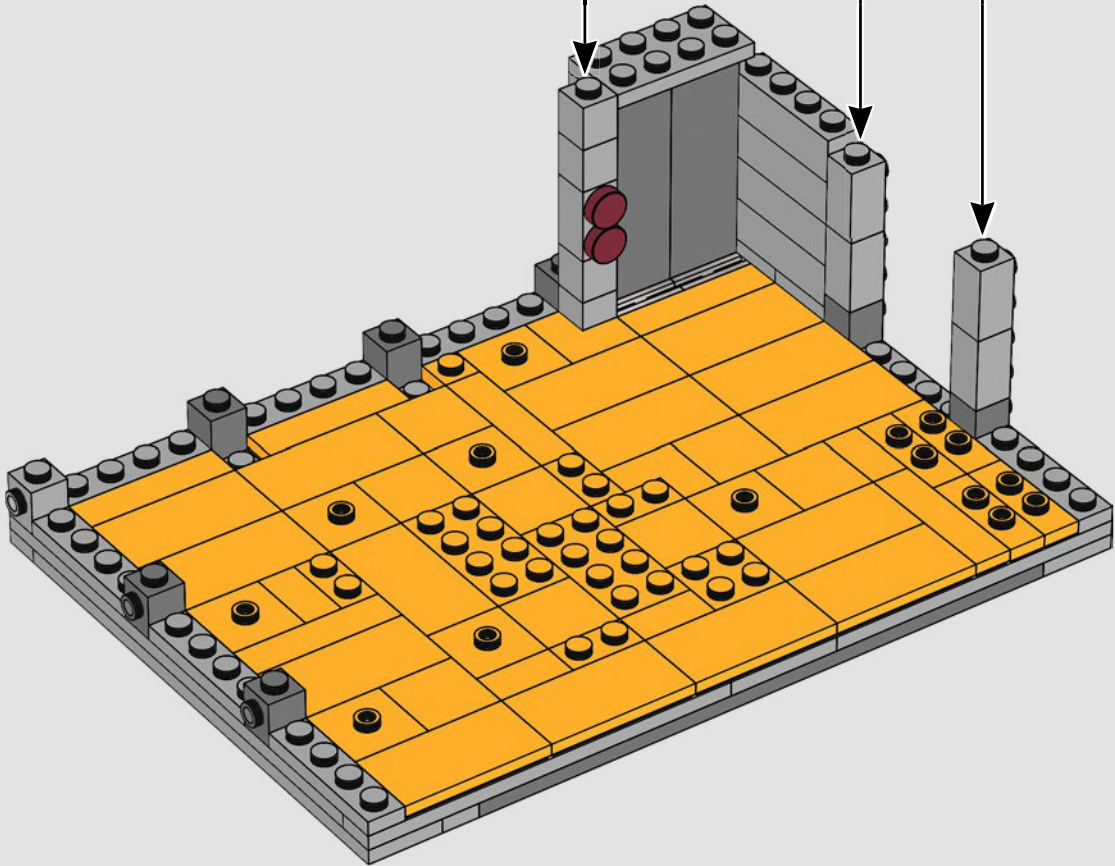
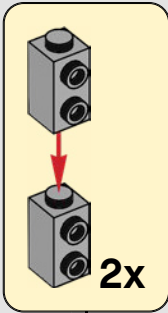
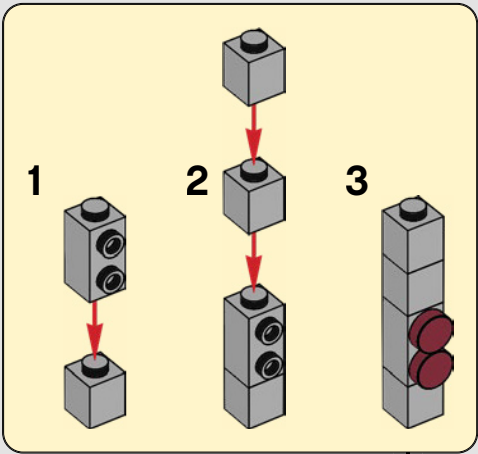

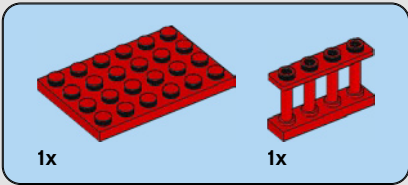
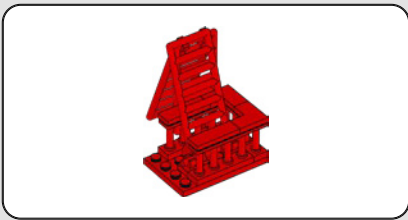

179

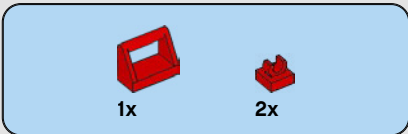
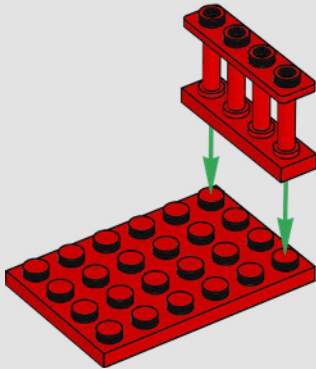

180

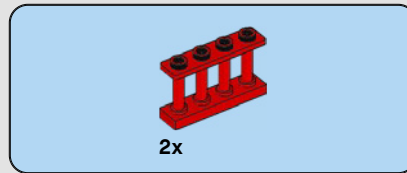
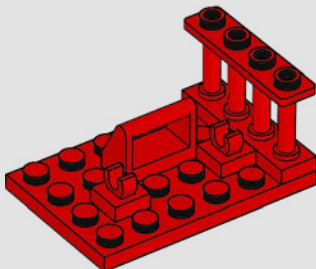

181

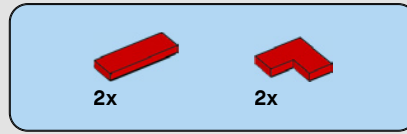
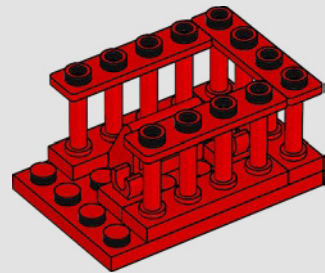

182

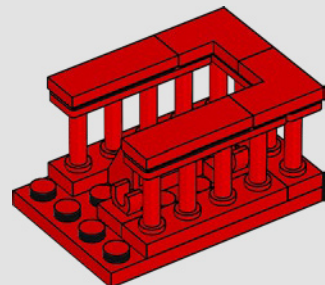





183

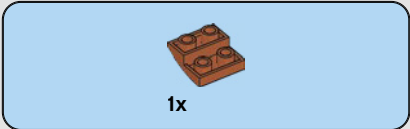
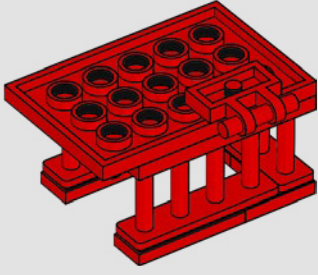

184

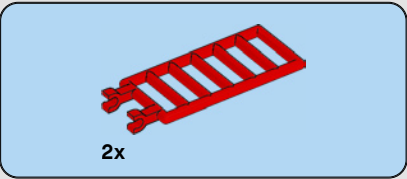
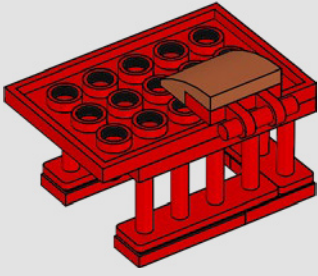

185

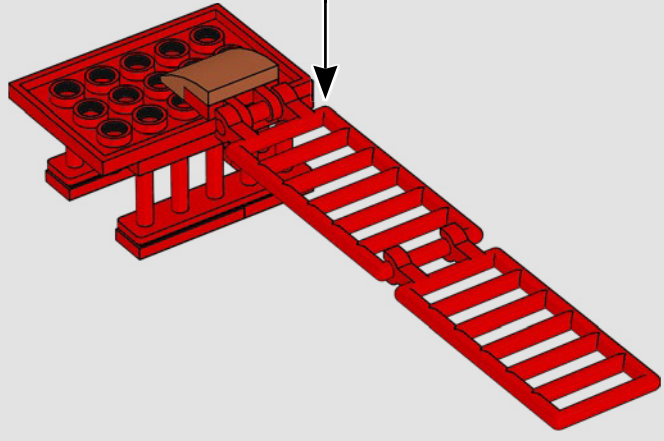
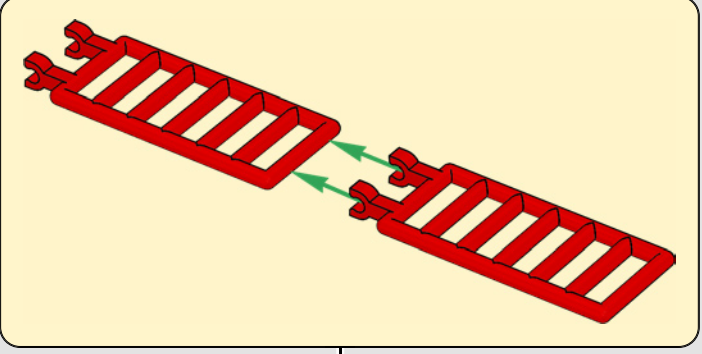

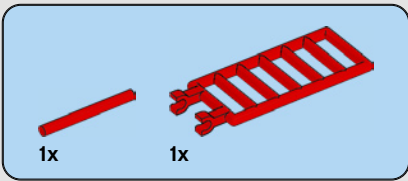

186

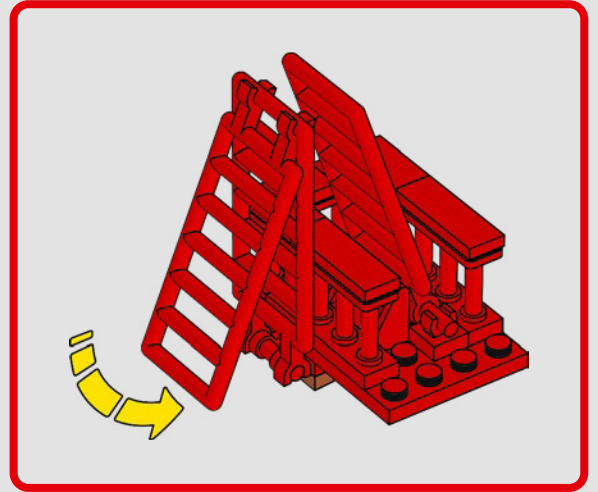
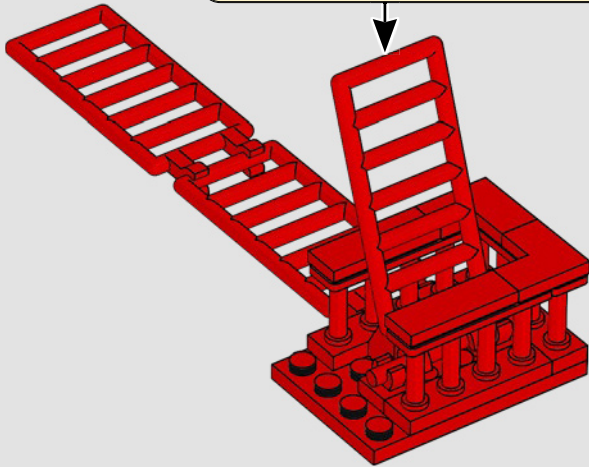
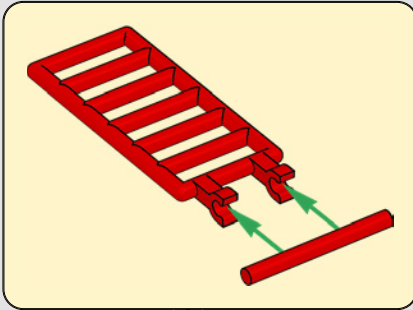

187

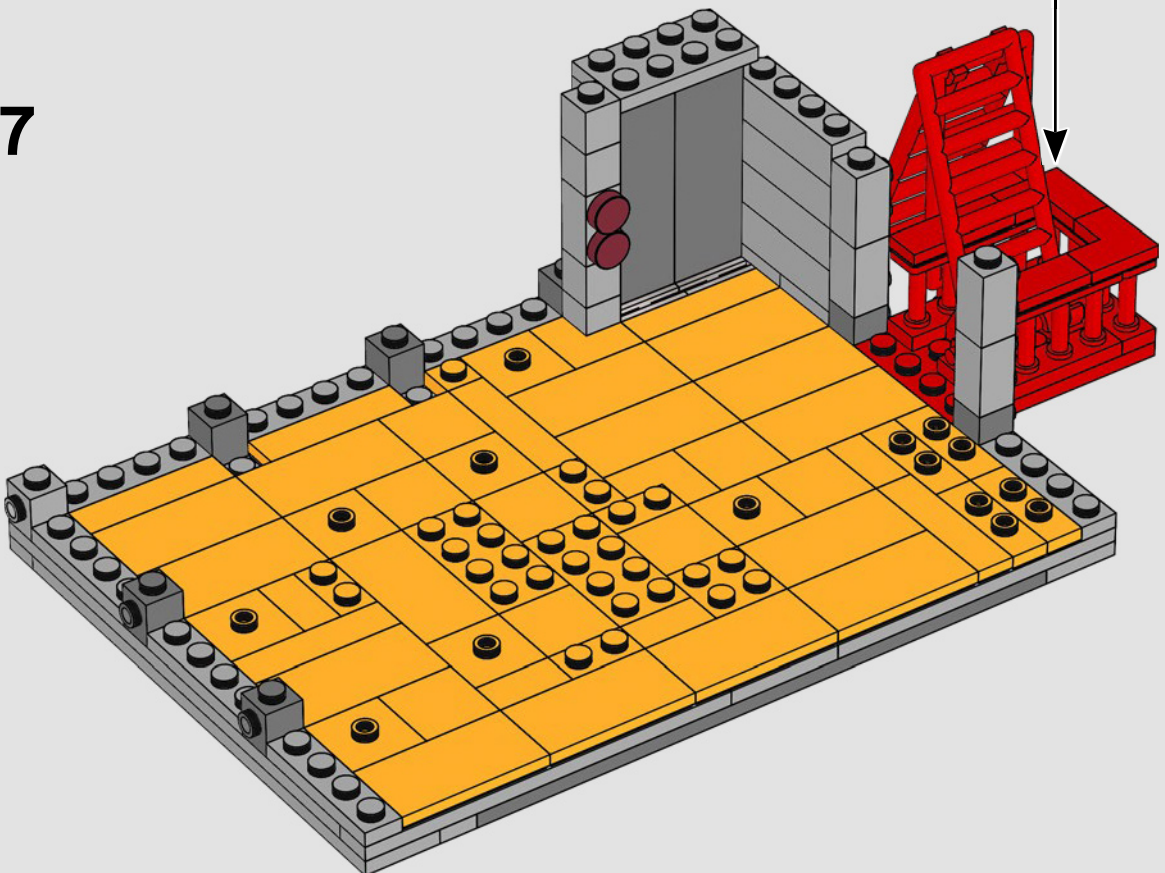



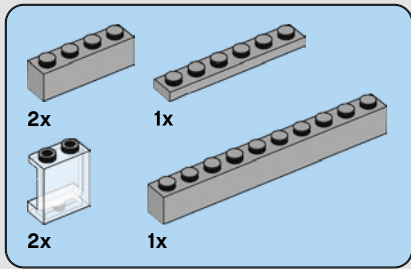

188

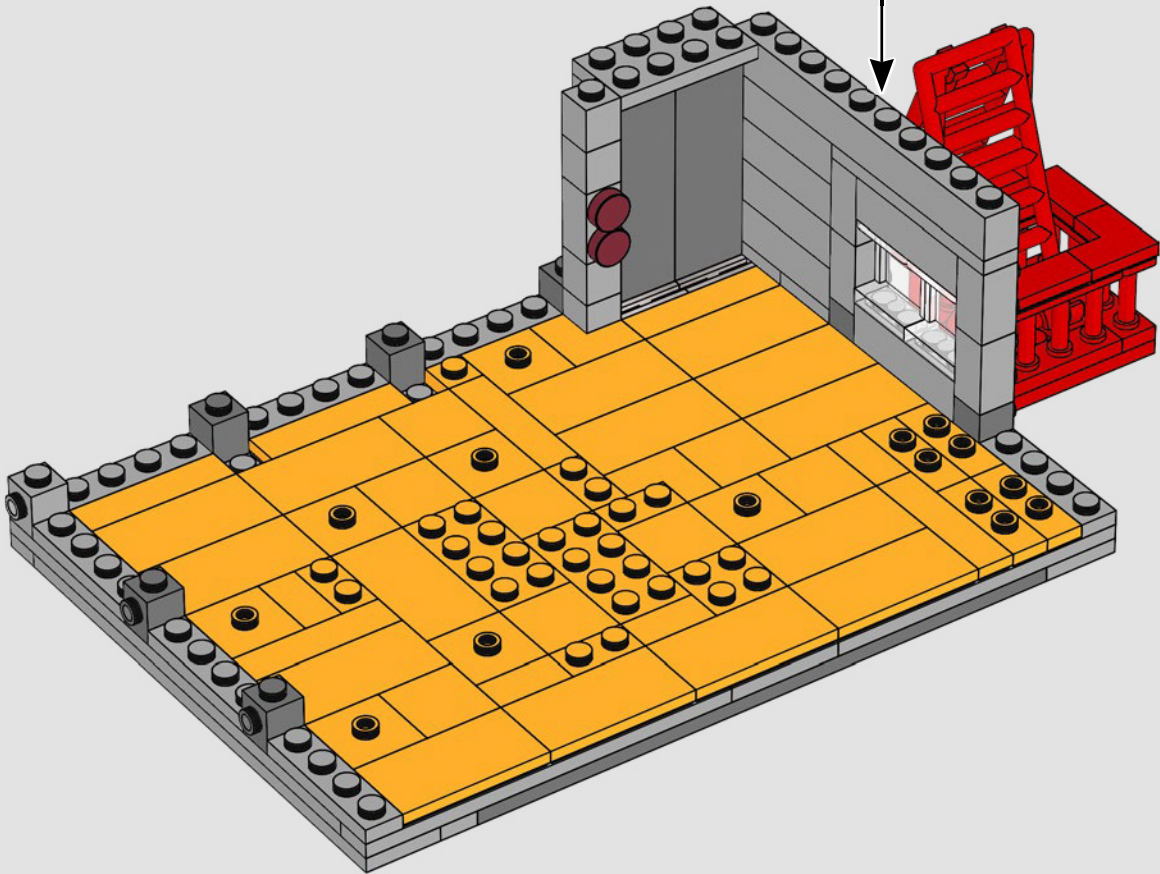
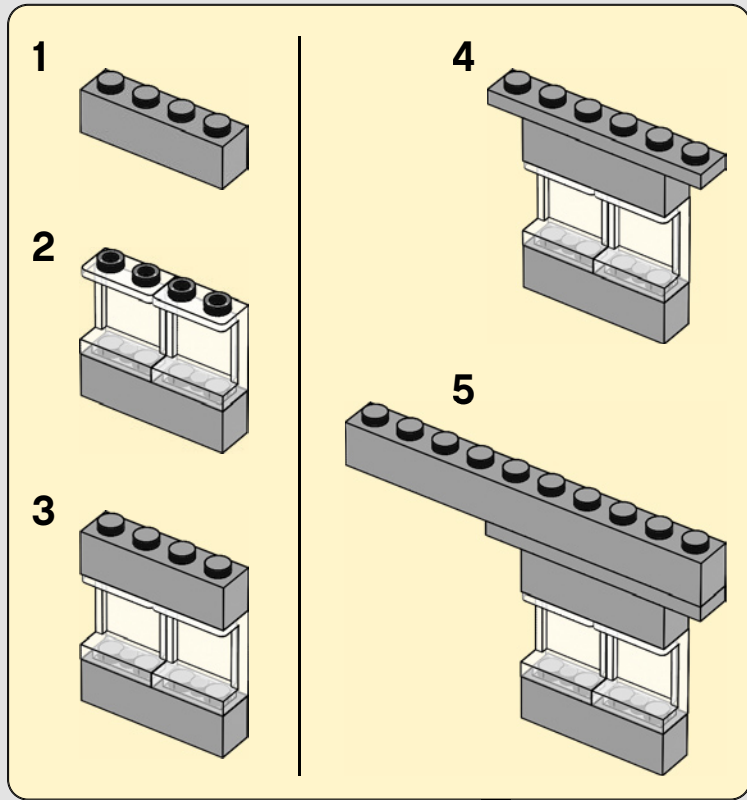

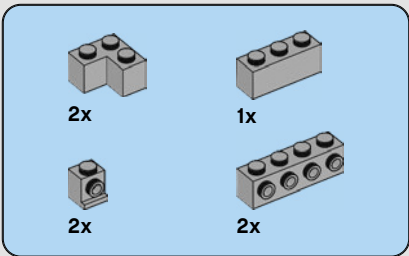

189

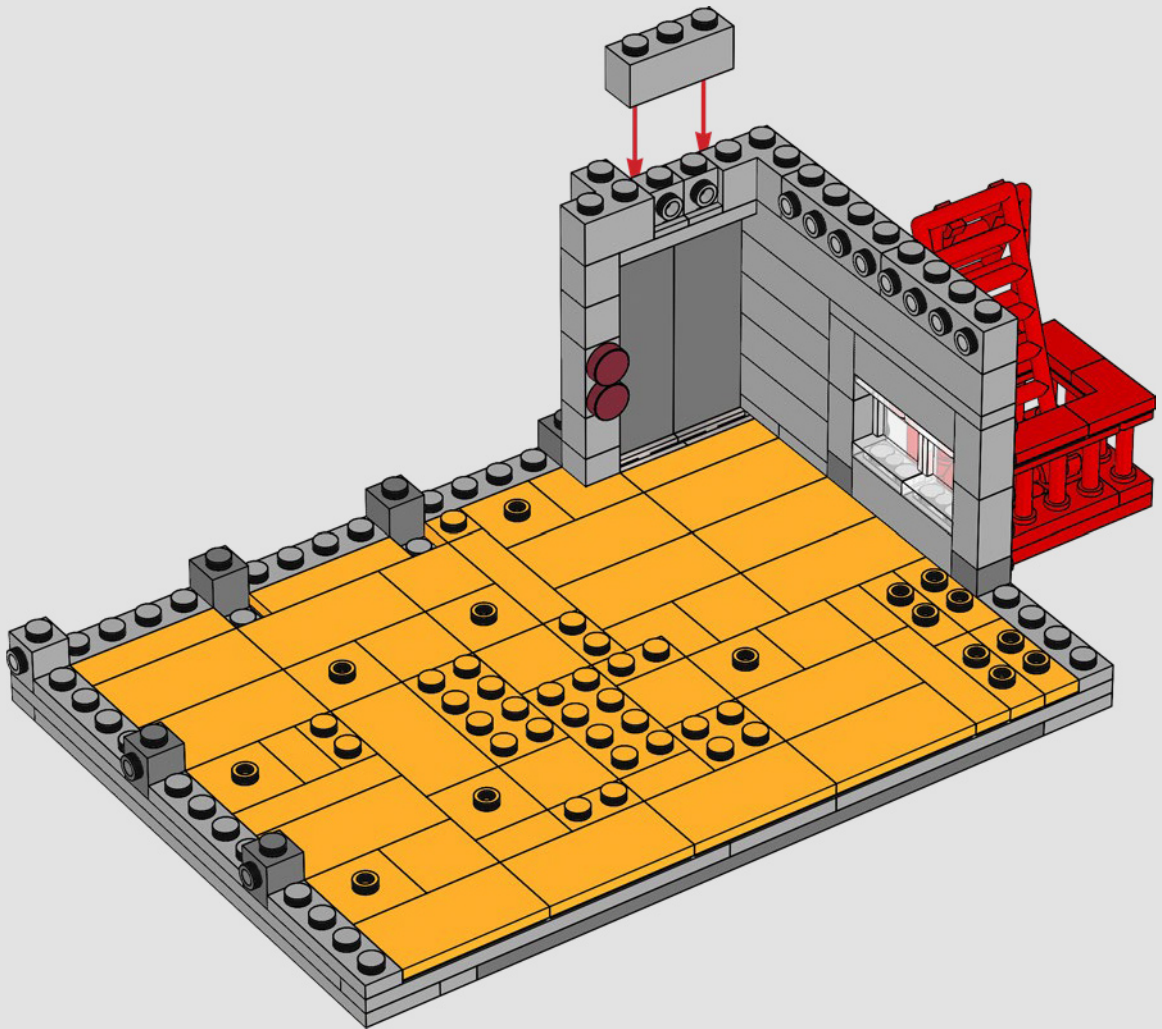



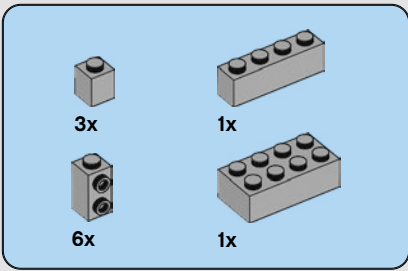

190

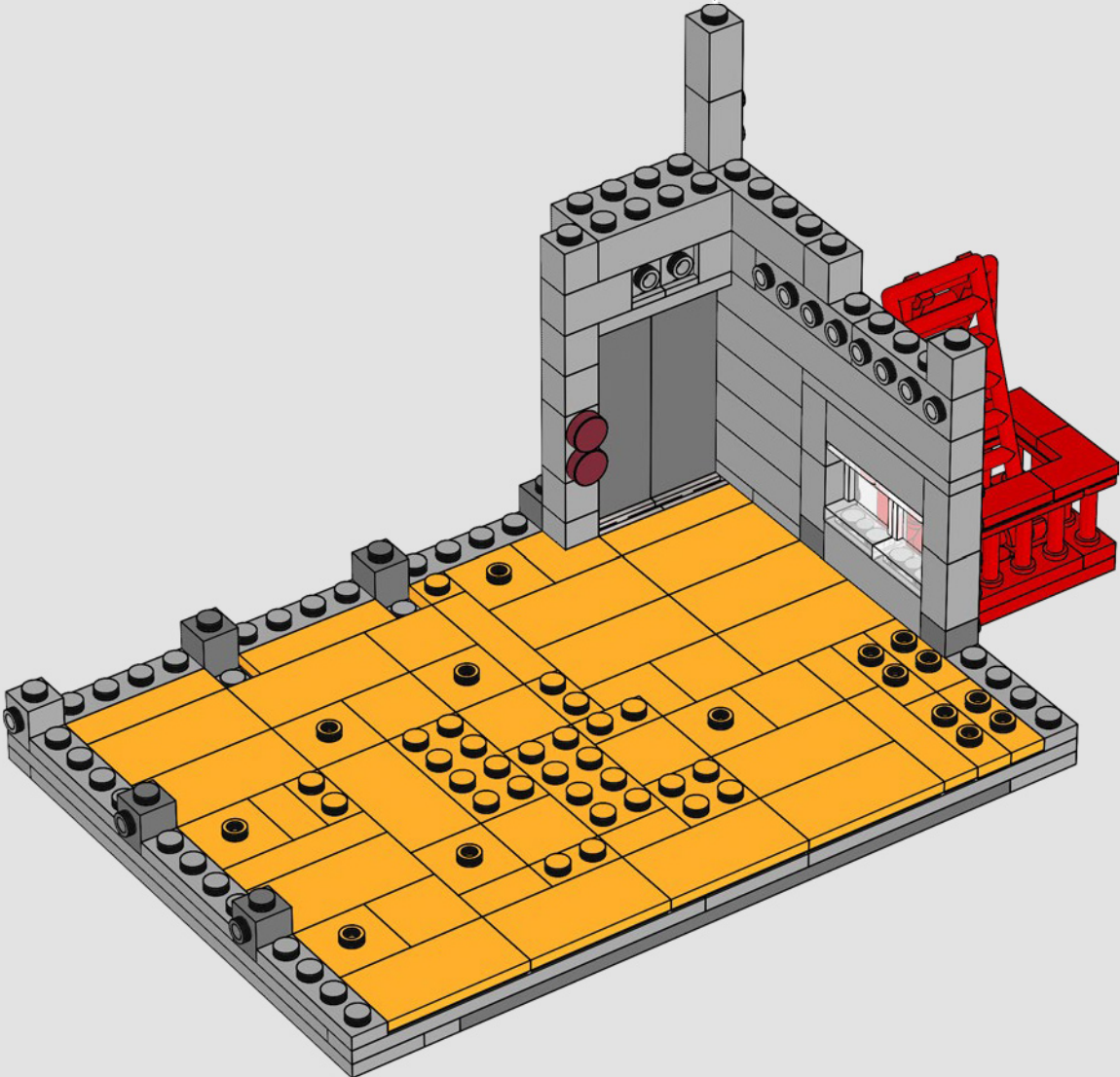
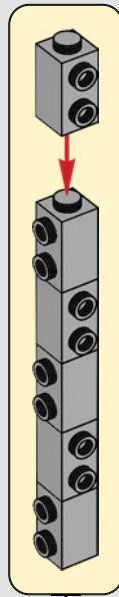

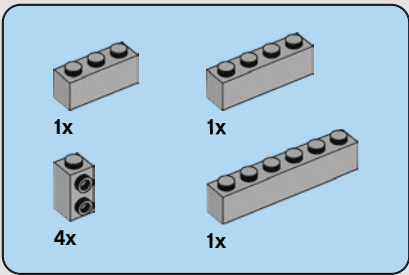

191

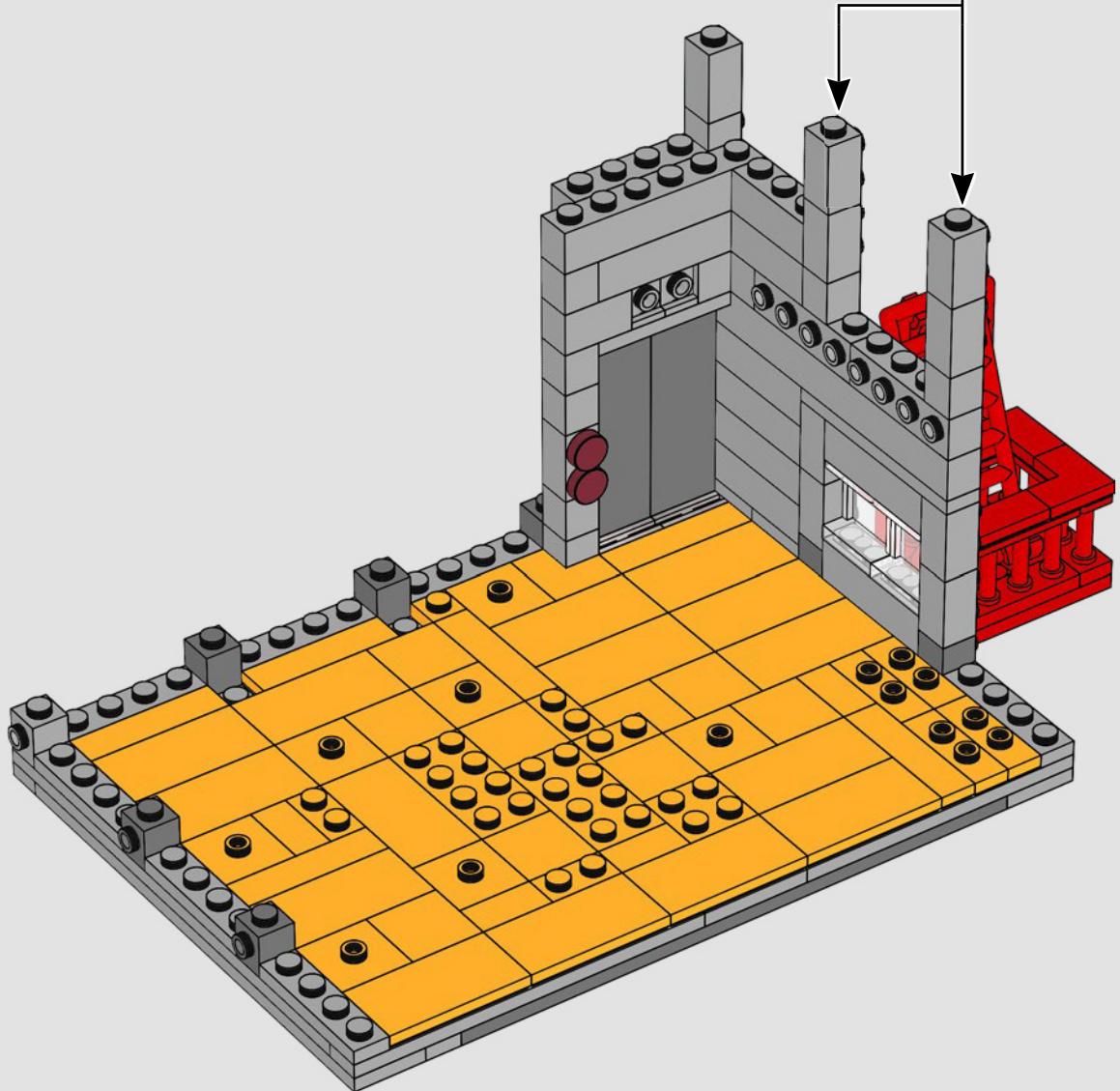
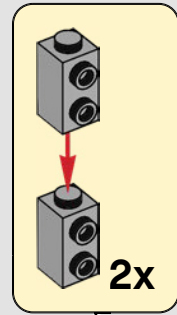





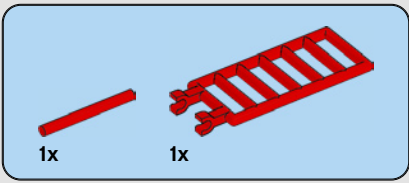

196

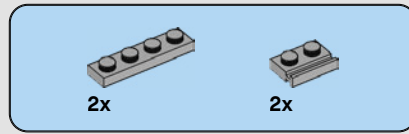
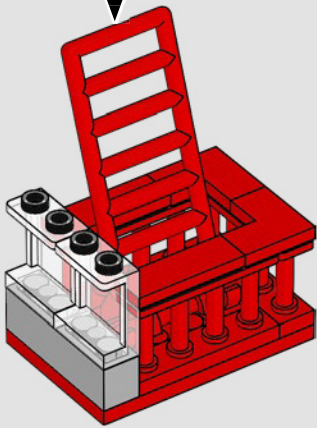
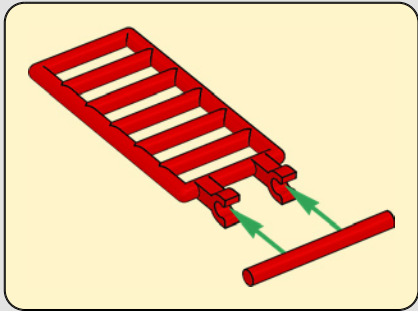

197

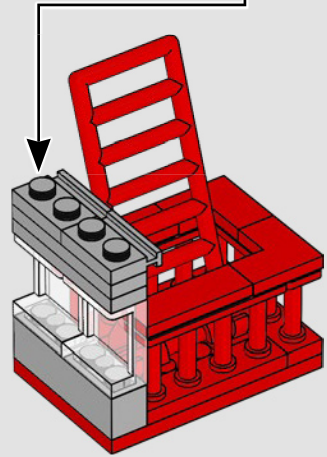
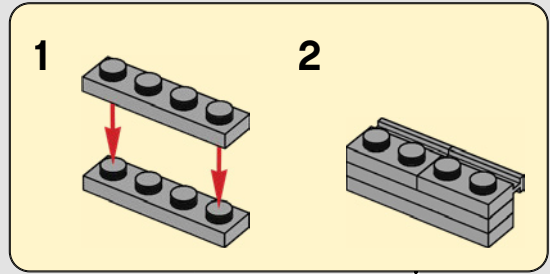

198

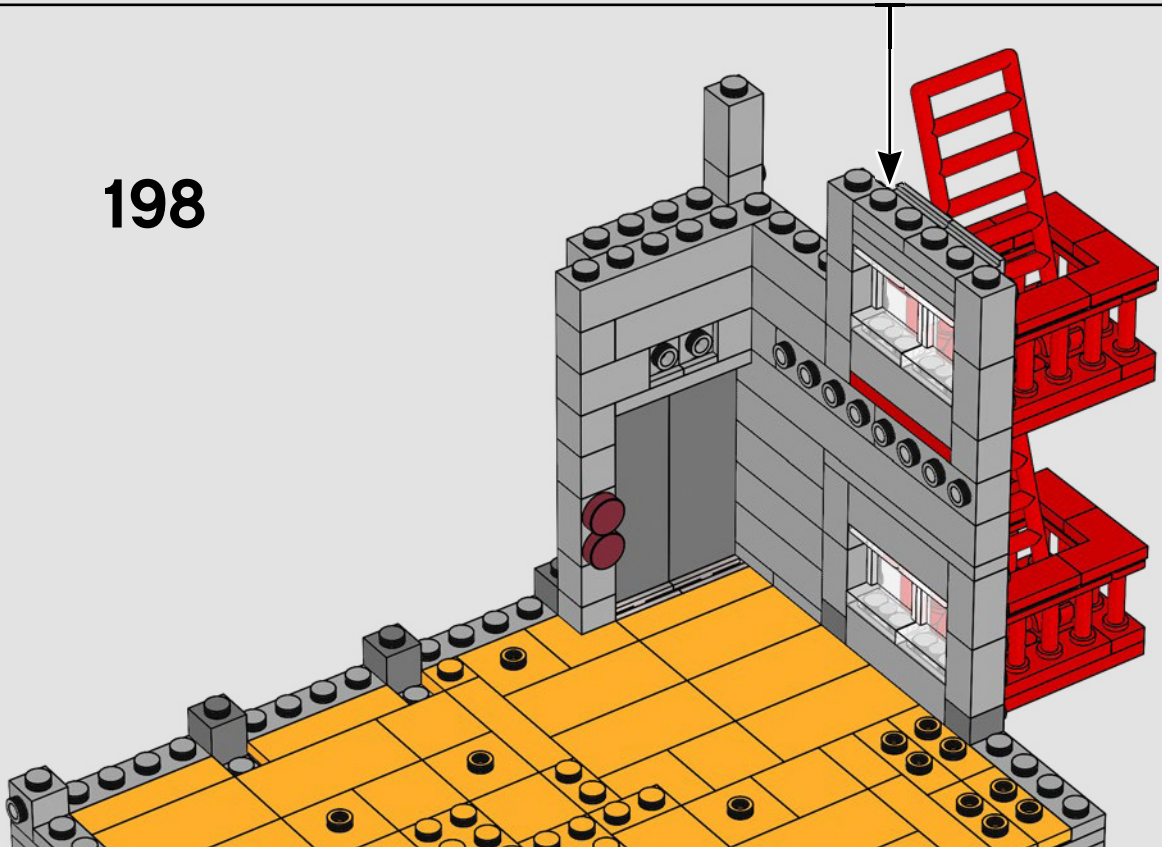



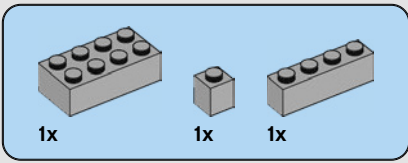

# 199

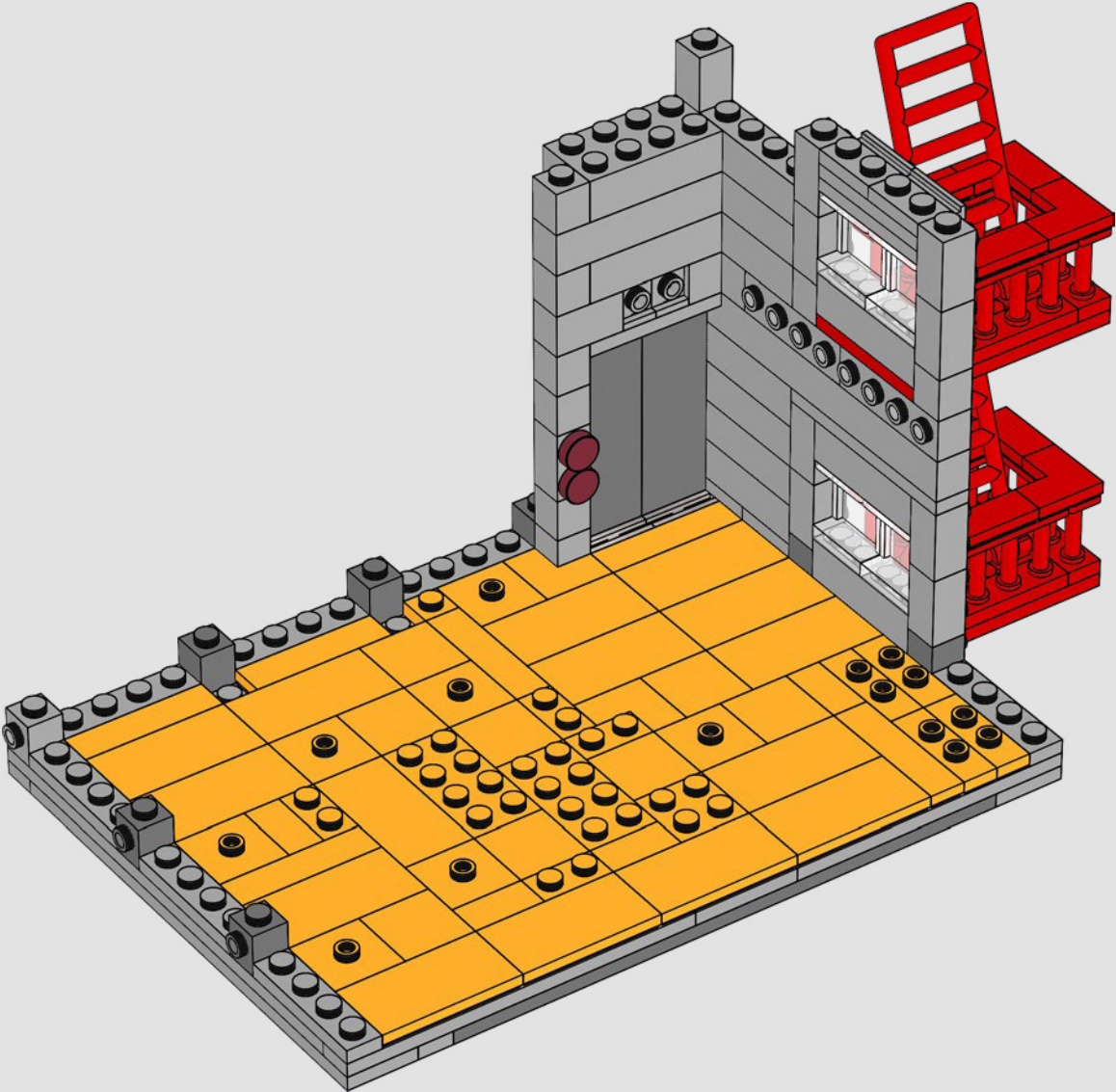

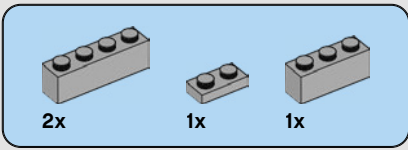

200

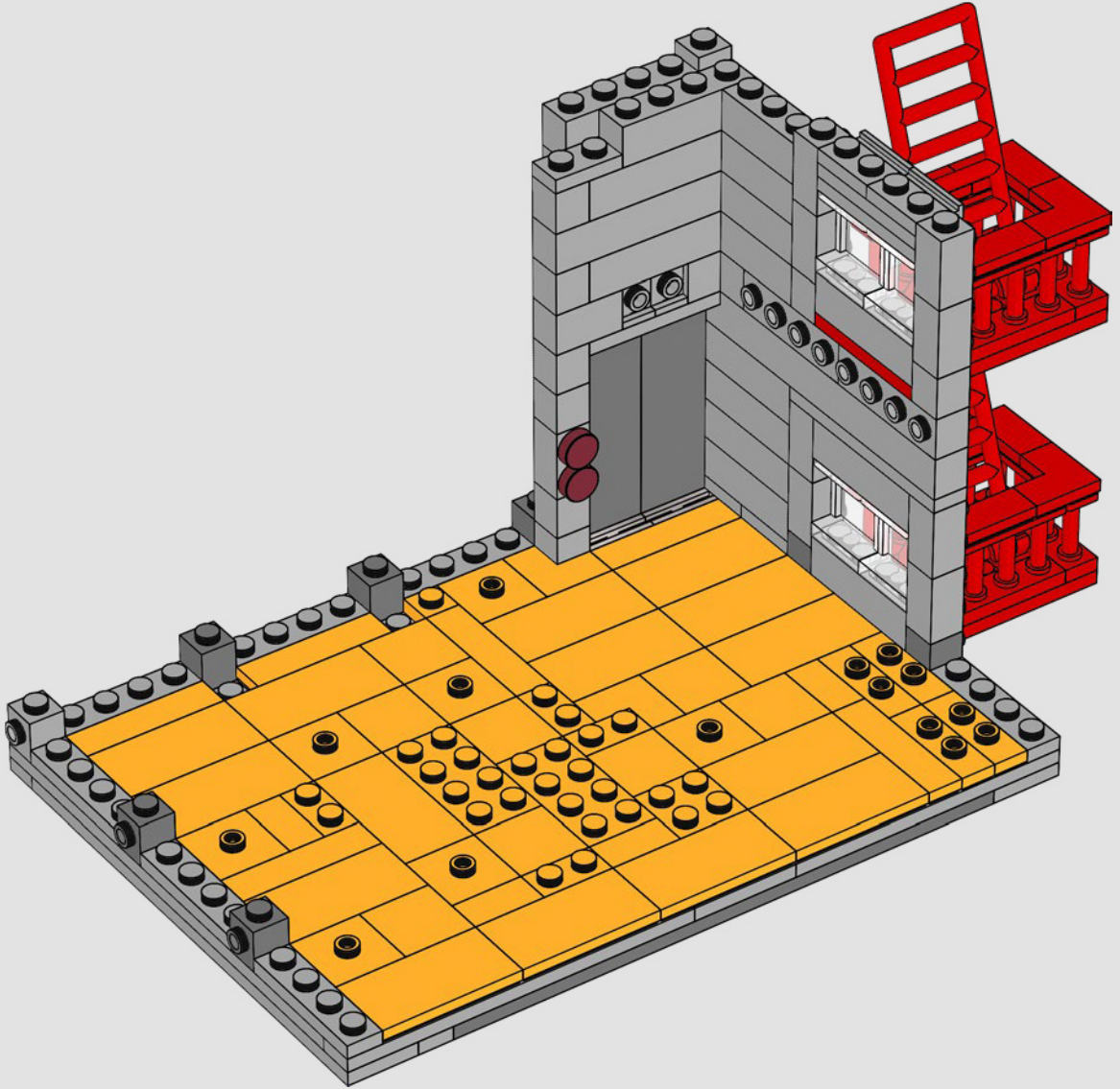



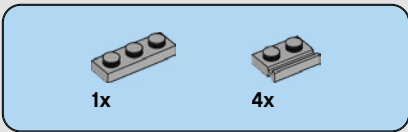

# 201

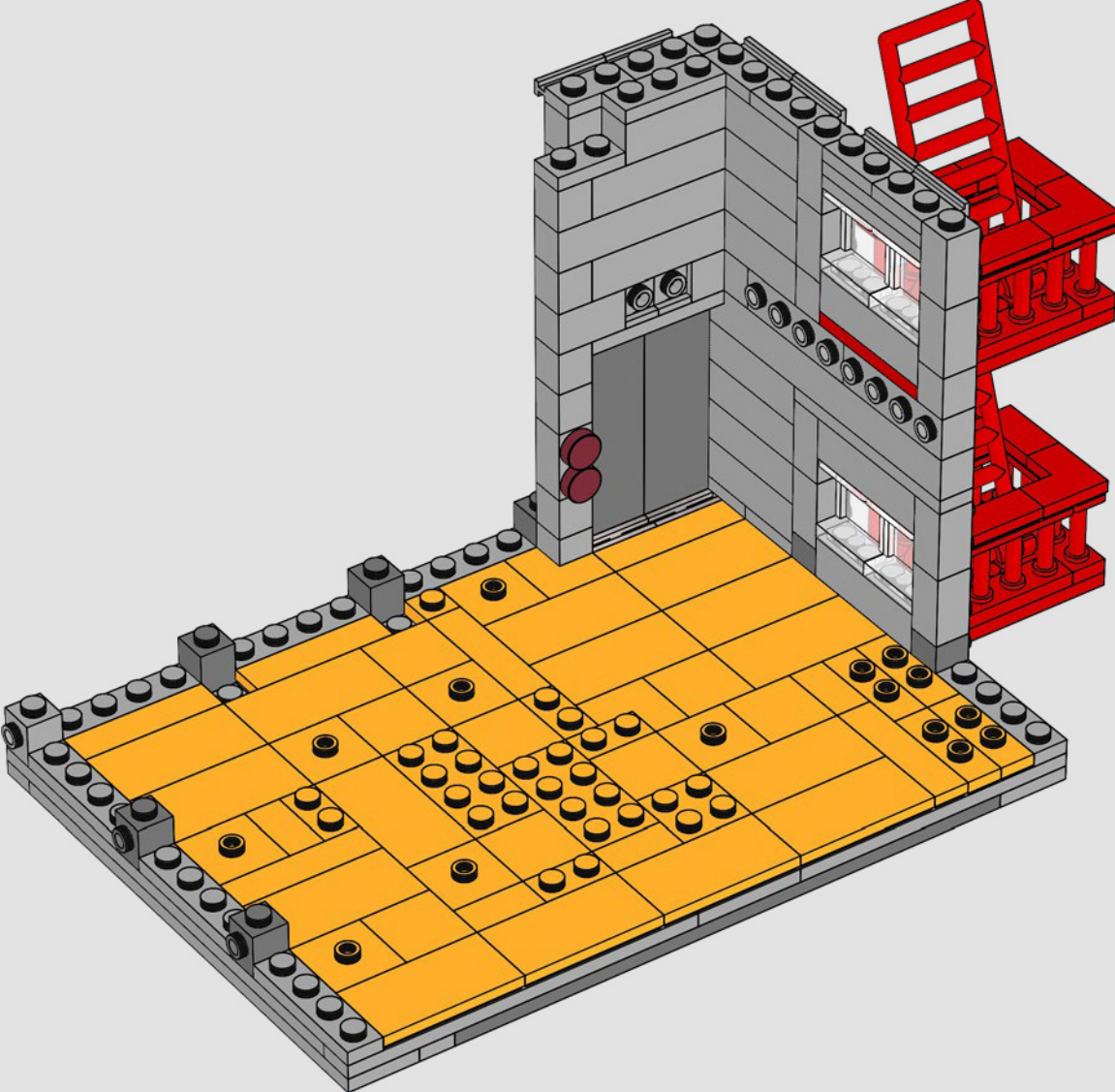

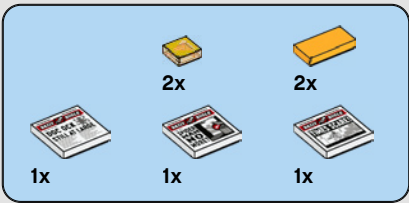

202

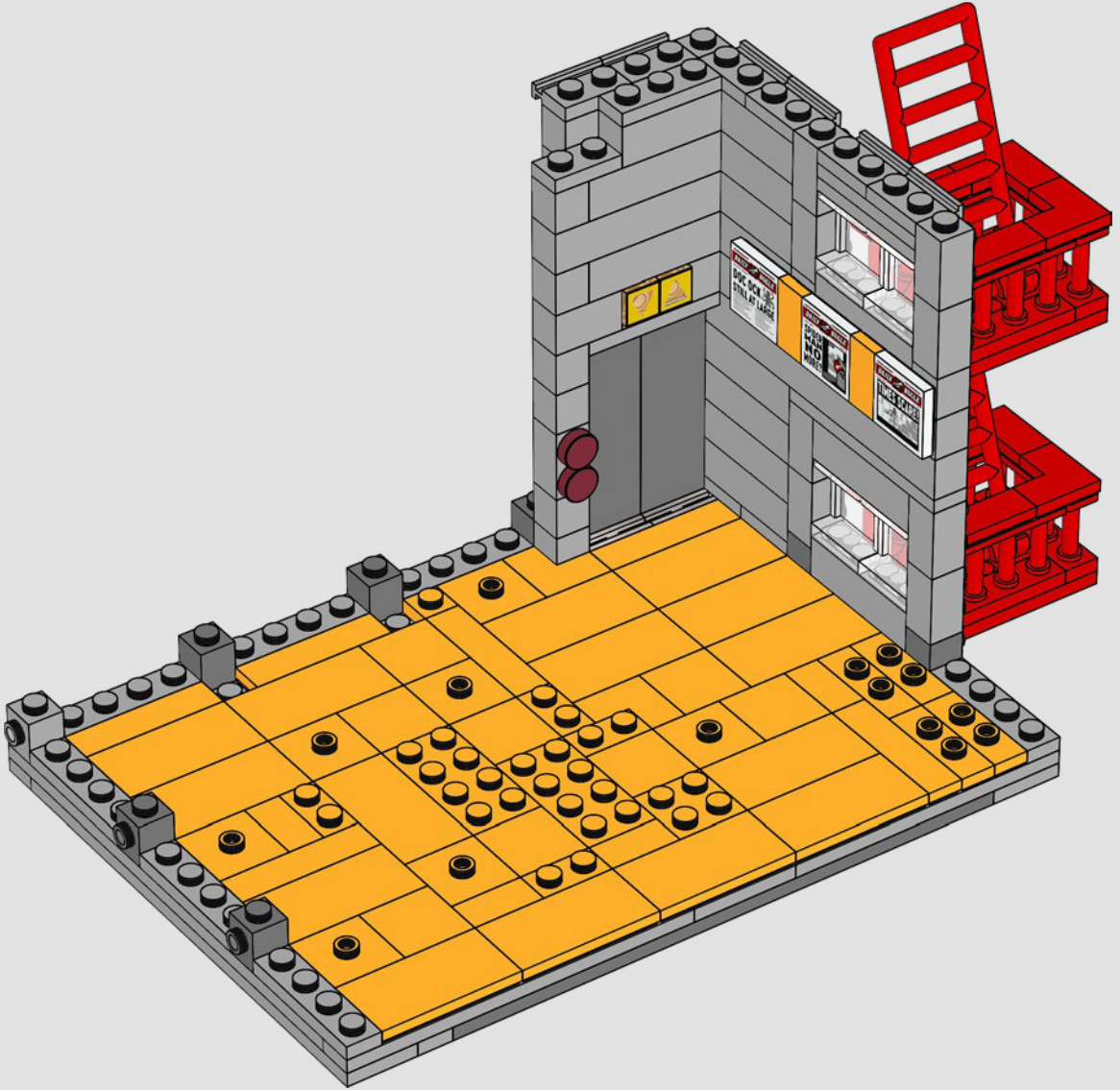



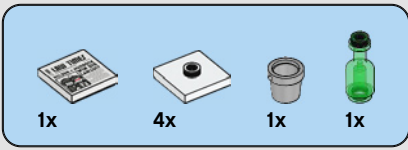

# 203

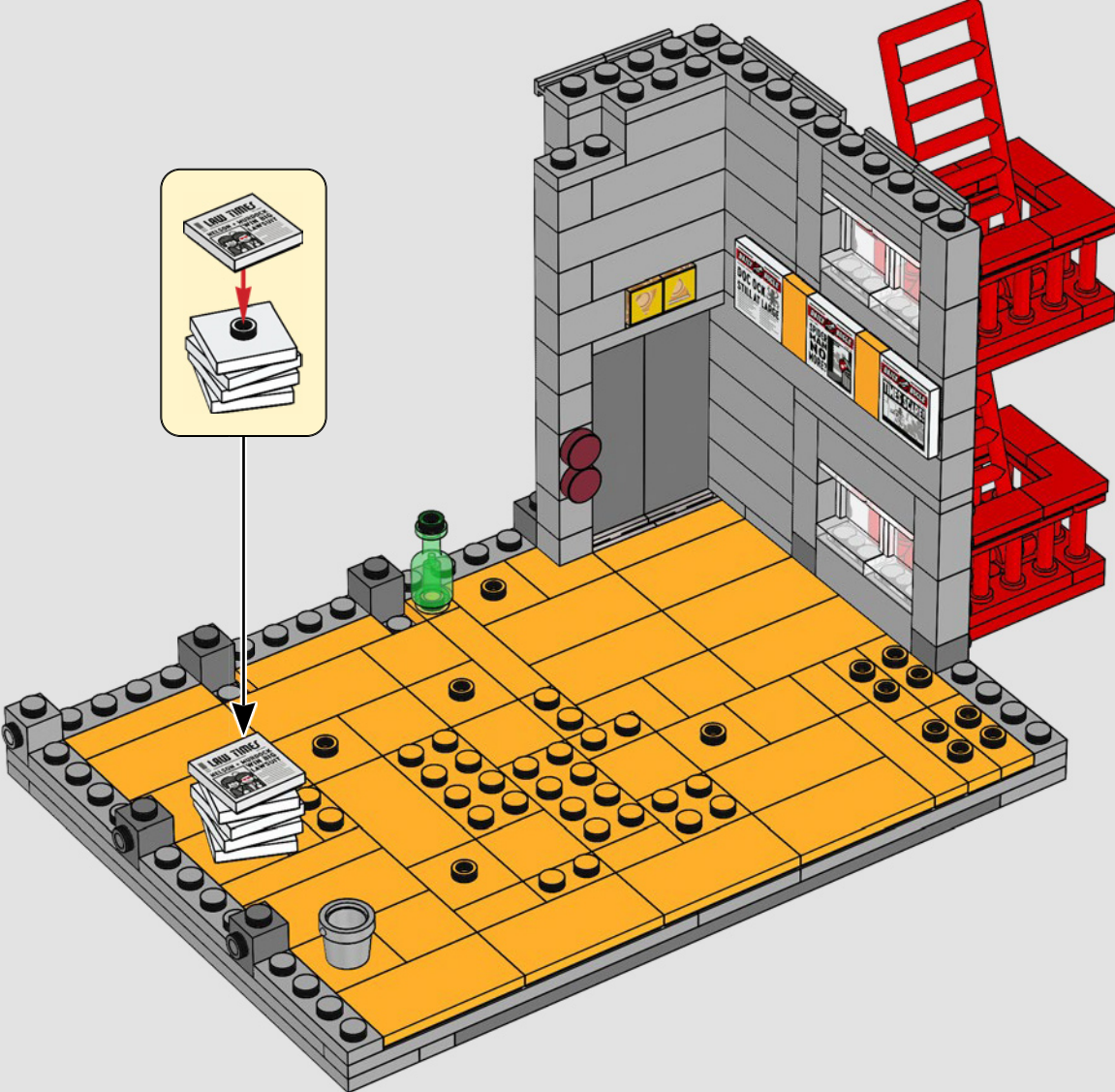



# 204

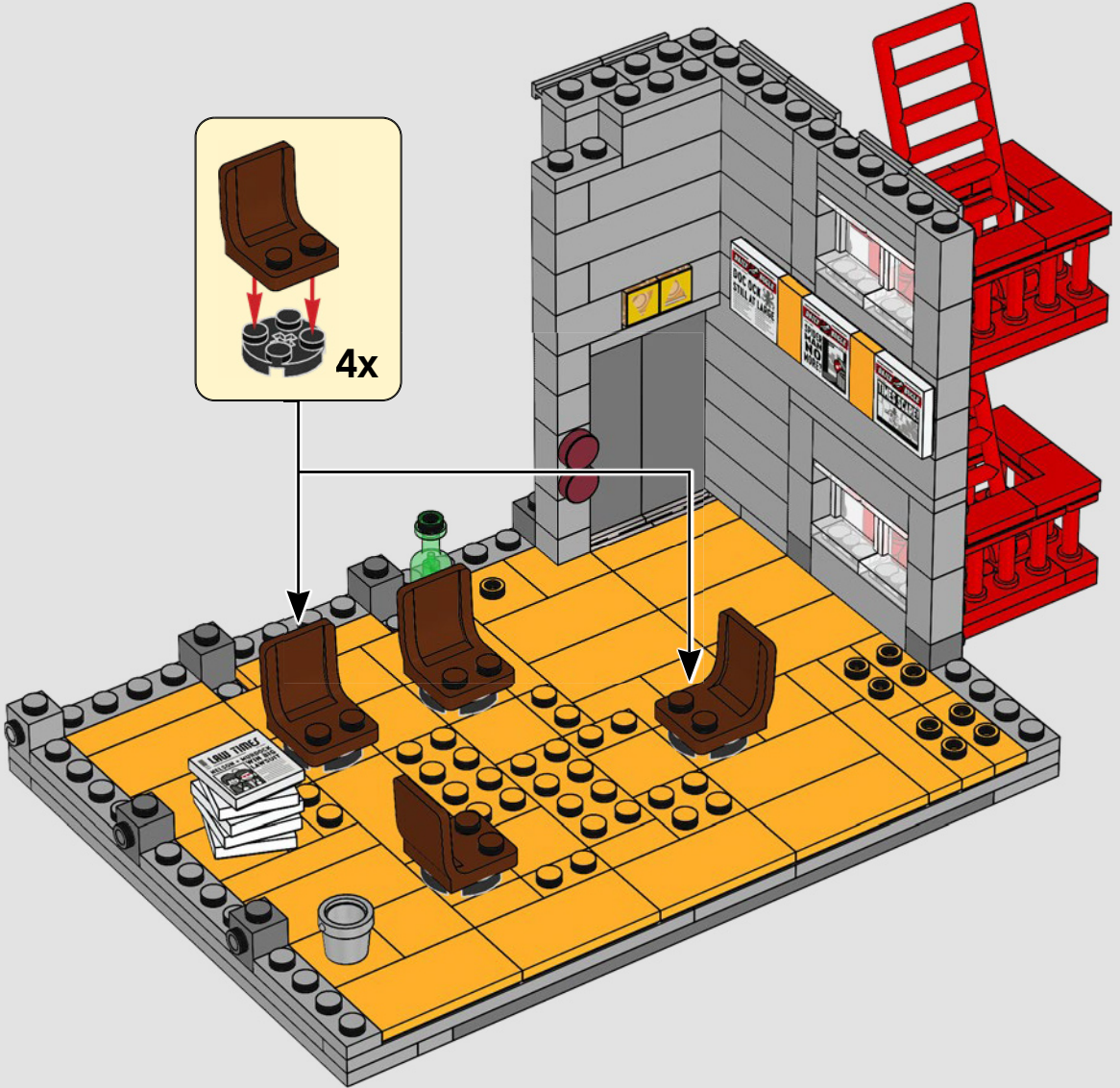





12x



6x

# 205

1

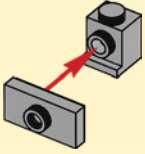

2

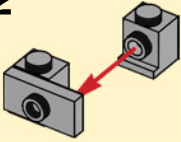

3



4

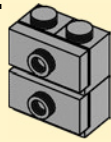

3x

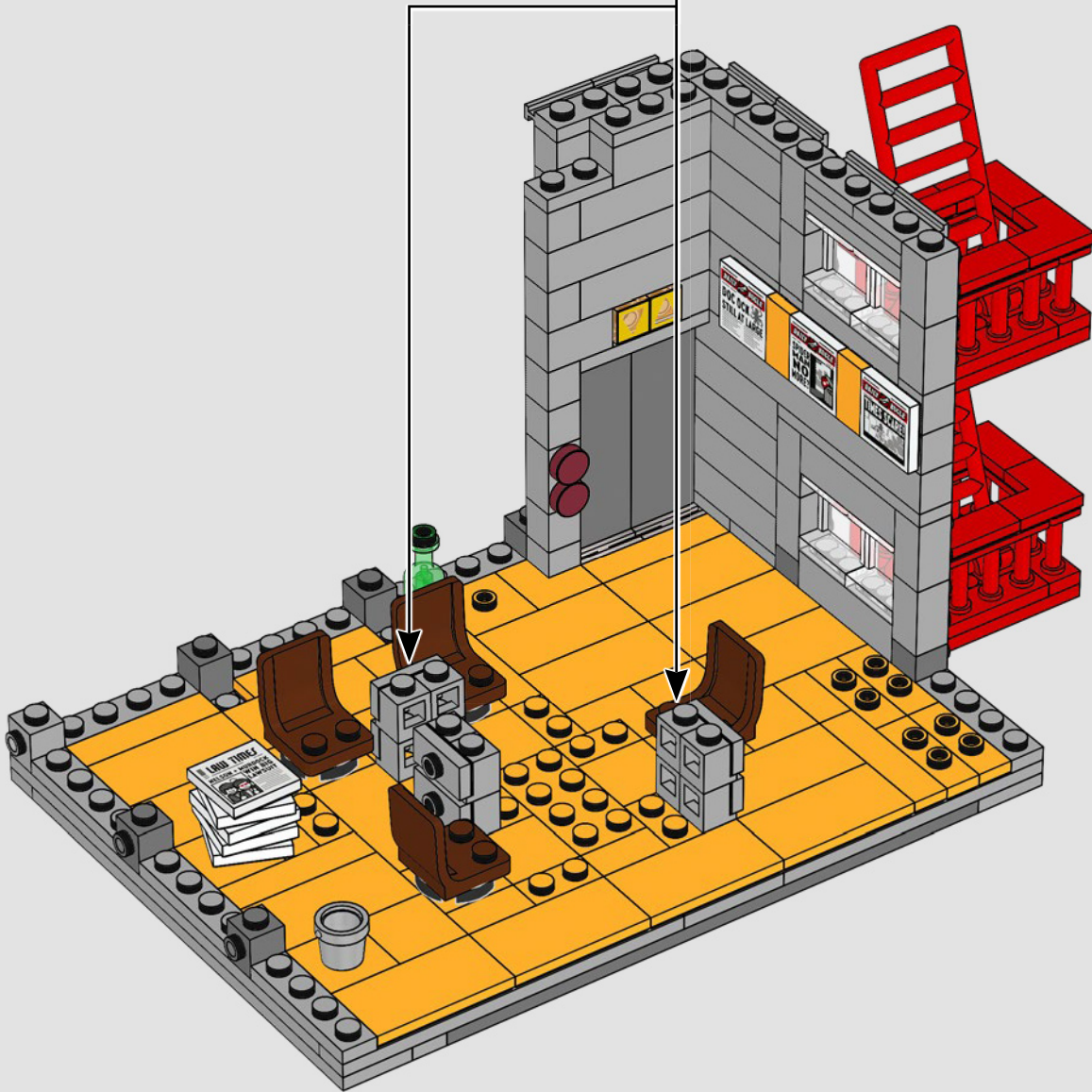

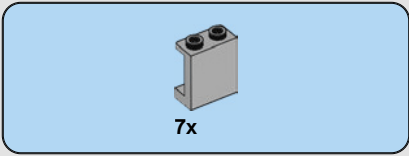

206

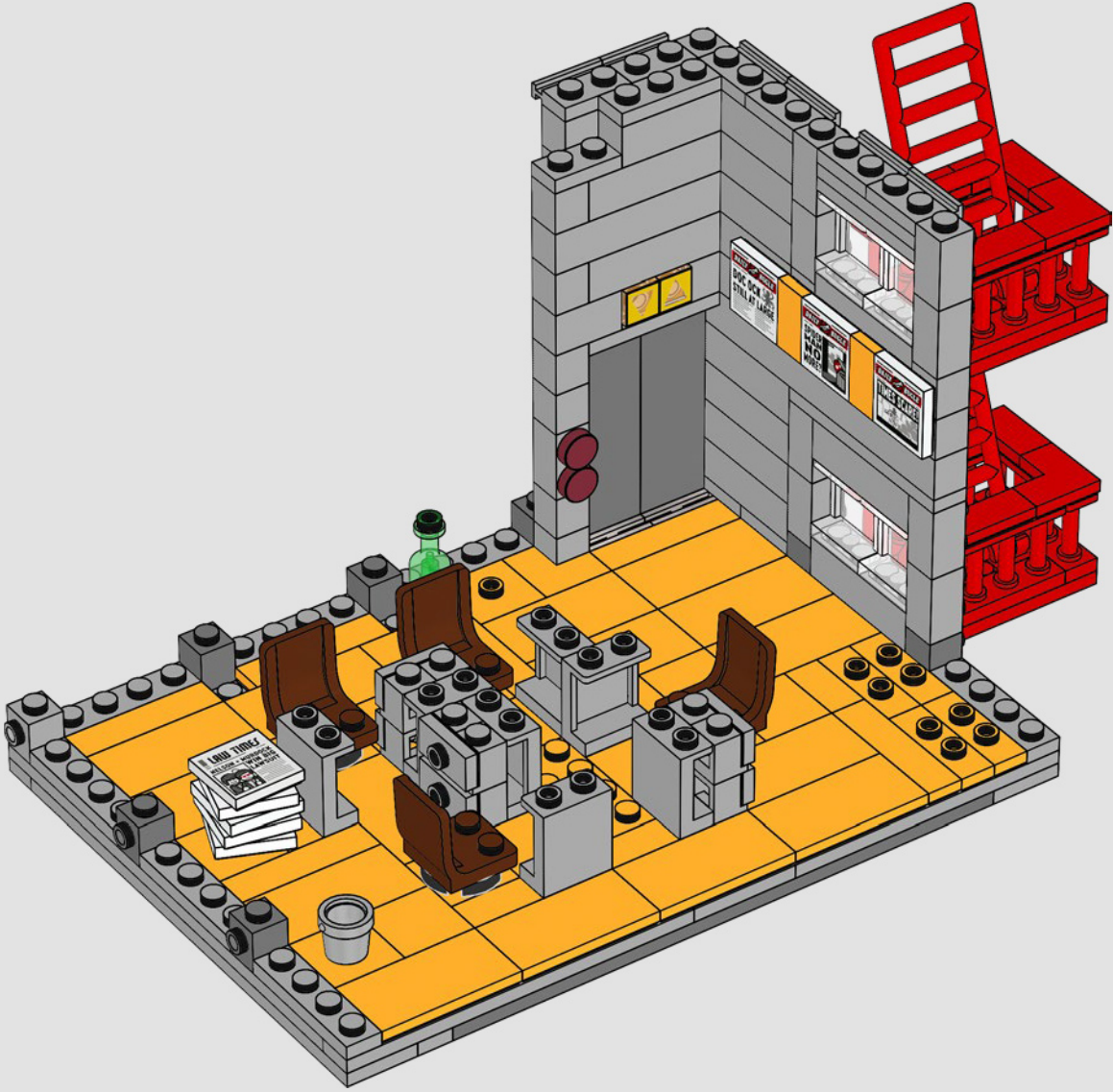



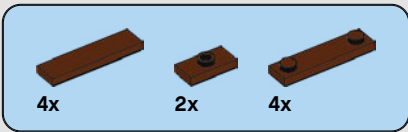

# 207

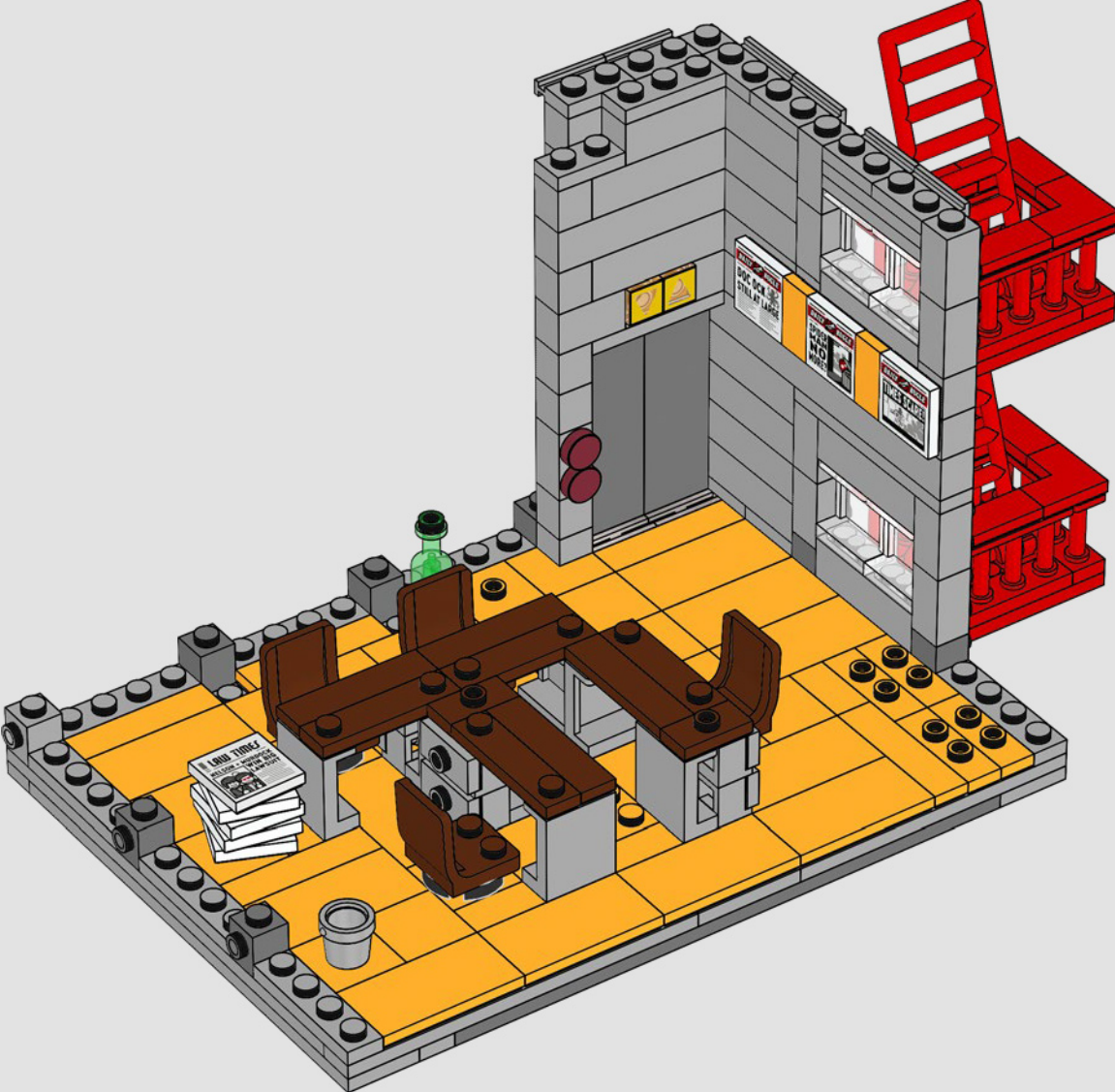

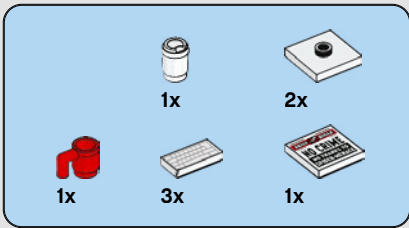

208

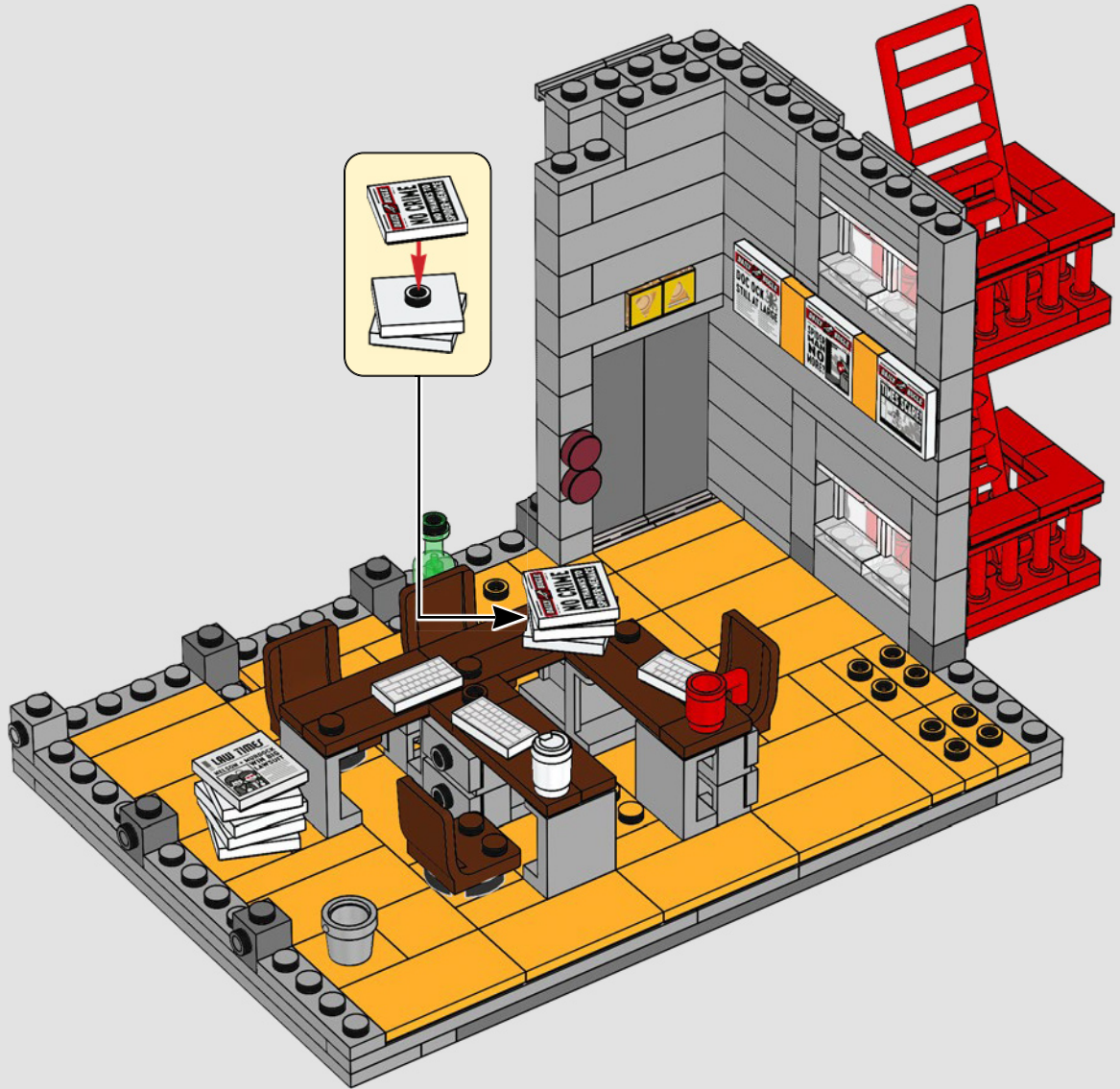



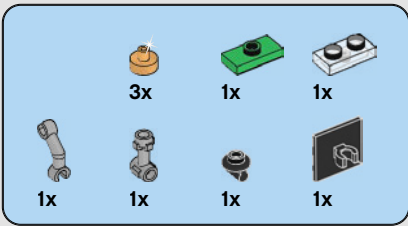

209

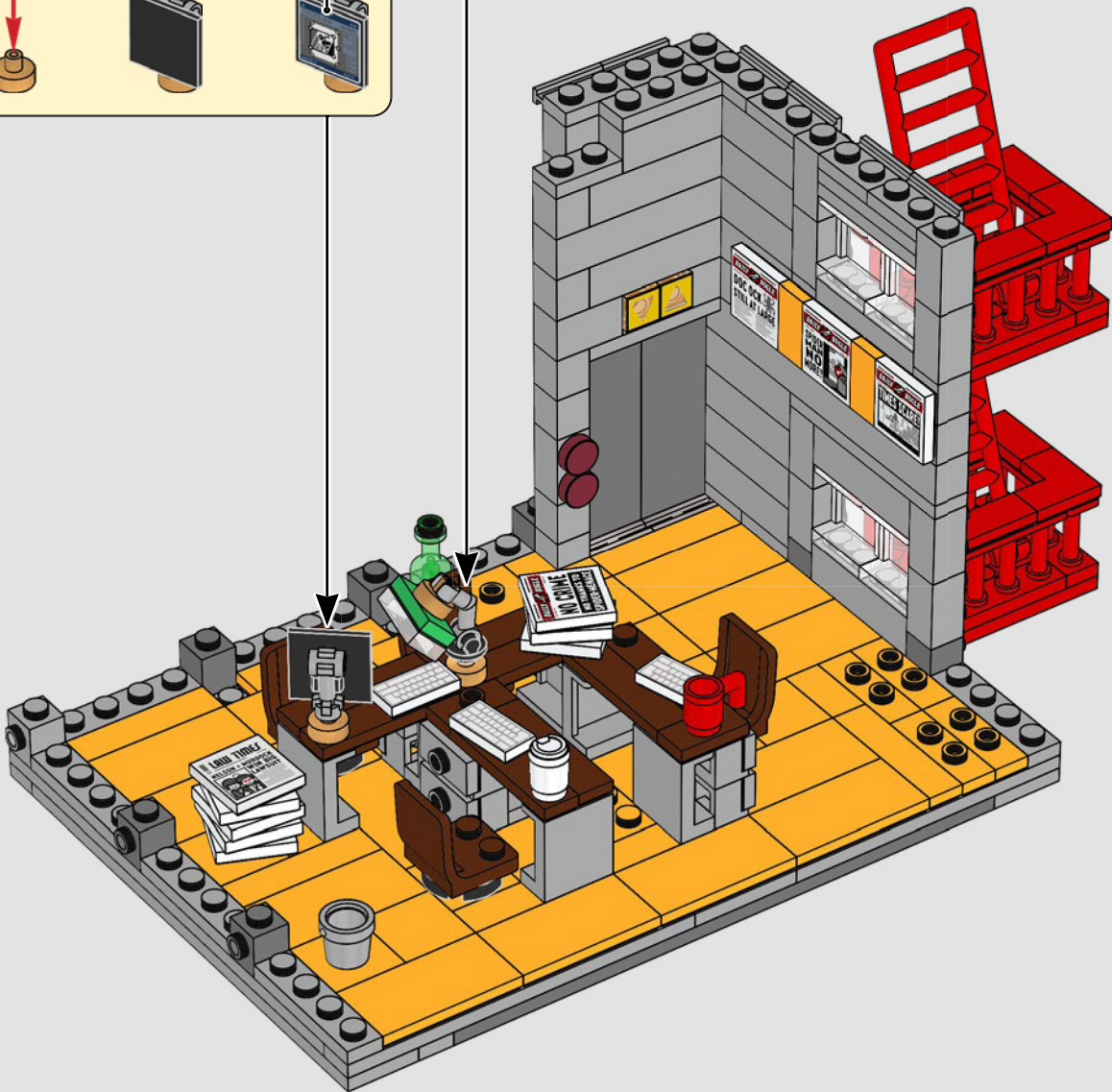
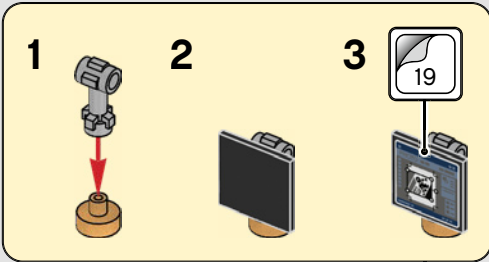
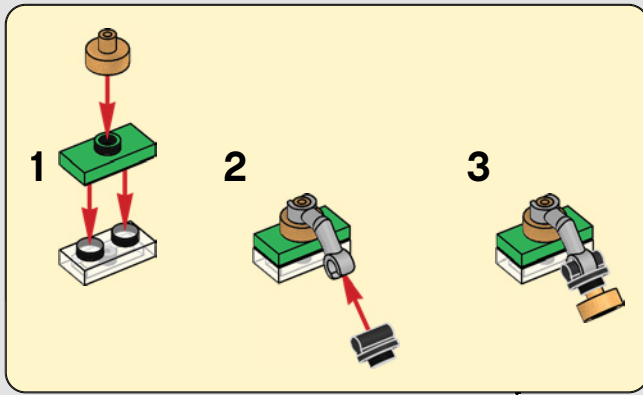

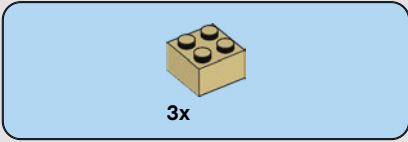
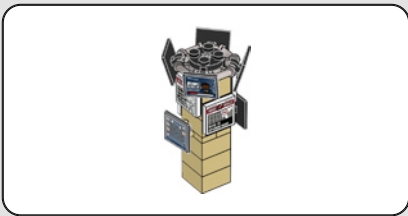

**210**

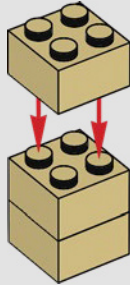

**211**

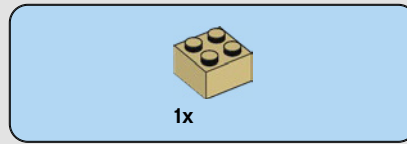
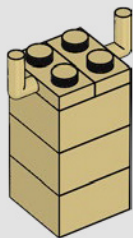

**212**

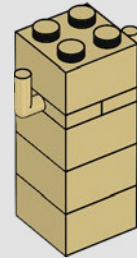

**213**

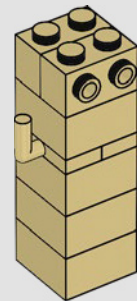





2x

# 214

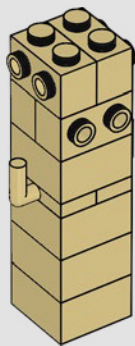

1x

1x

1x

1x

# 215

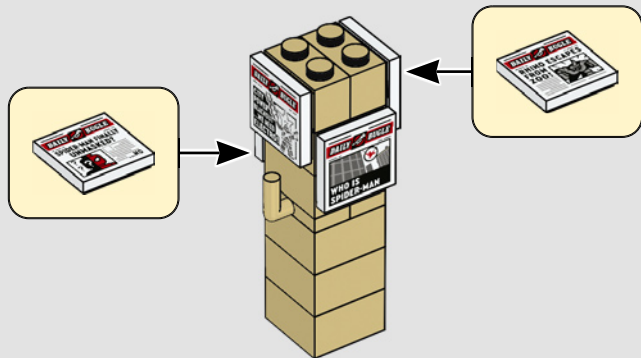

1x

# 216



1x



1x

# 217

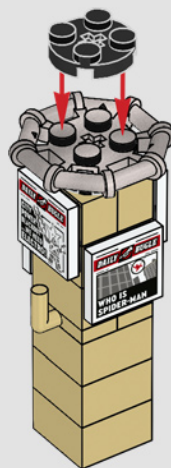

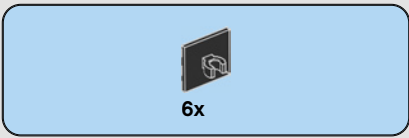

218



219

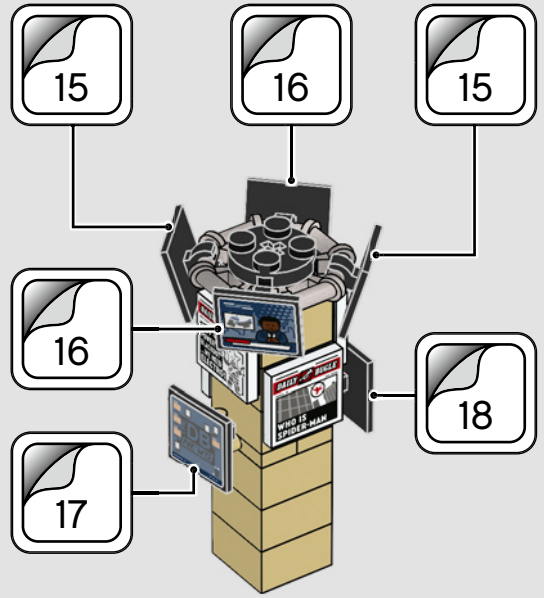

220

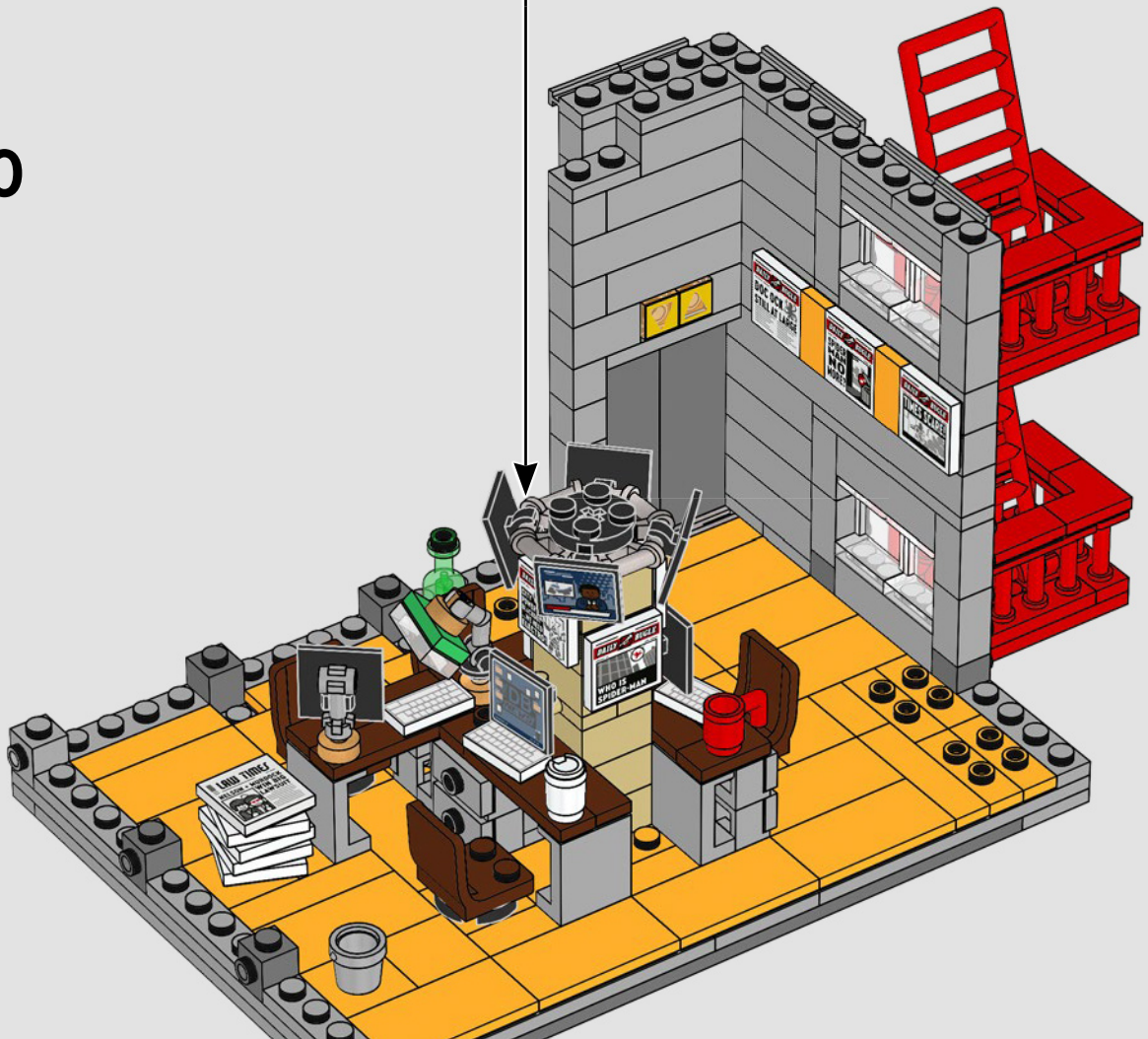





6x



3x

# 221

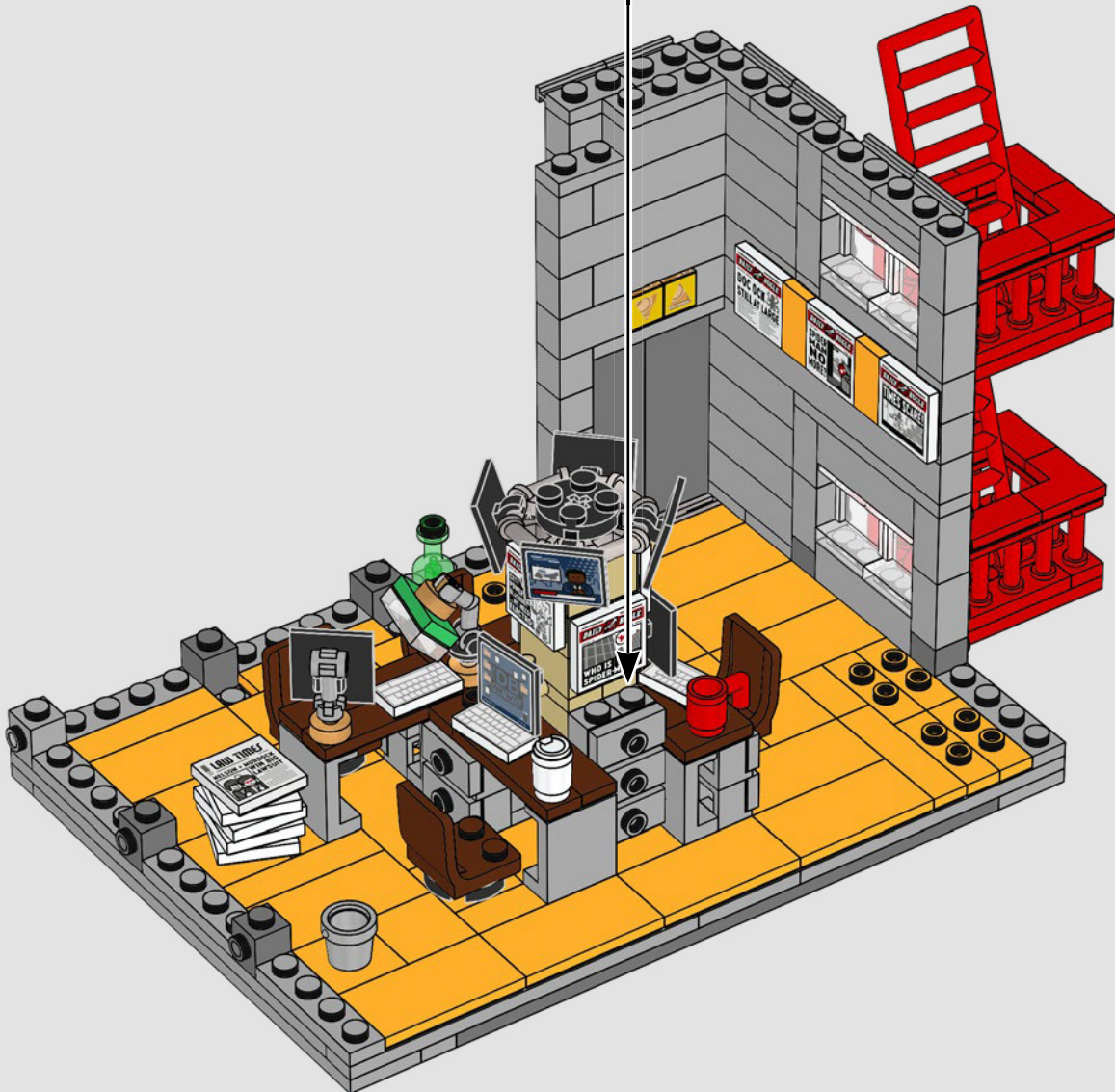
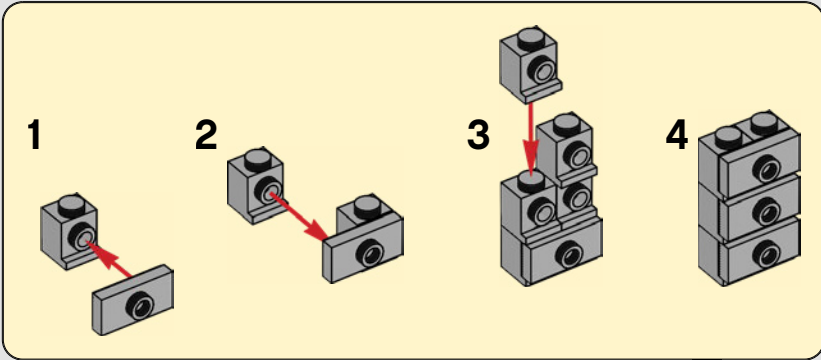

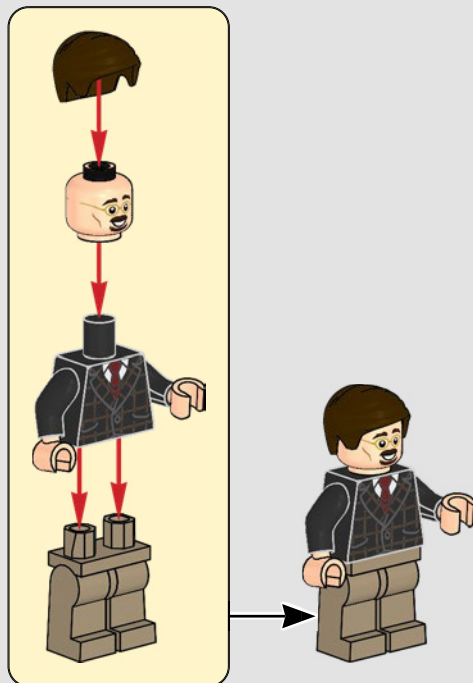
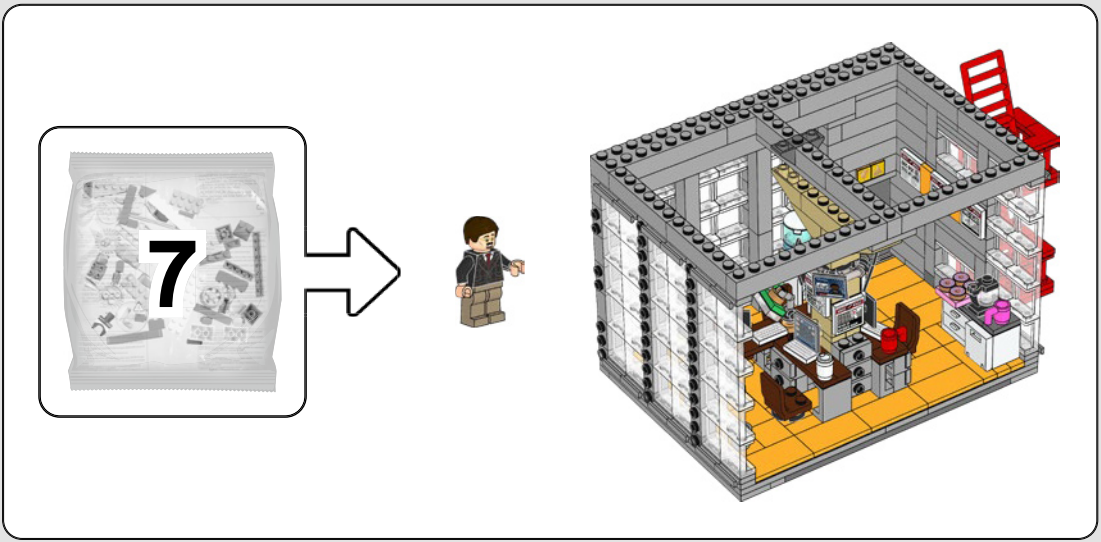





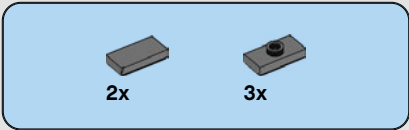

# 223

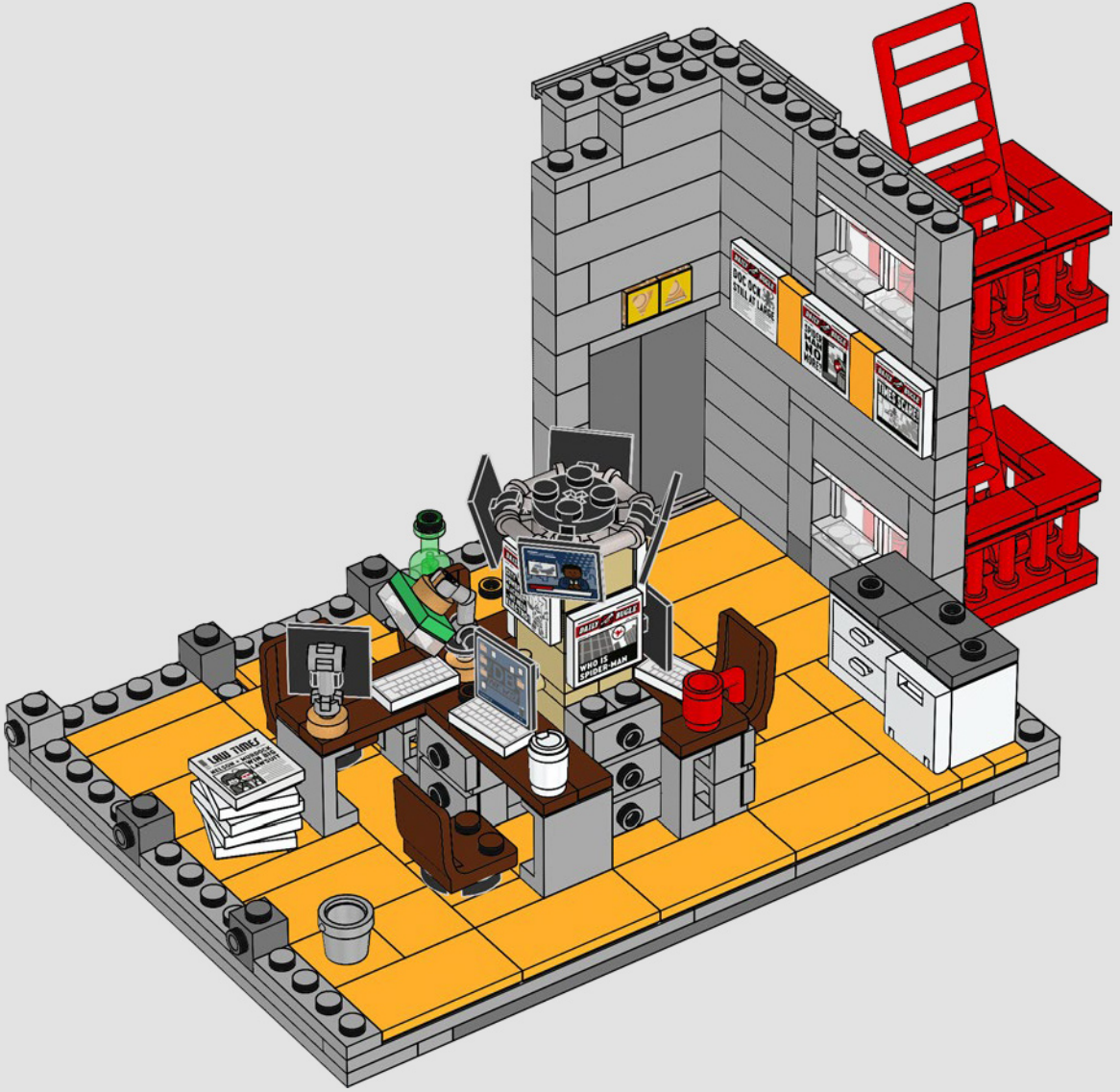



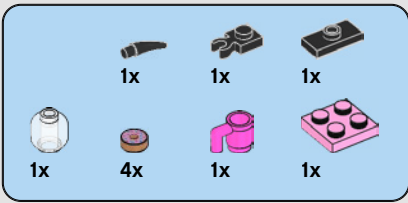

224

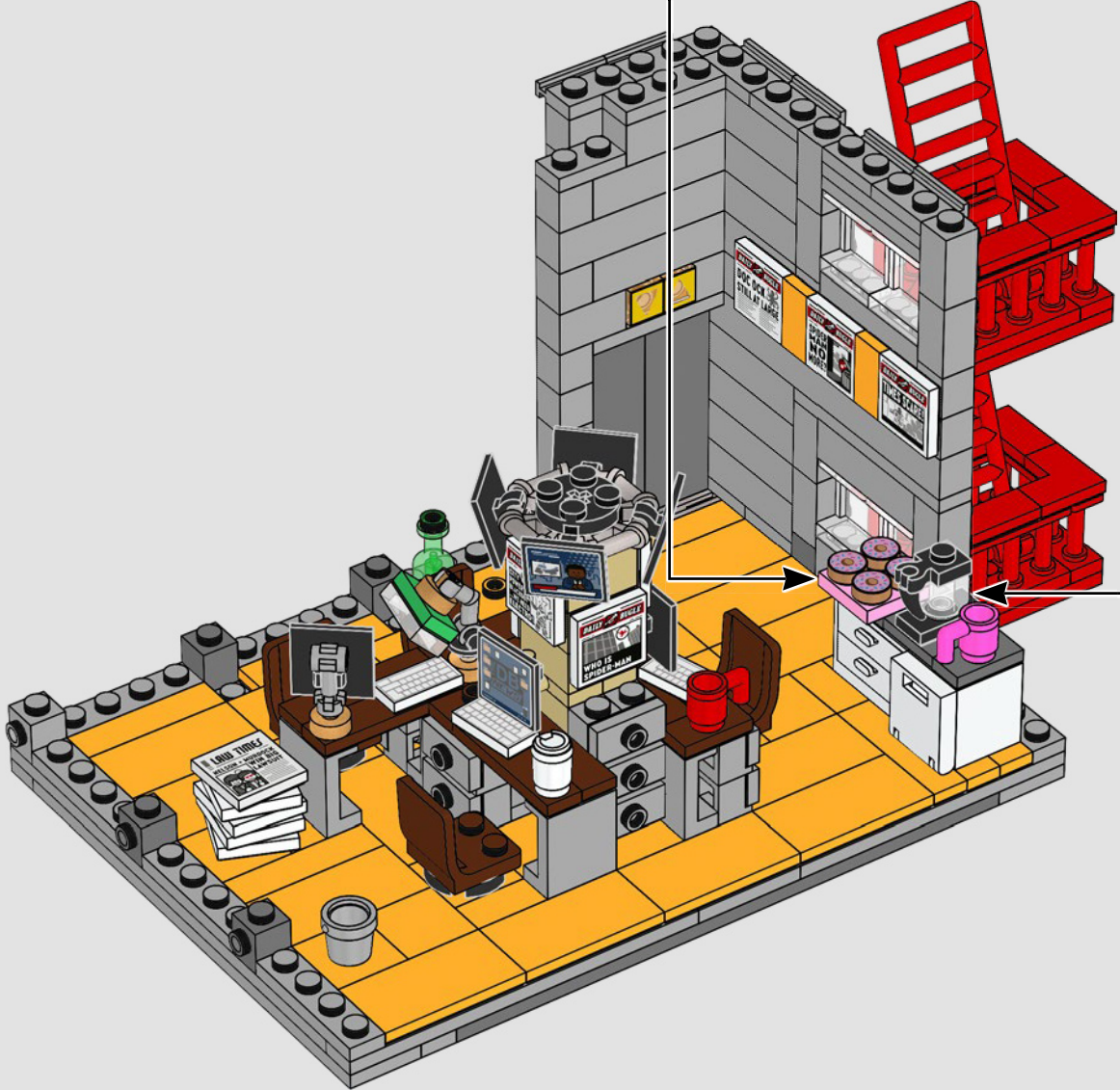
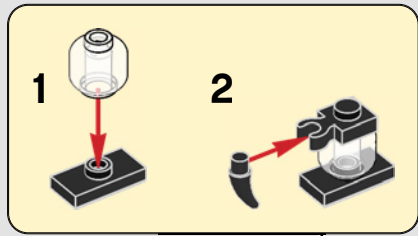
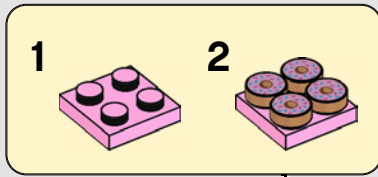

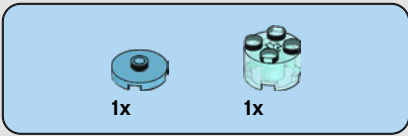

225

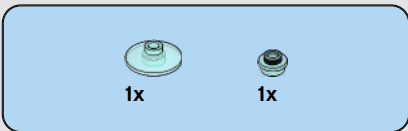
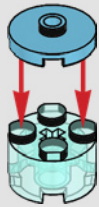

226

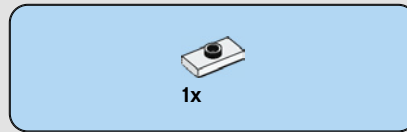
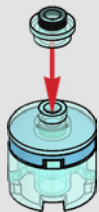

227

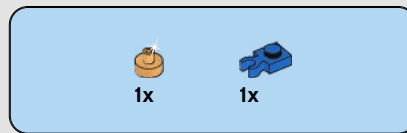

228



229

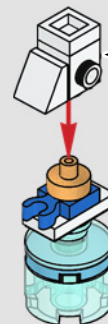
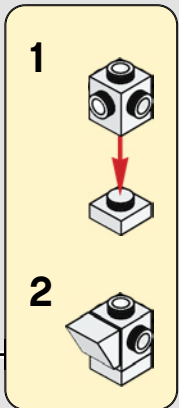





1x

230



2x

231



232

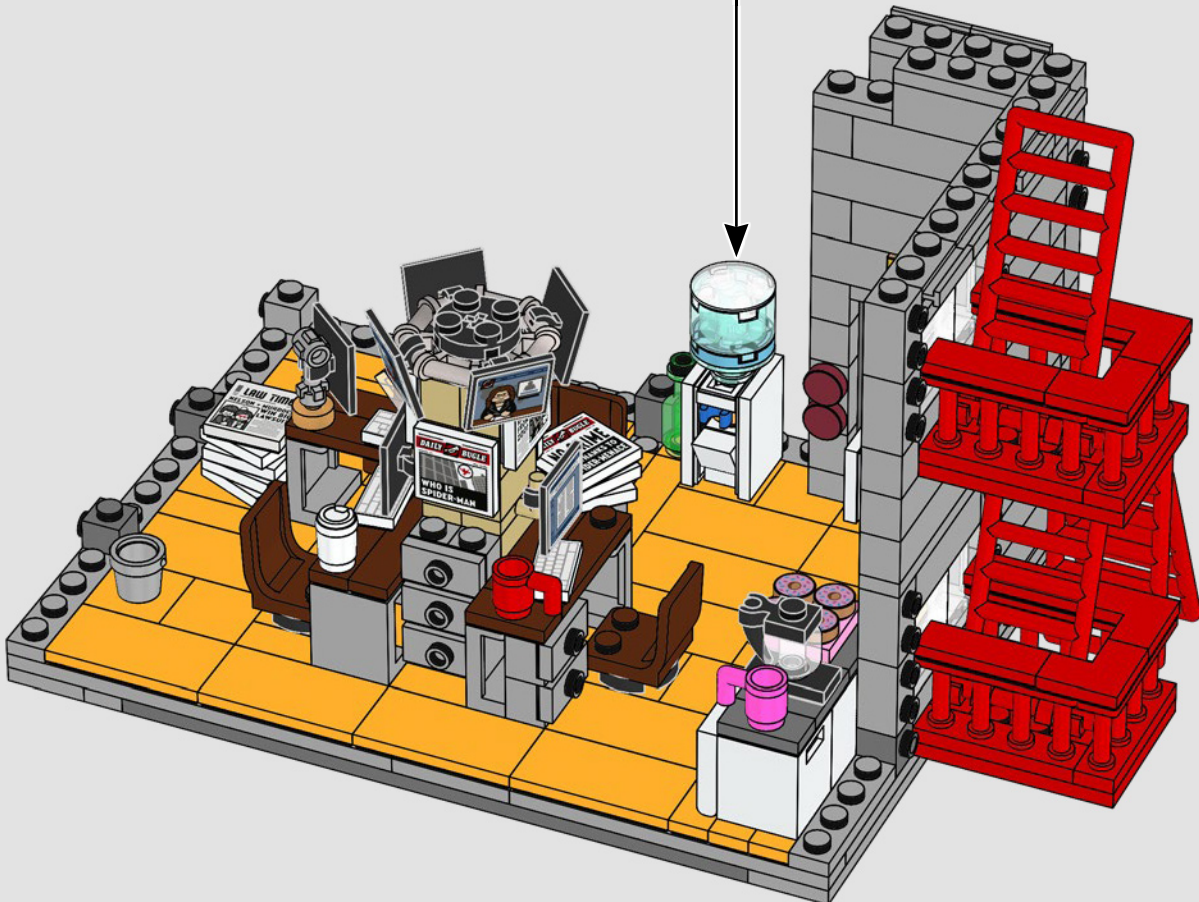



30x

233



5x

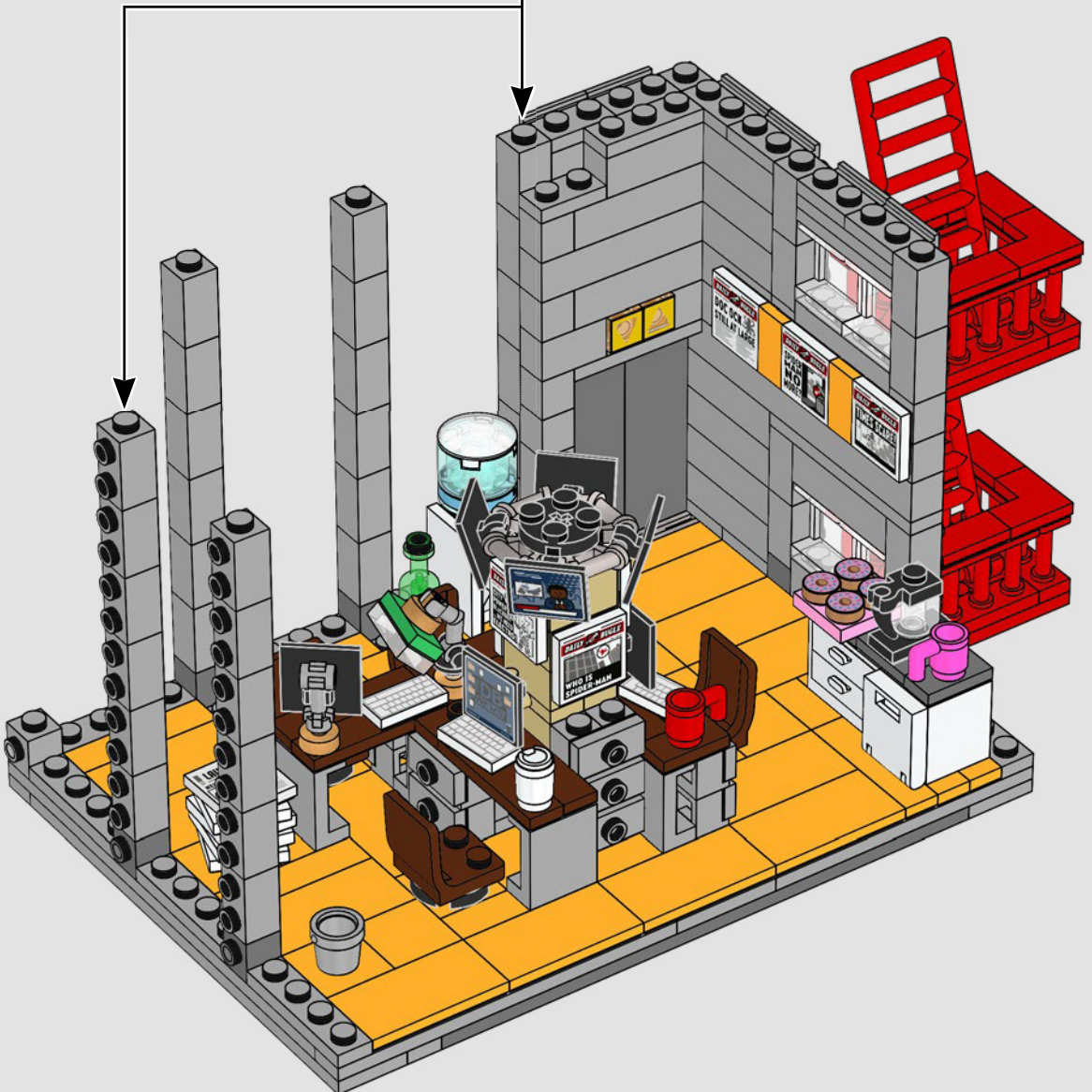



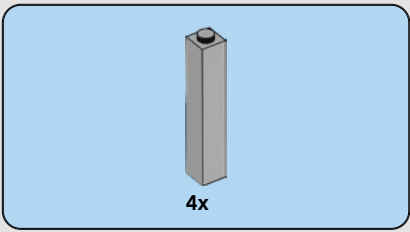

234

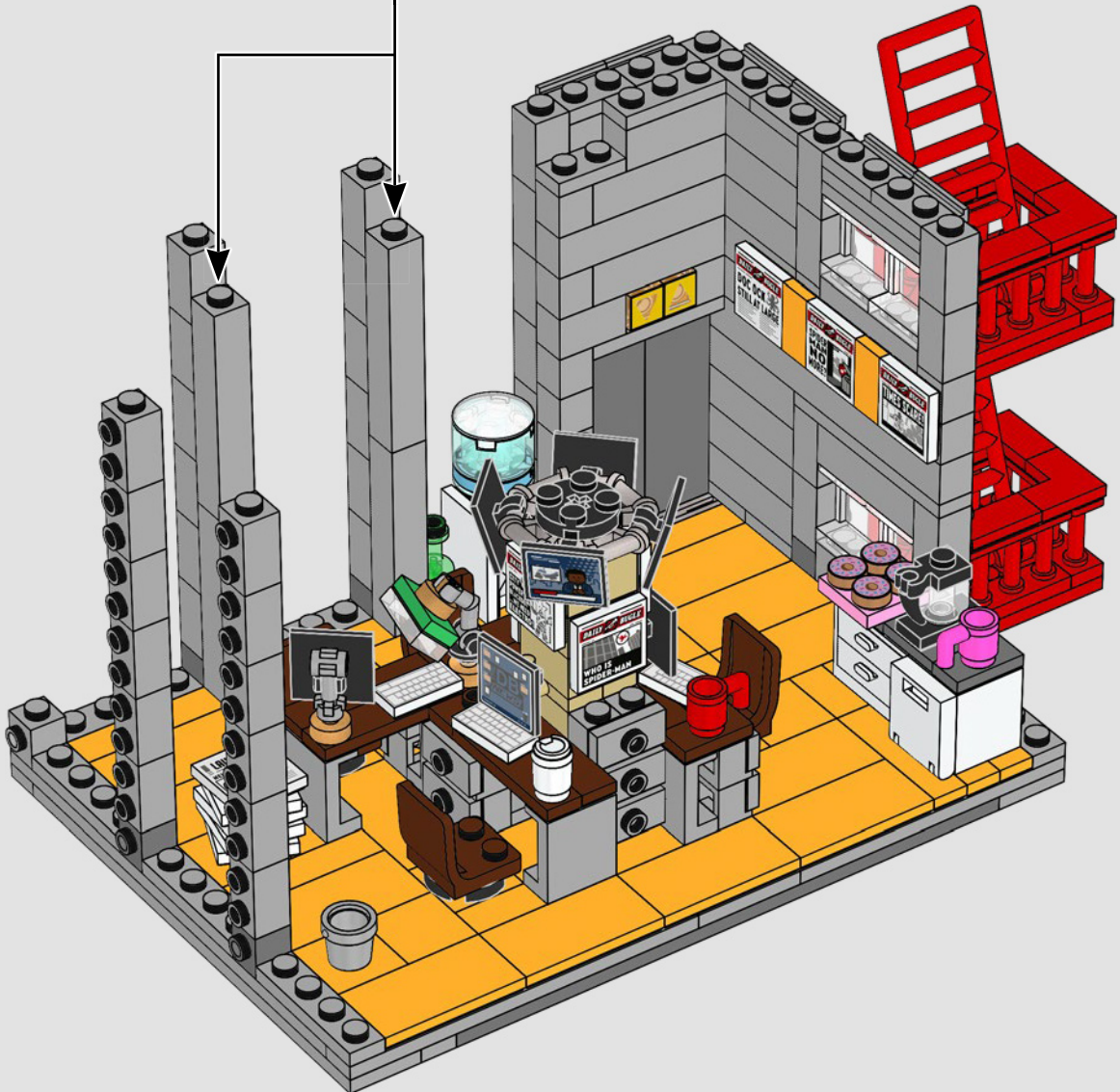
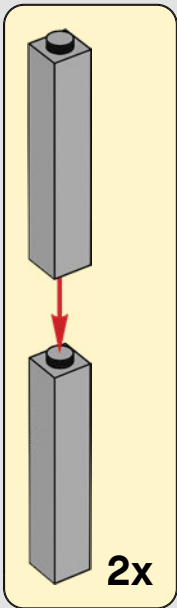

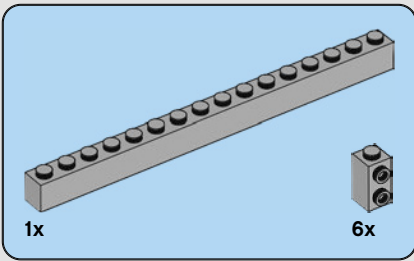

235

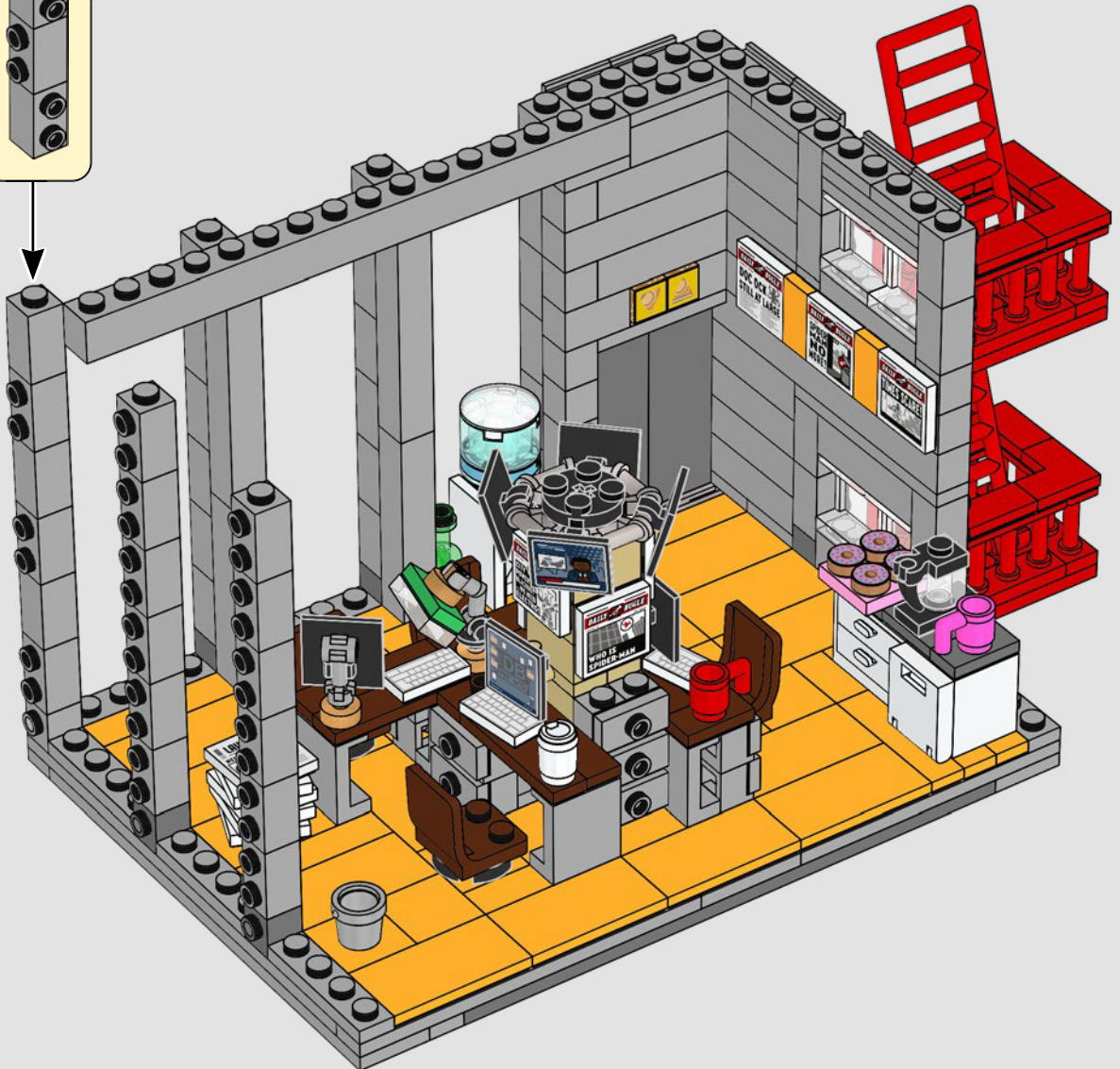
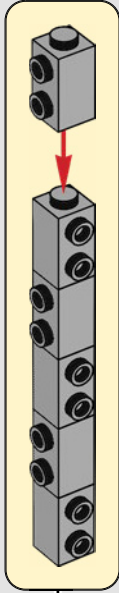



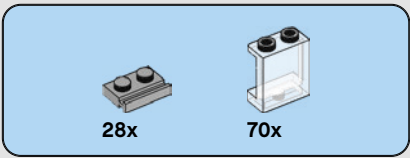

236

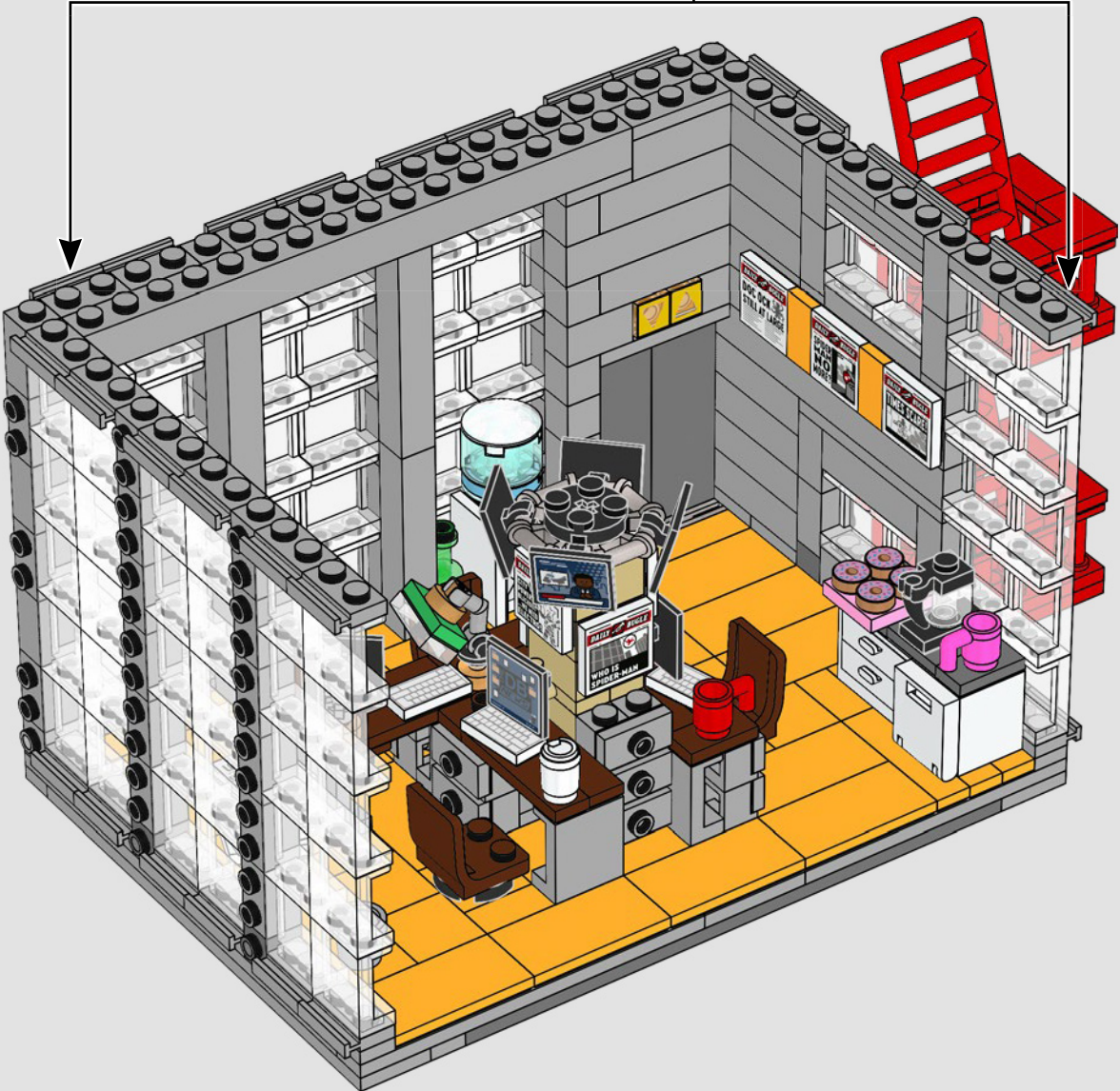
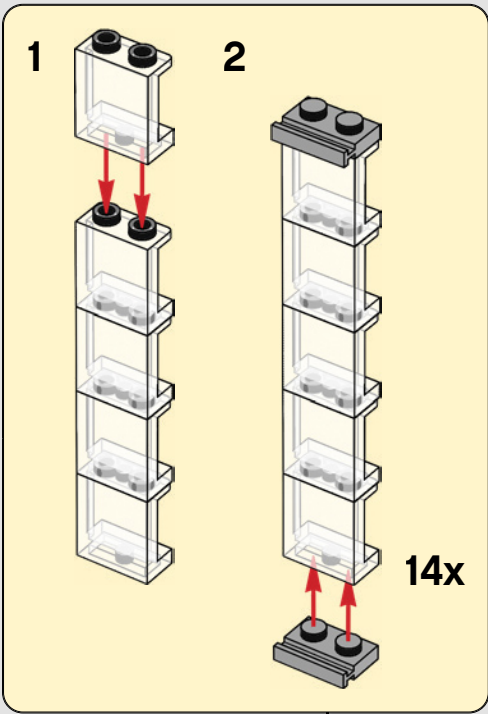

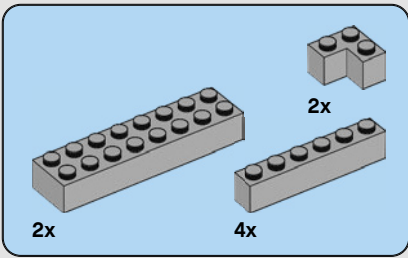

237





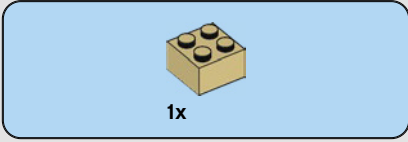
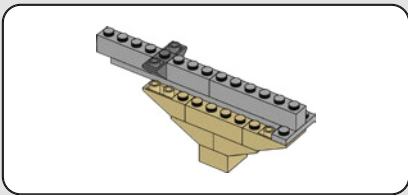

**238**

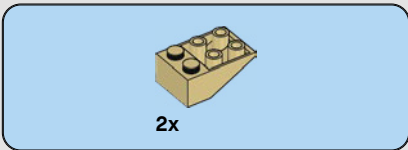
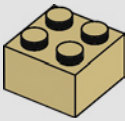

**239**

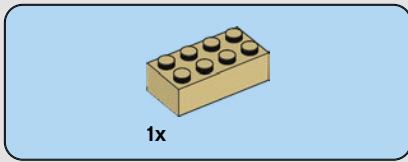
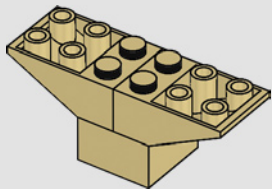

**240**

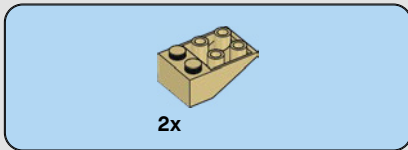
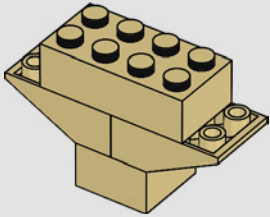

**241**

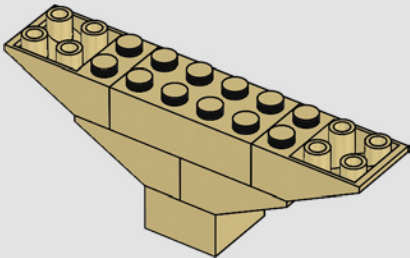

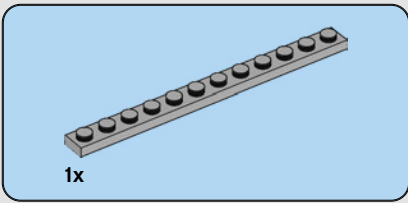

**242**

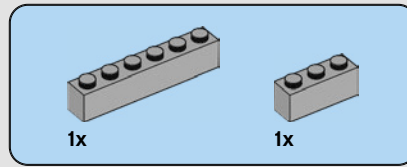
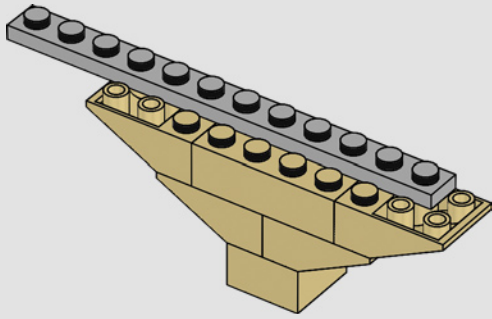

**244**

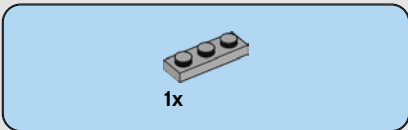
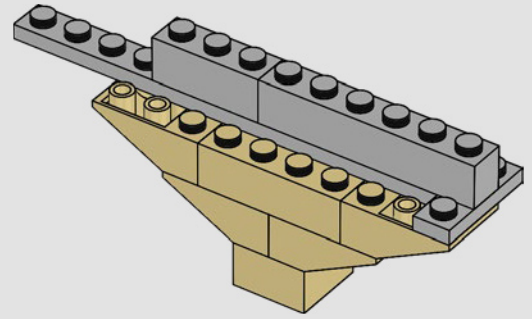

**243**

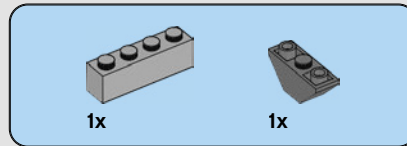
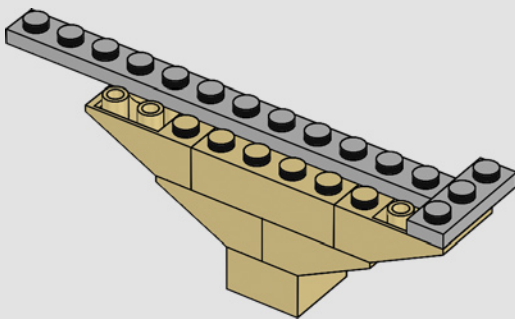

**245**

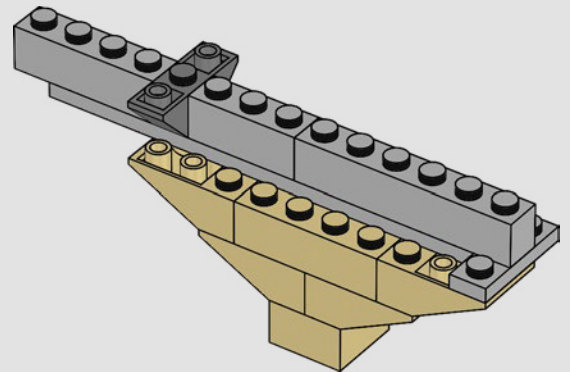





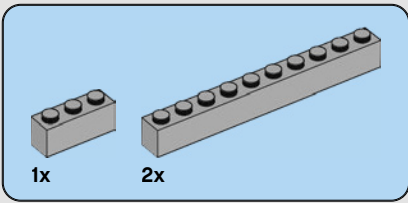

247





1x

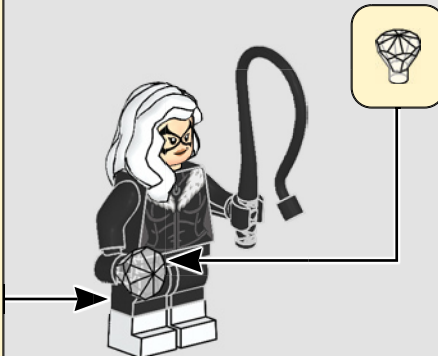
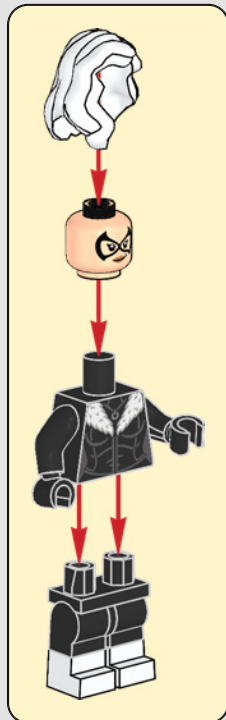
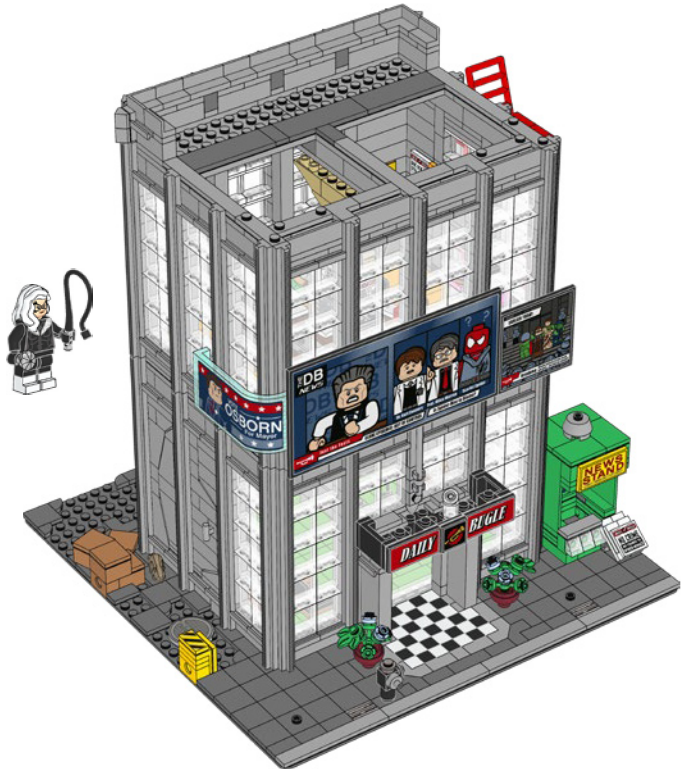
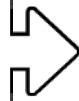



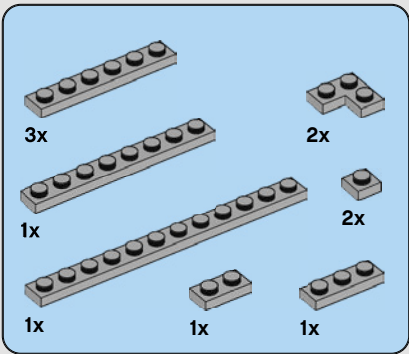

# 248



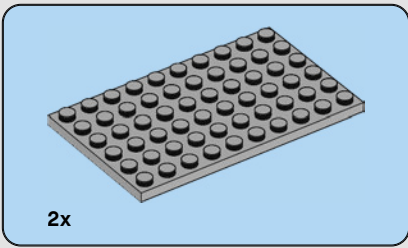

249

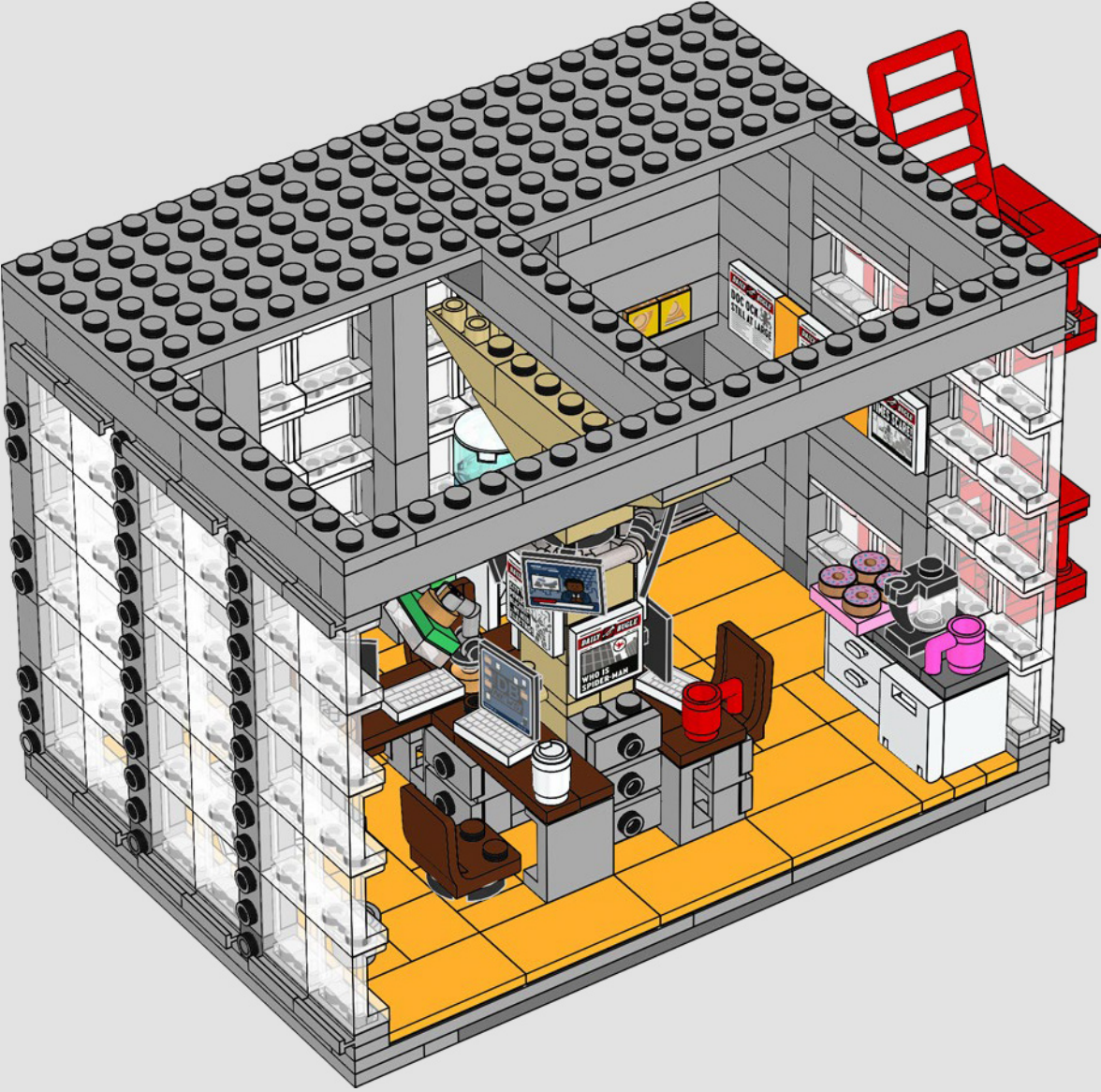



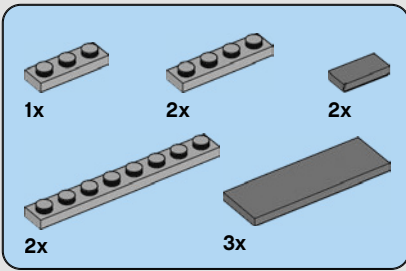

250

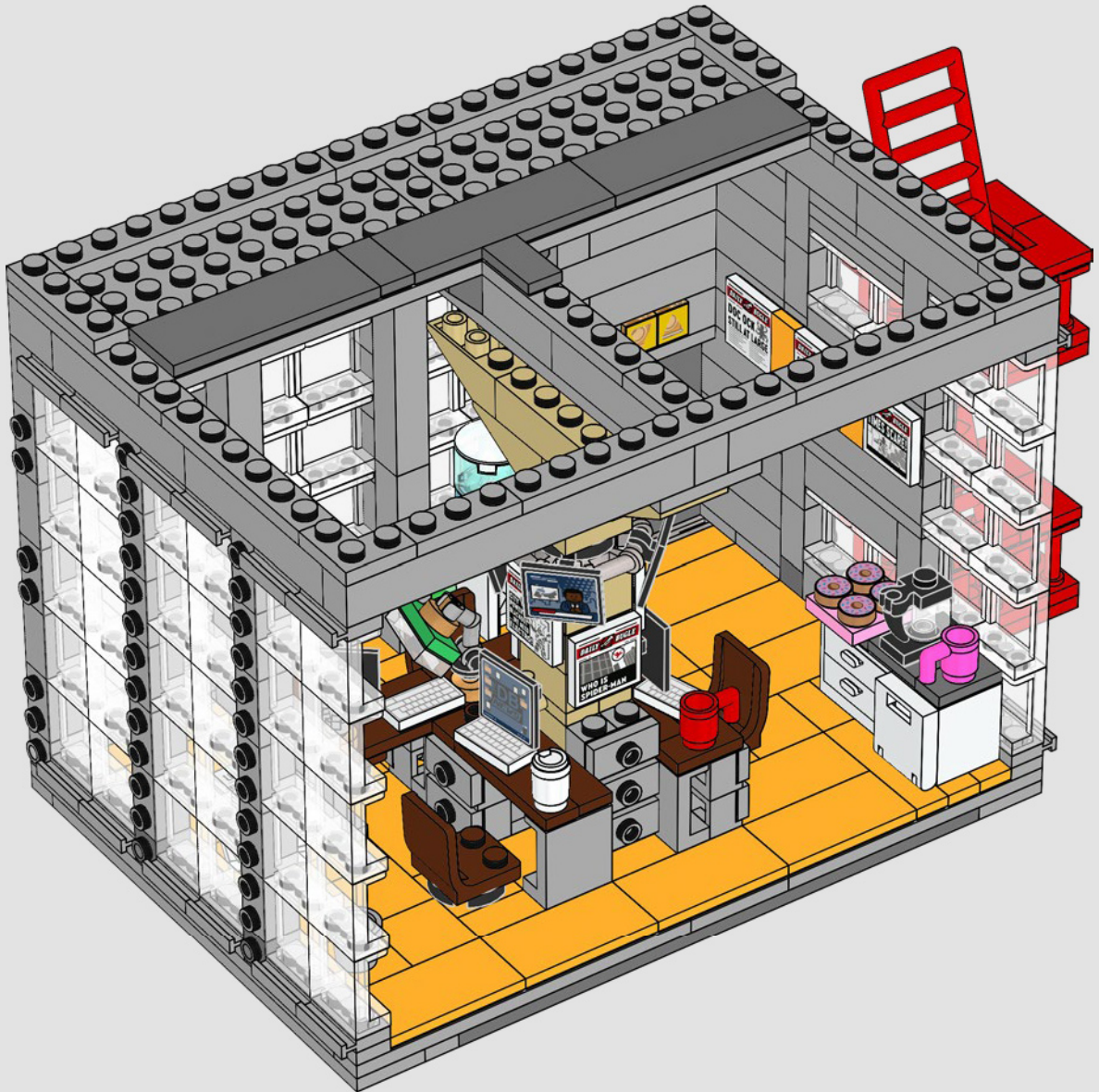



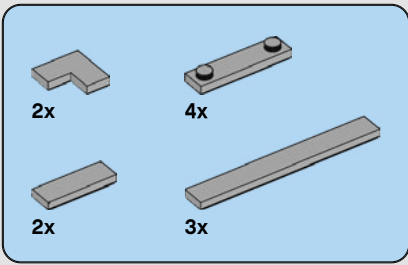

251

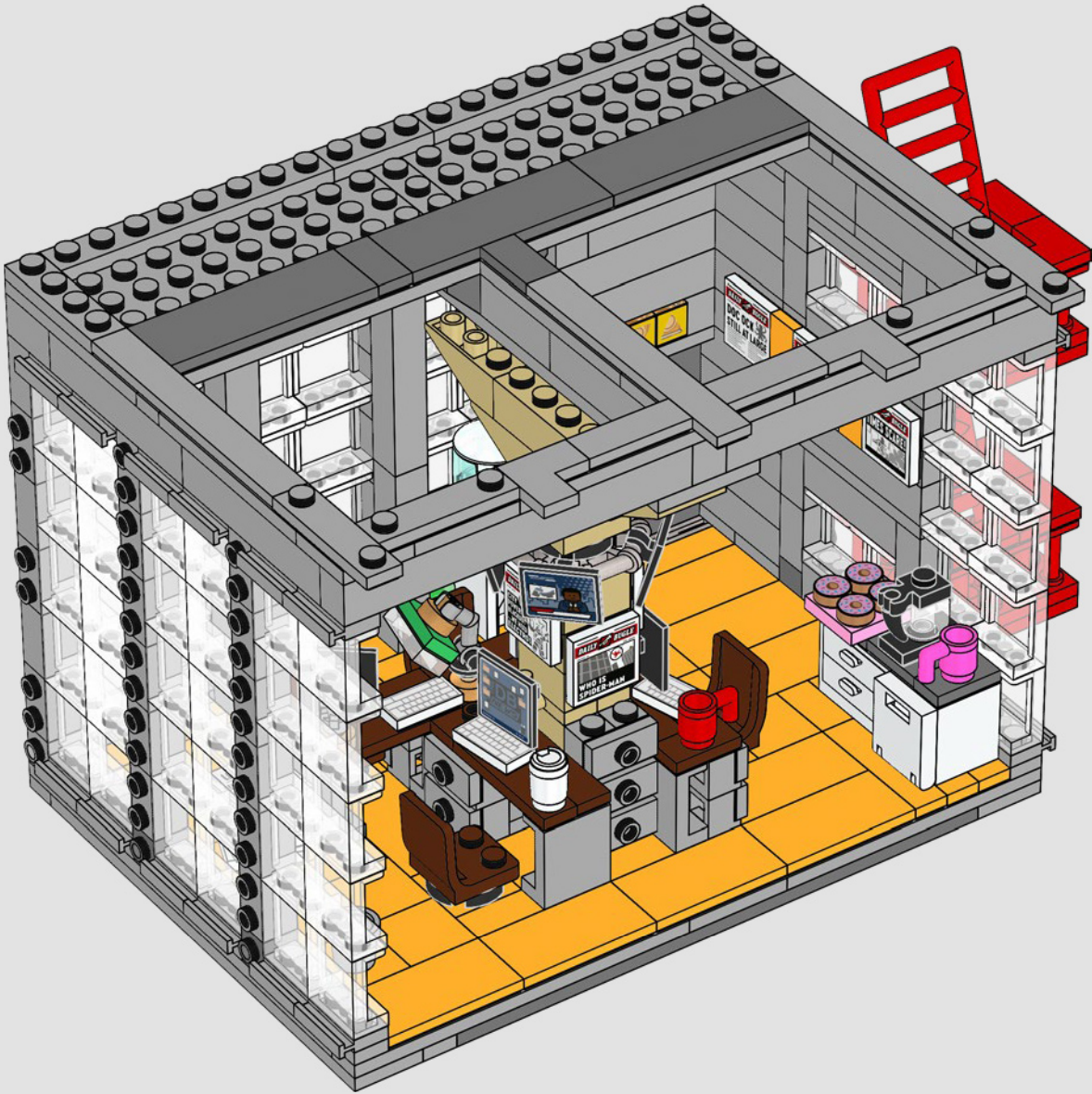

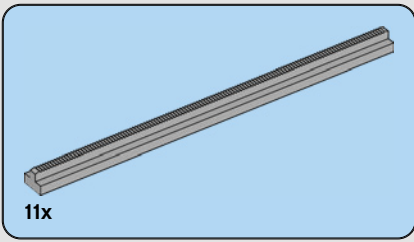

252

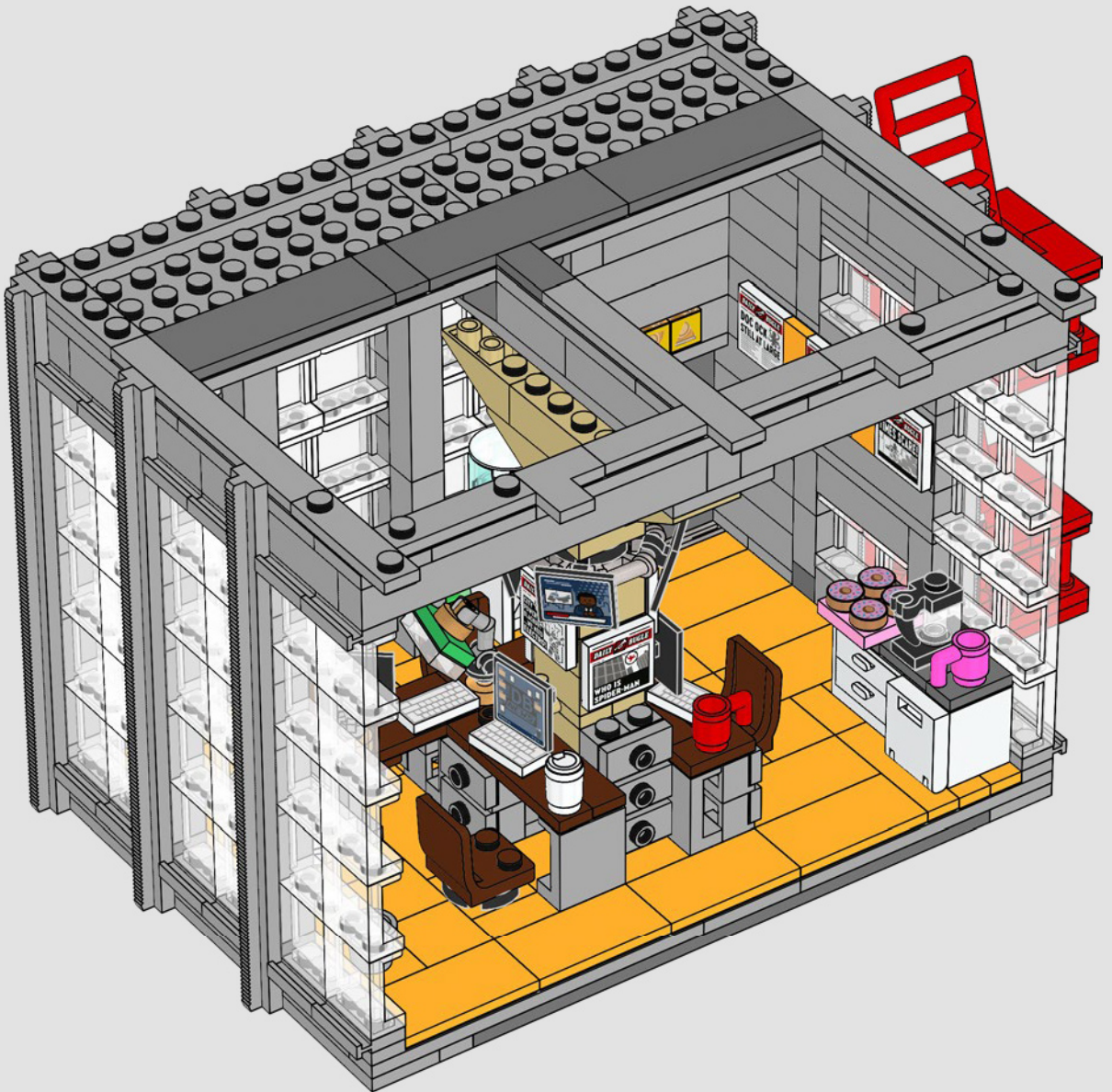



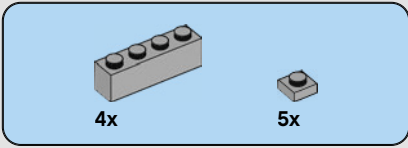

# 253

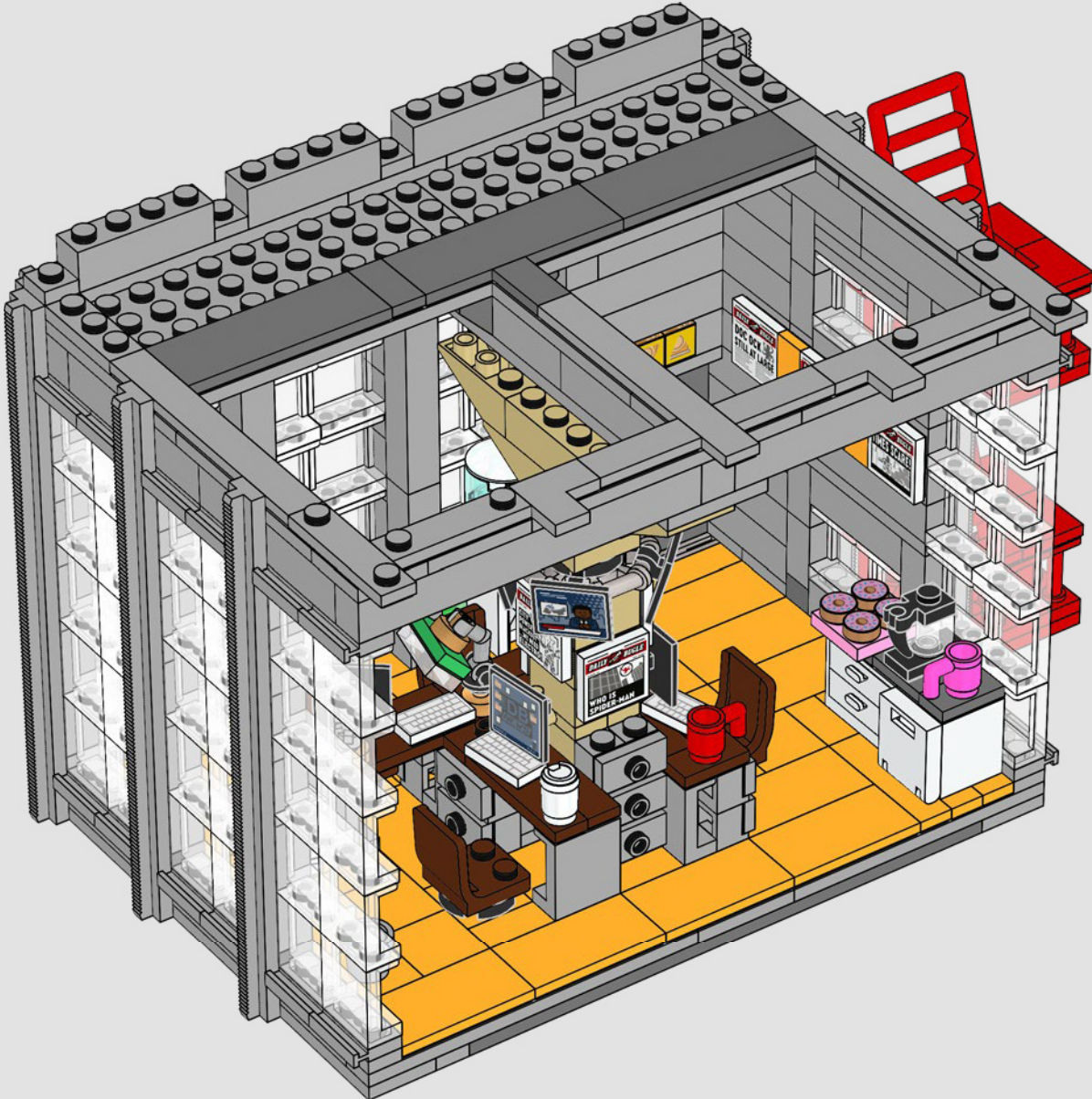

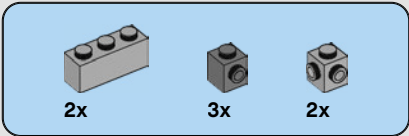

# 254

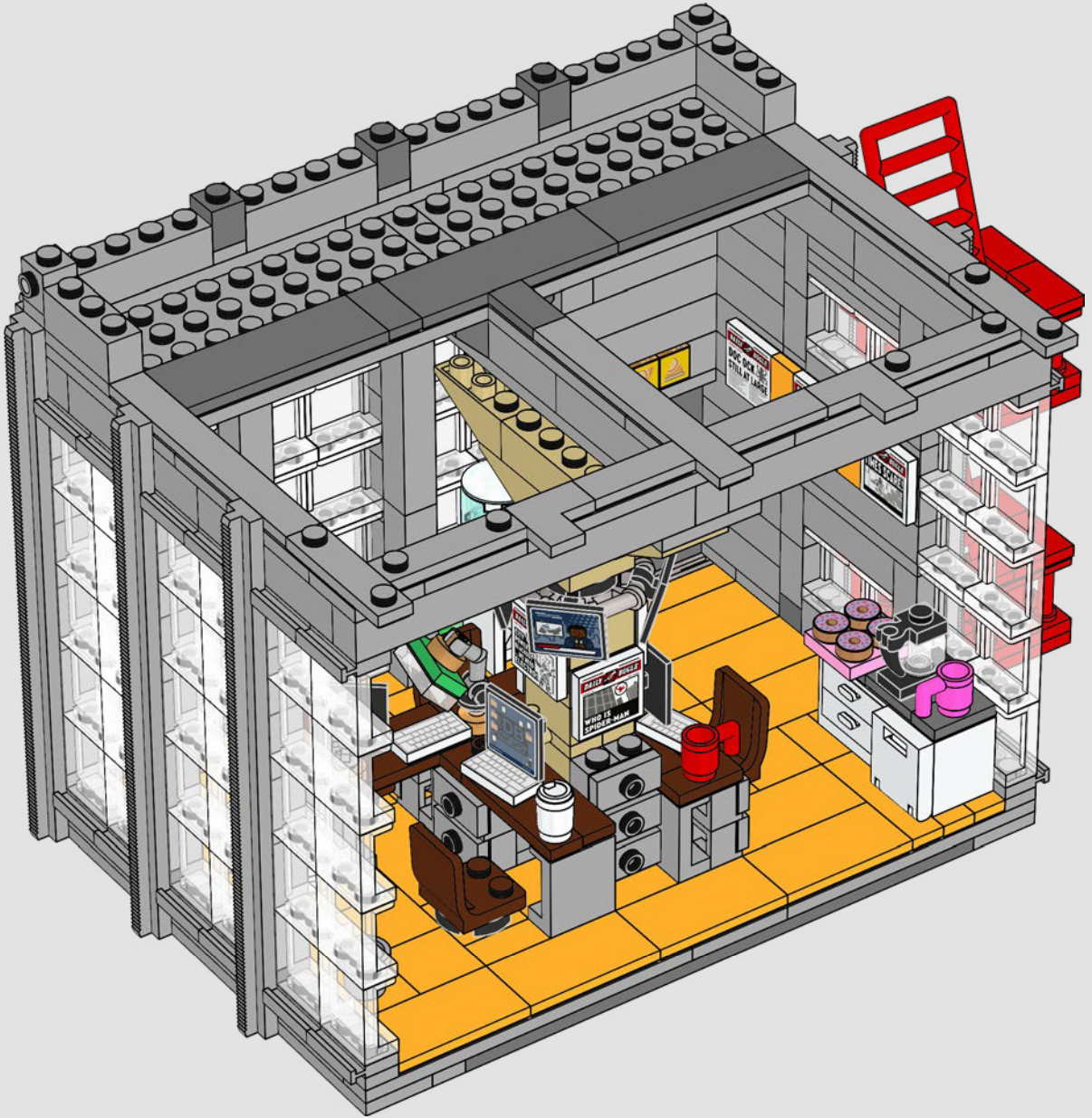





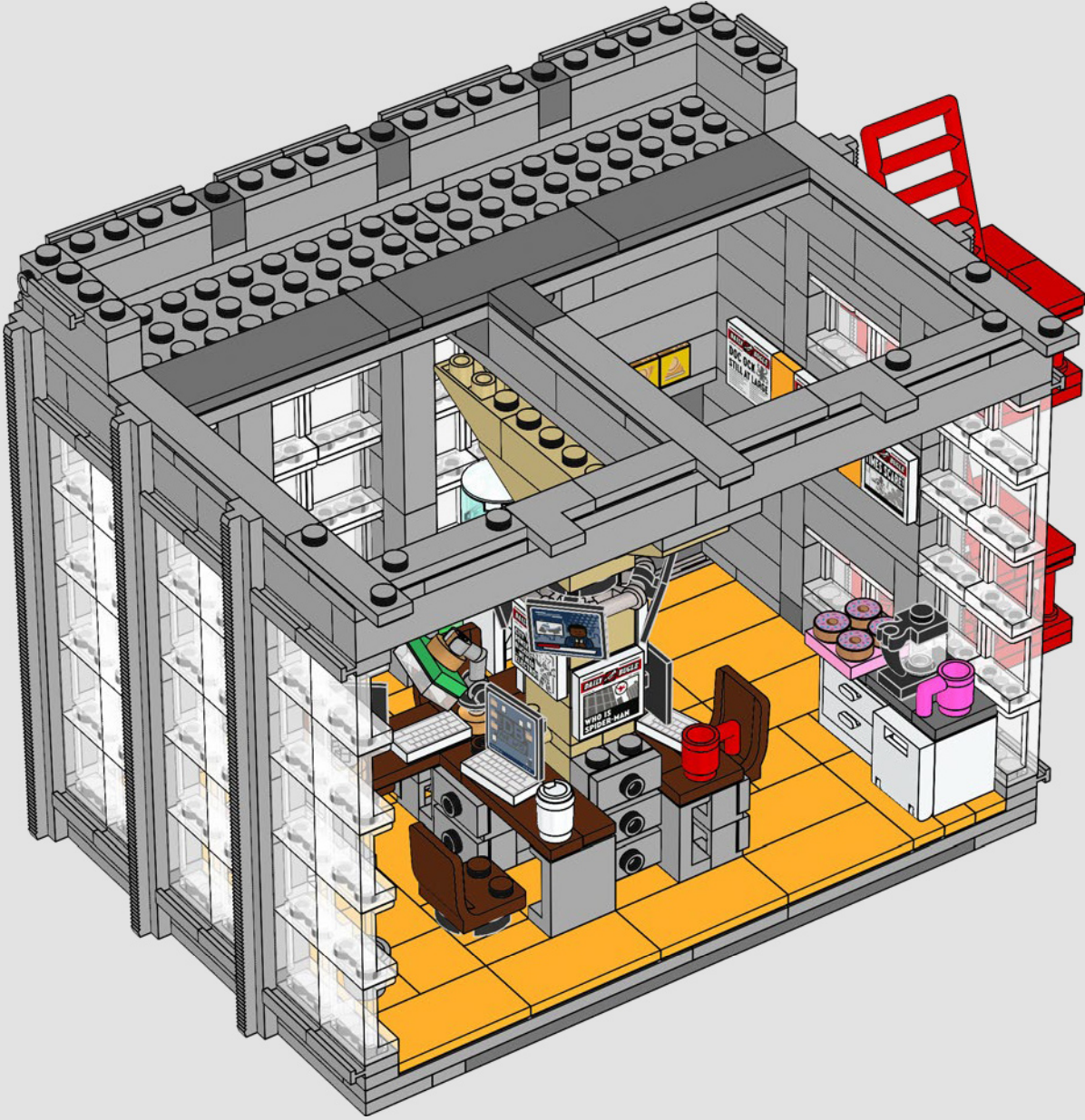

2x      10x

# 255



7x  14x 

1  2  7x

256

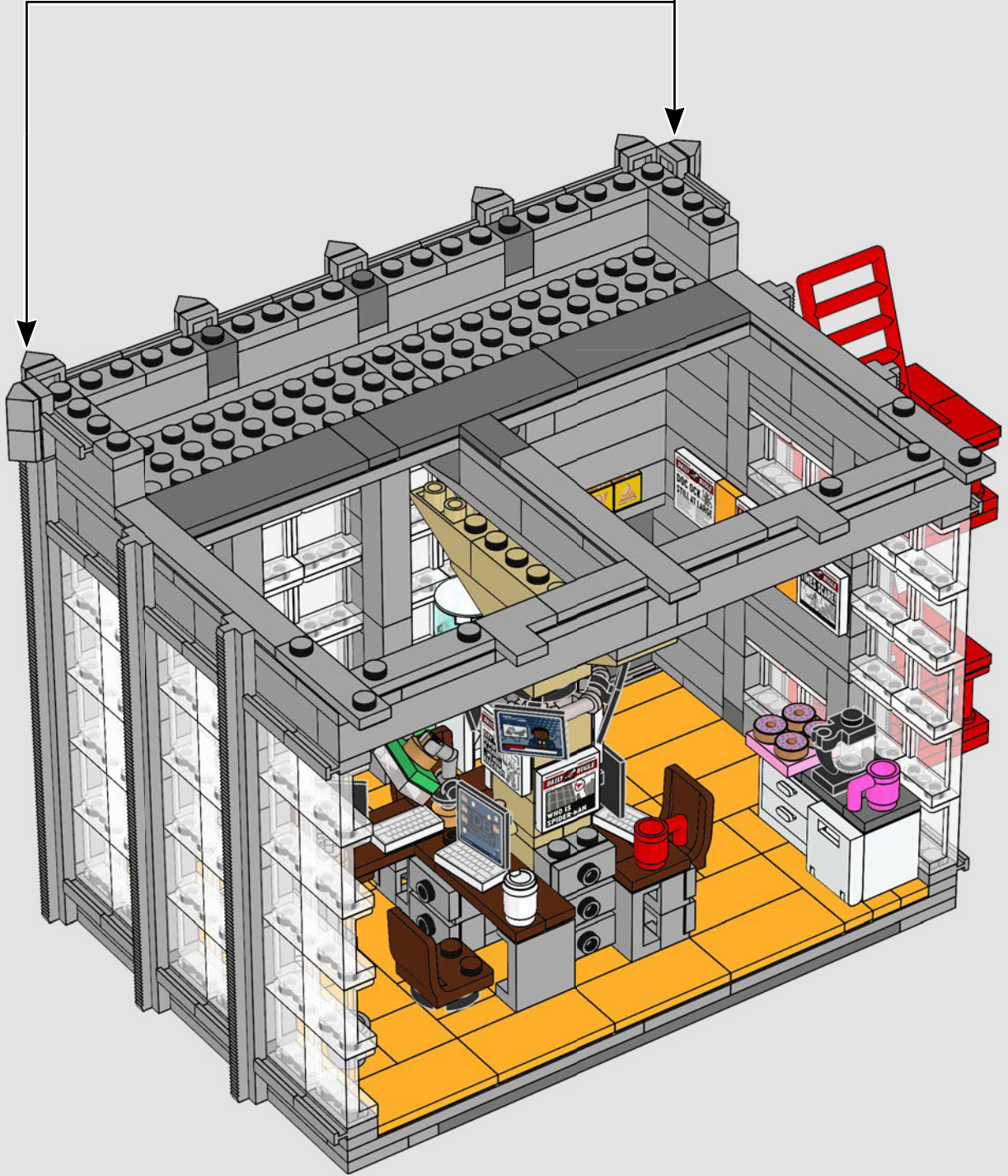



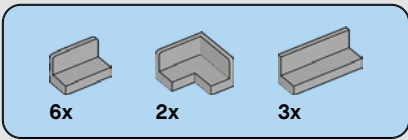

# 257

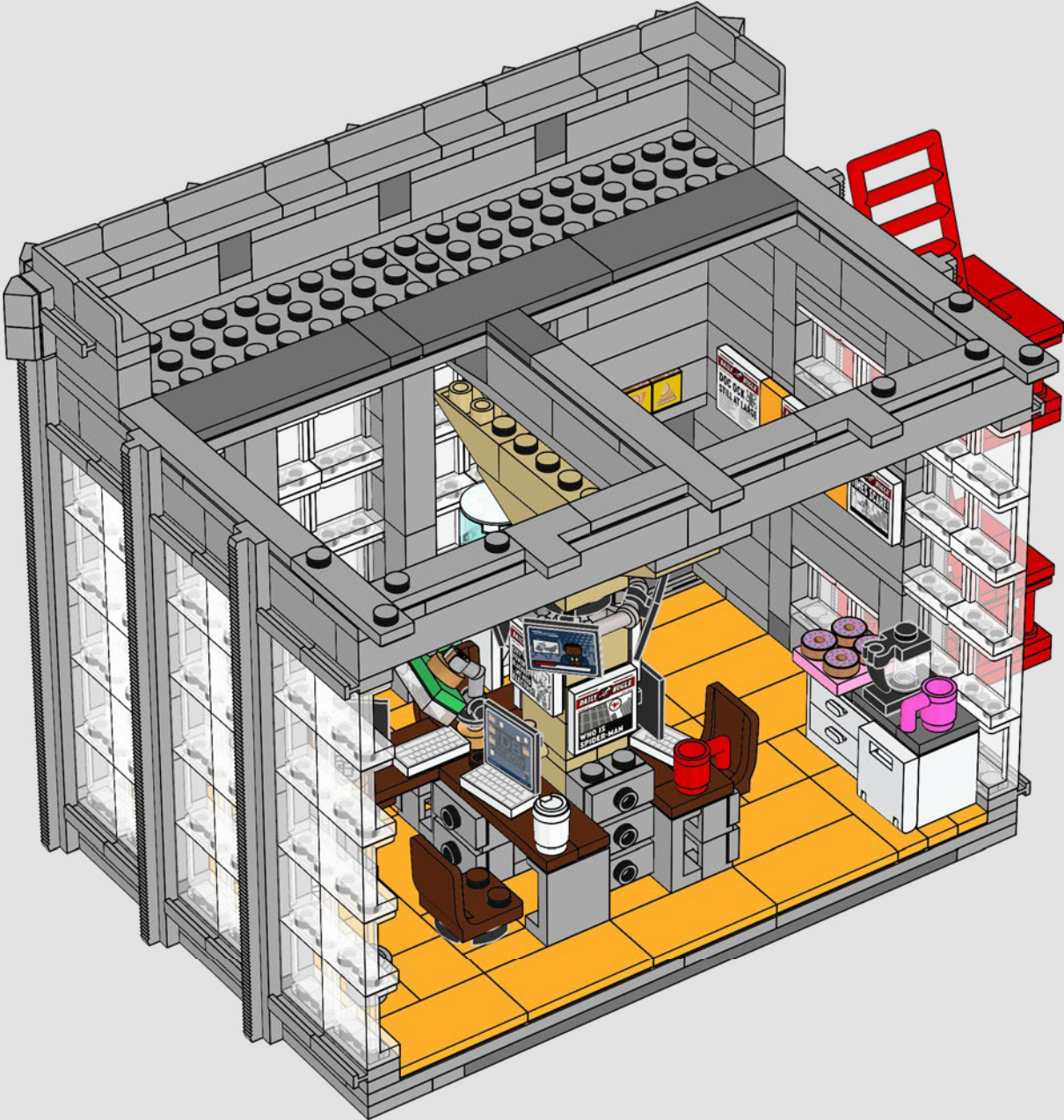



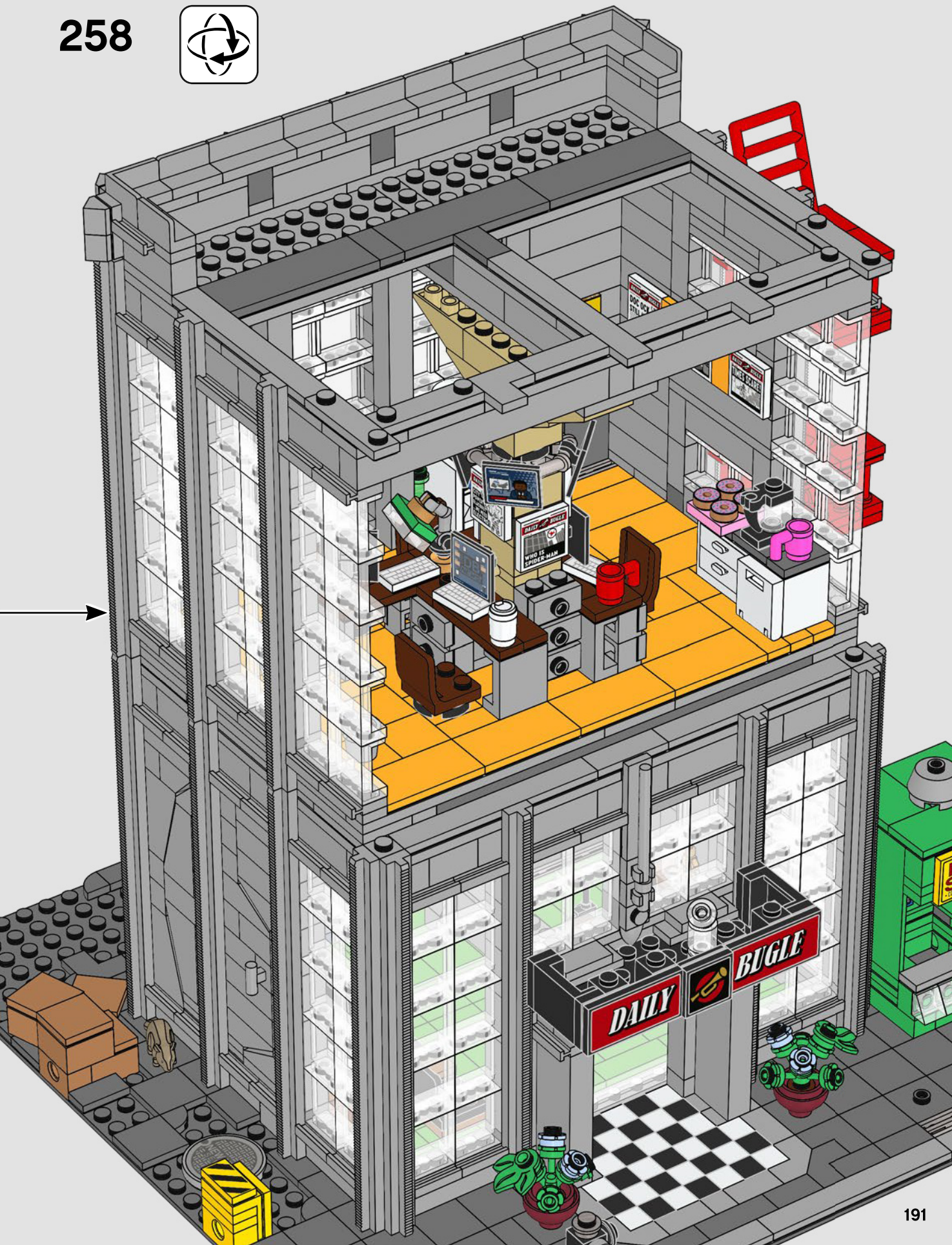



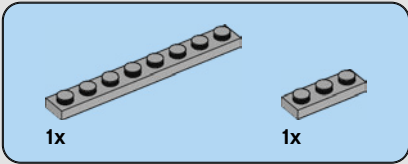
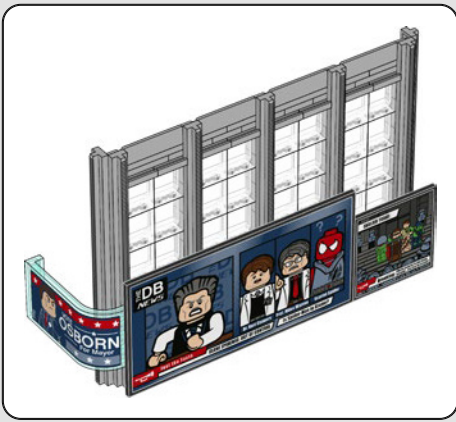

**259**

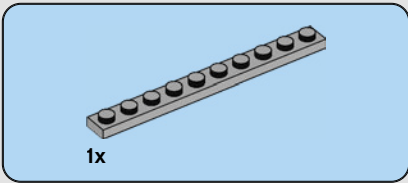
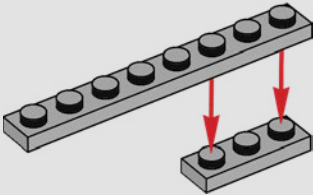

**260**

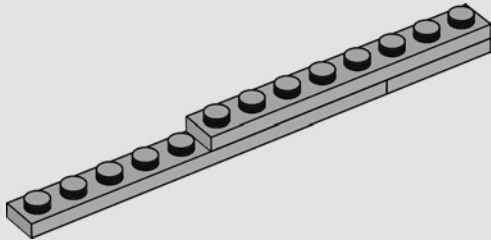

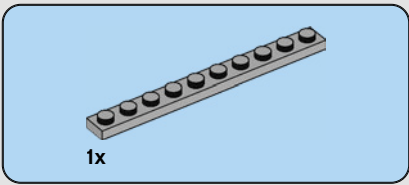

**261**

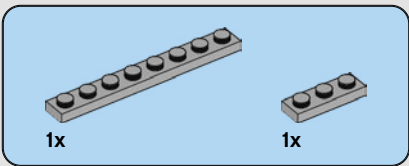
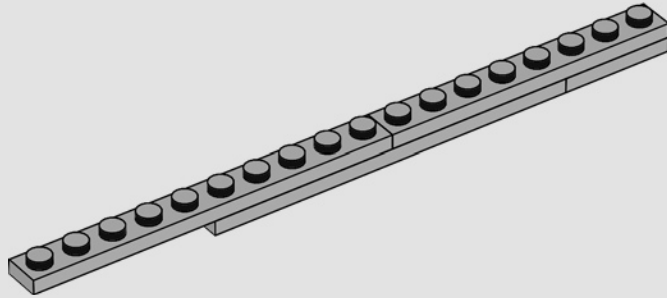

**262**

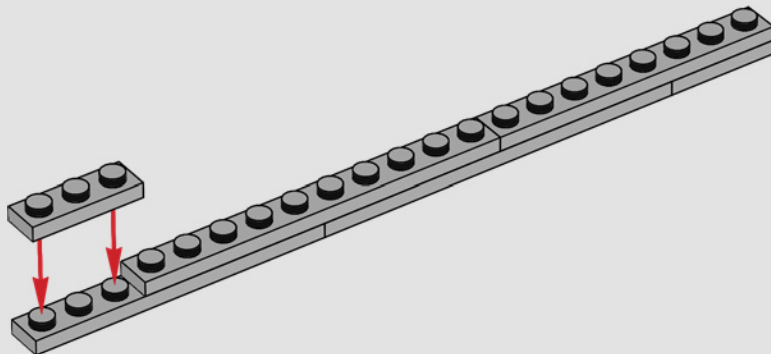



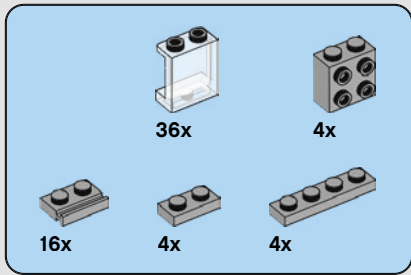

263

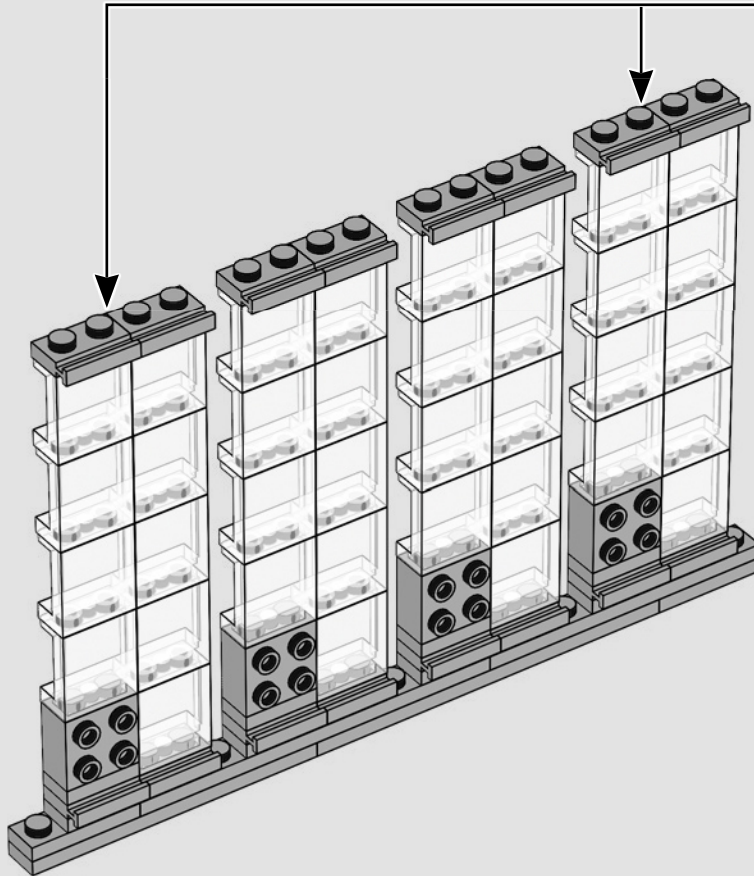
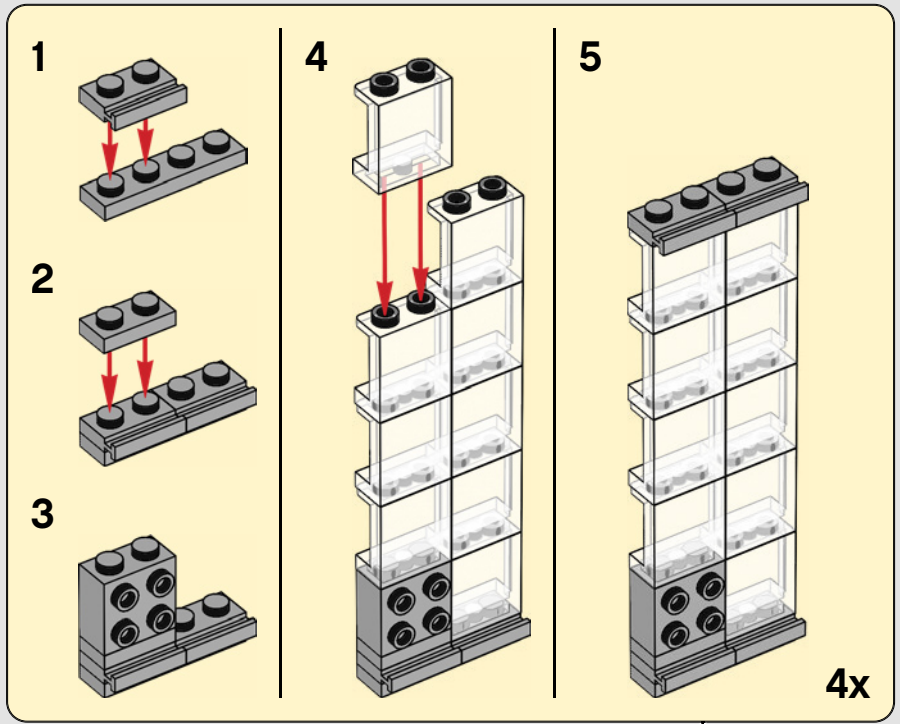

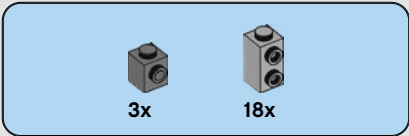

264

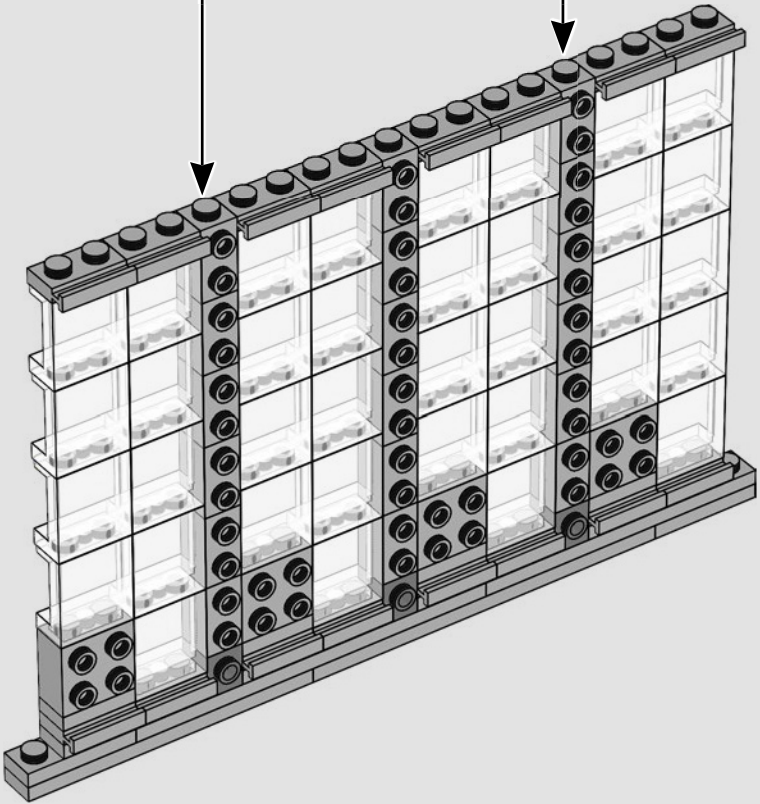
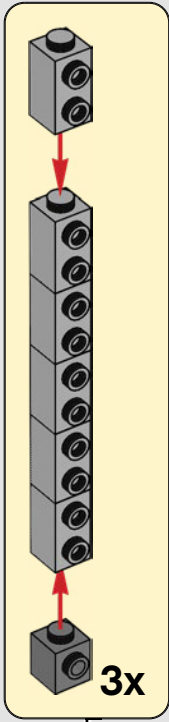





12x



2x

# 265

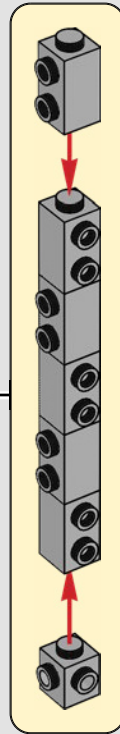
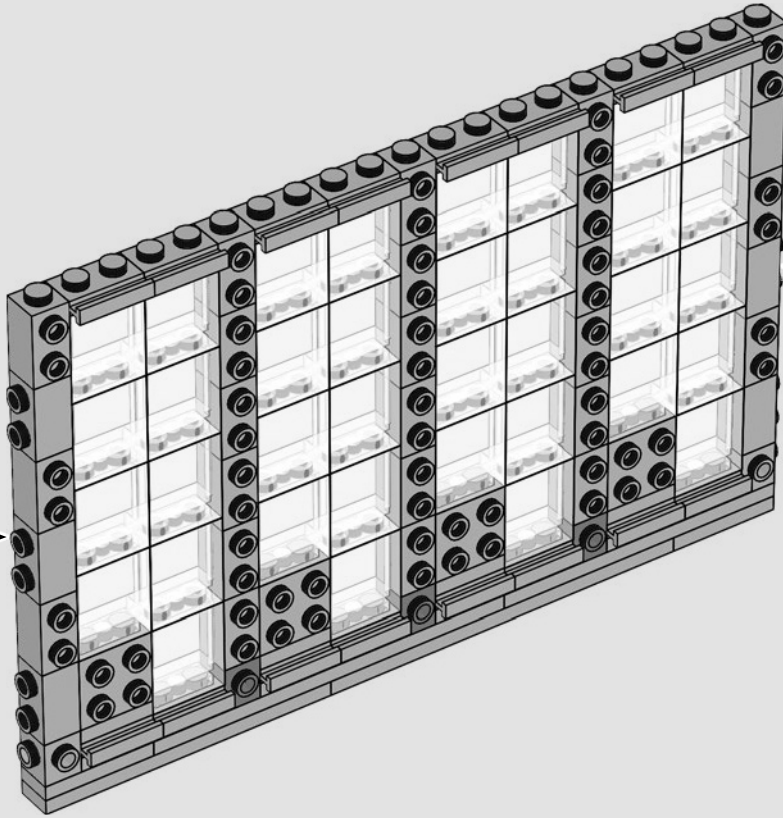
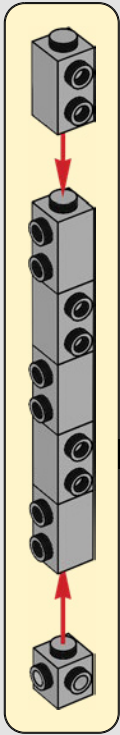

2x



3x



2x

# 266

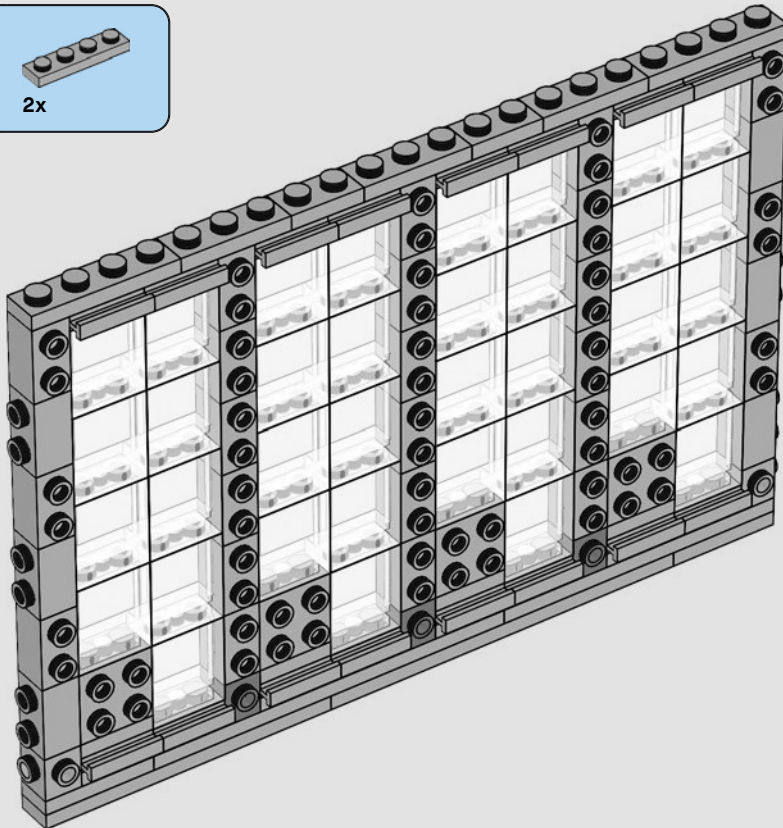

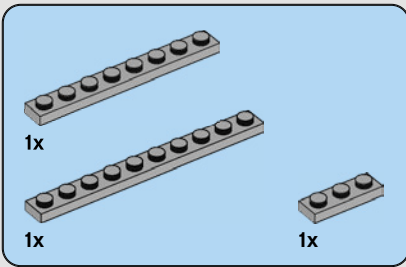

**267**

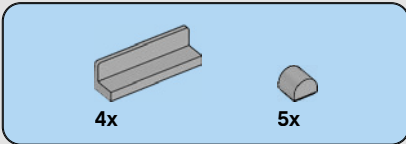
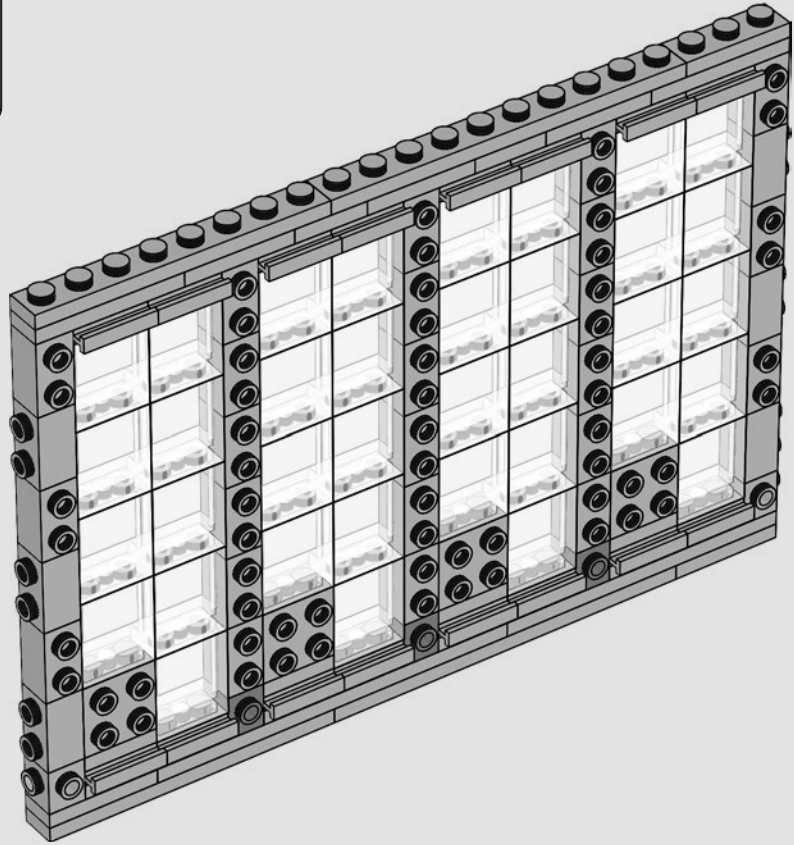

**268**

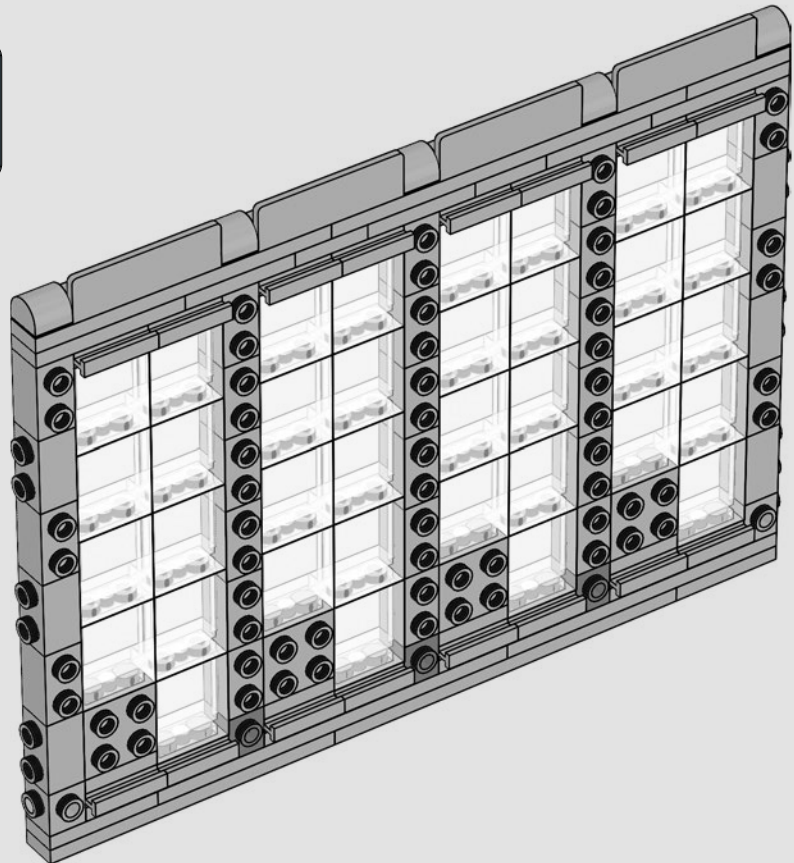



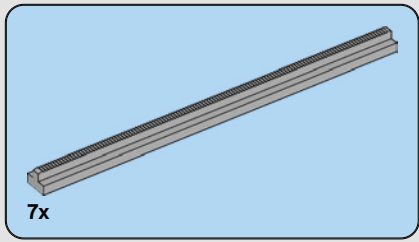

269

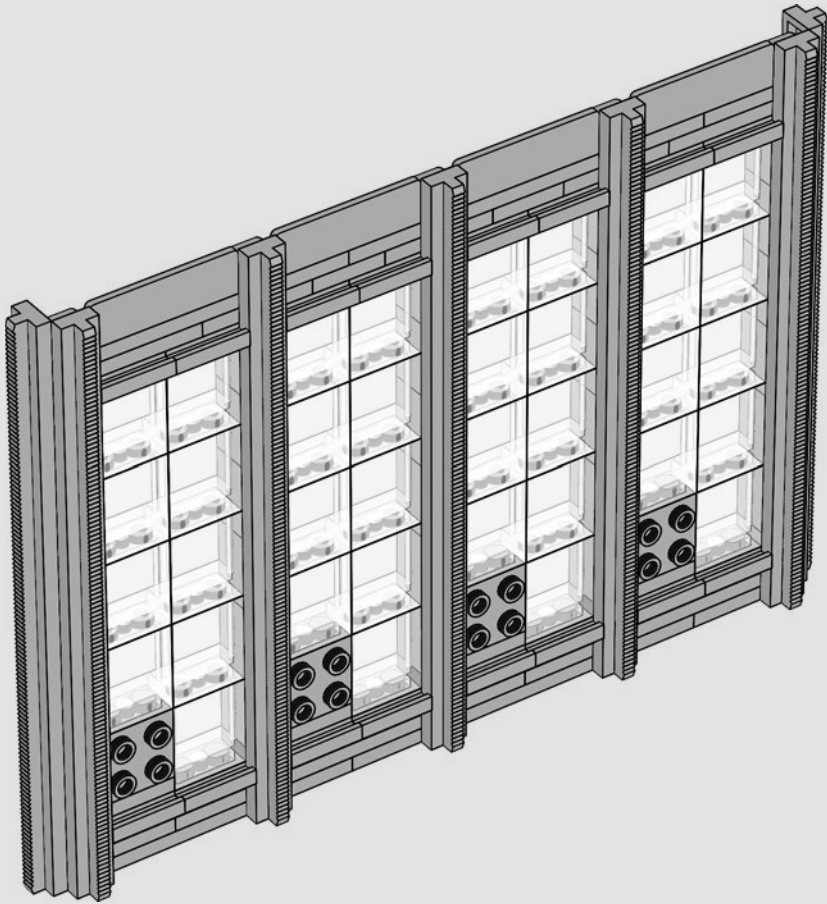

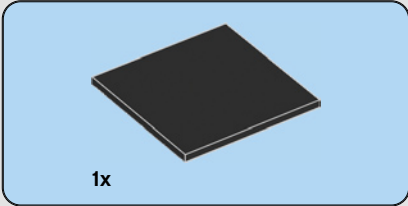
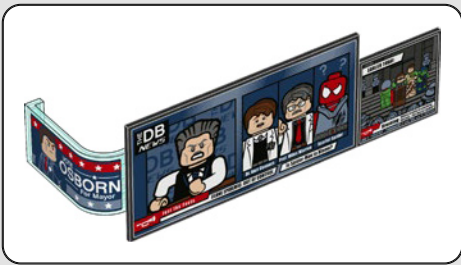

1x

**270**

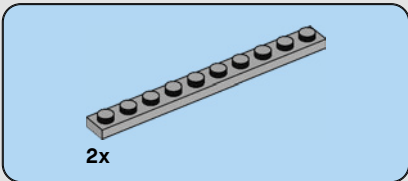
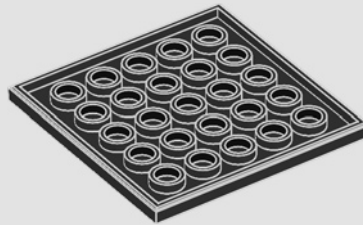

2x

**271**

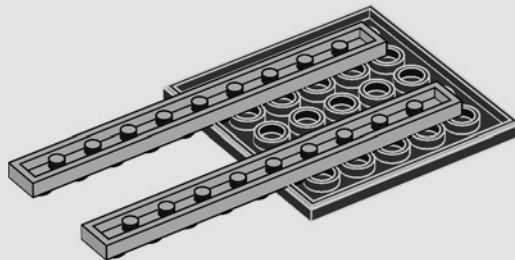



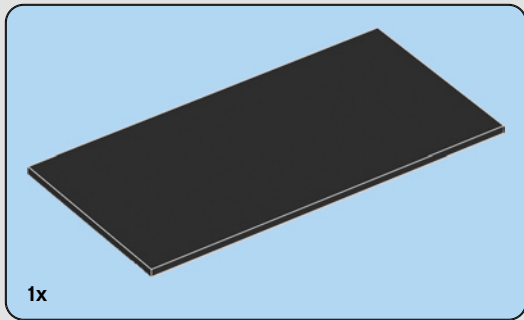

1x

**272**

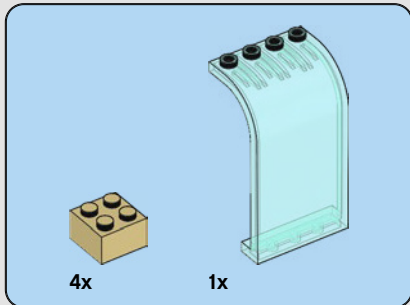
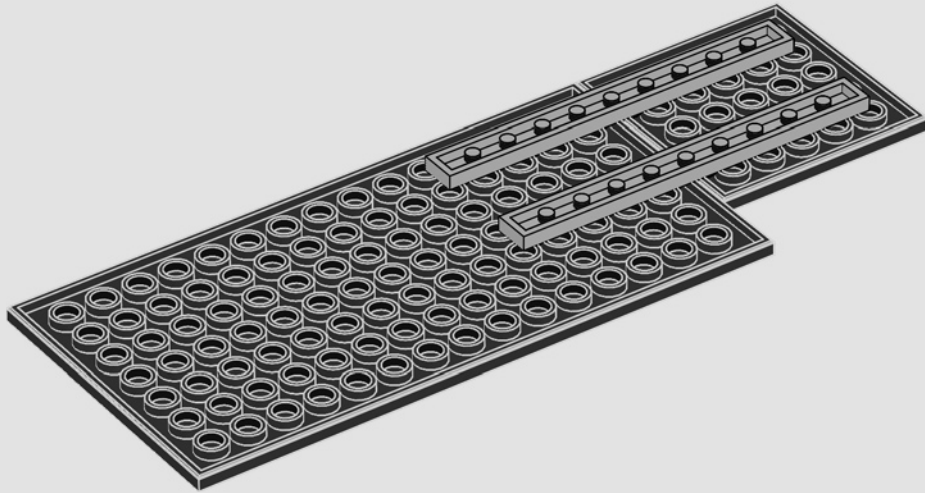

4x

1x

**273**

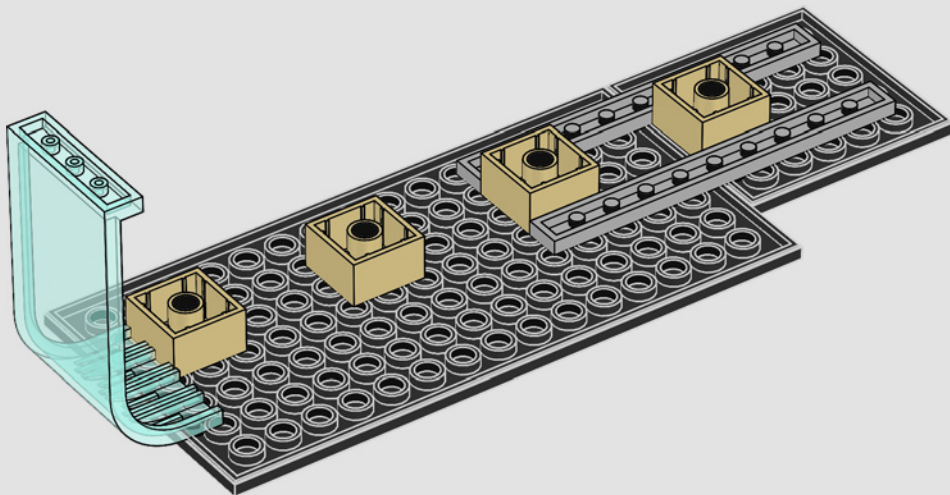

274



275

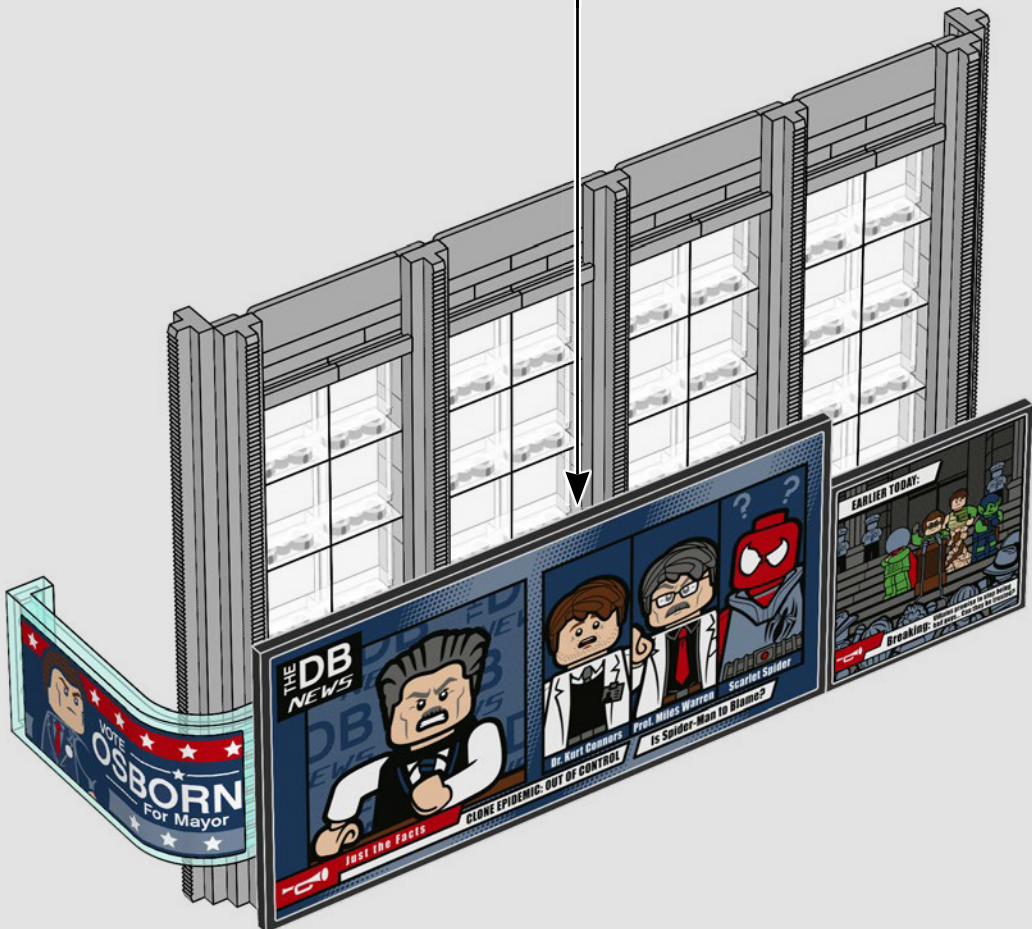





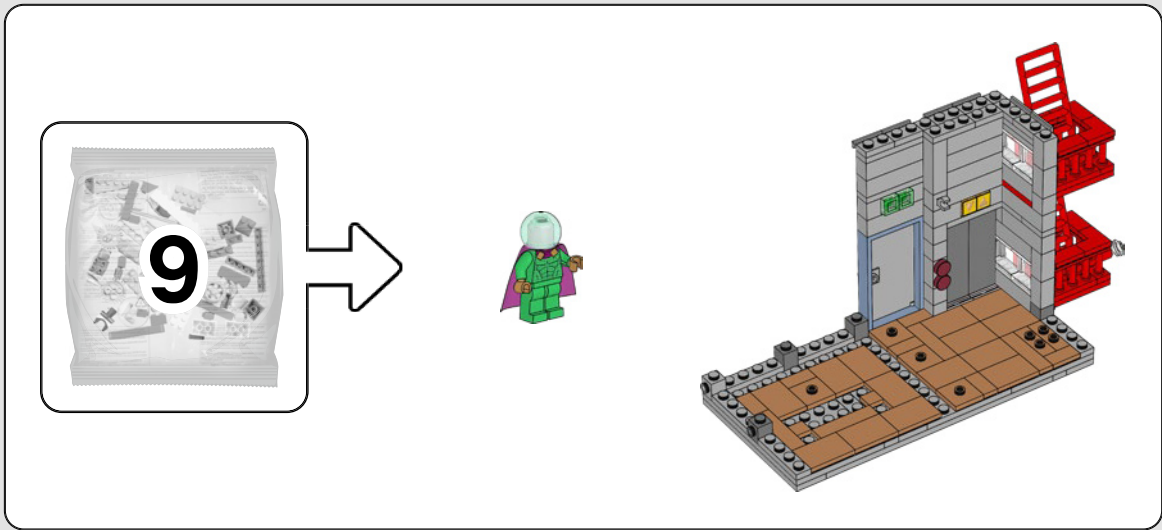

1

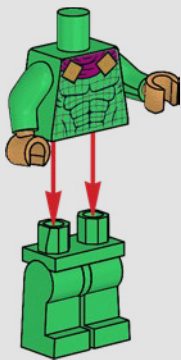

2

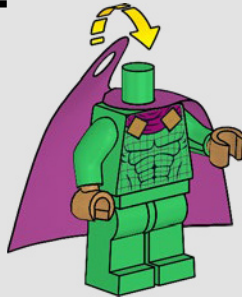

3

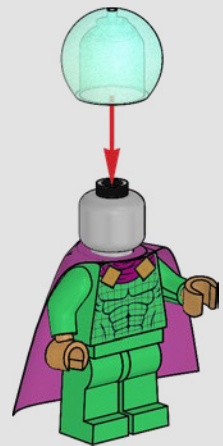



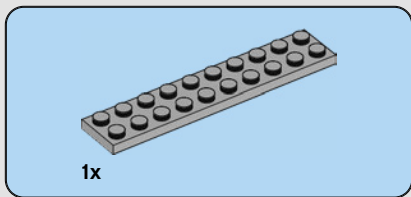
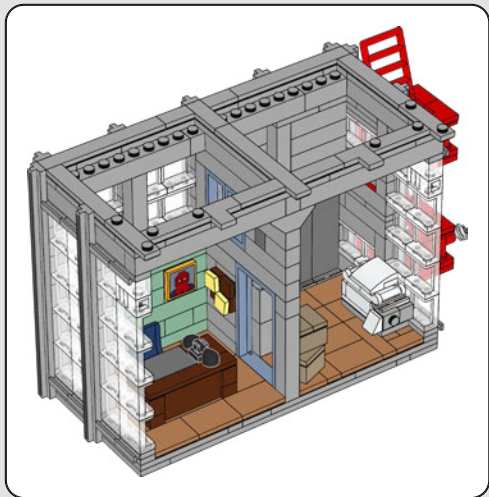

**277**

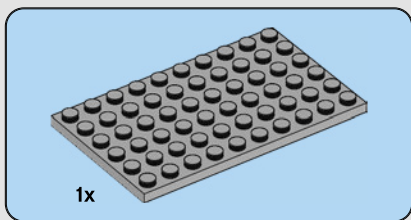
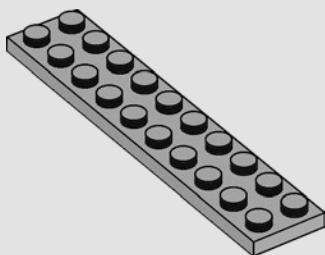

**278**

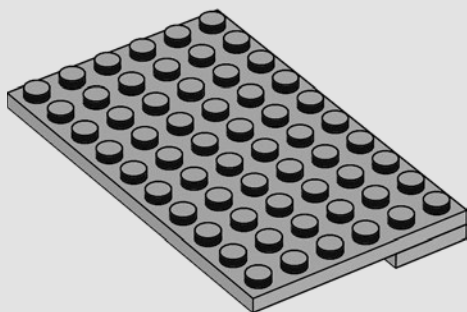

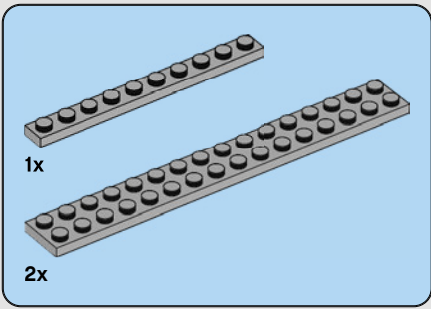

**279**

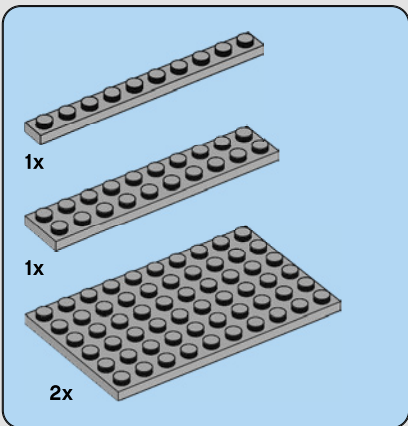
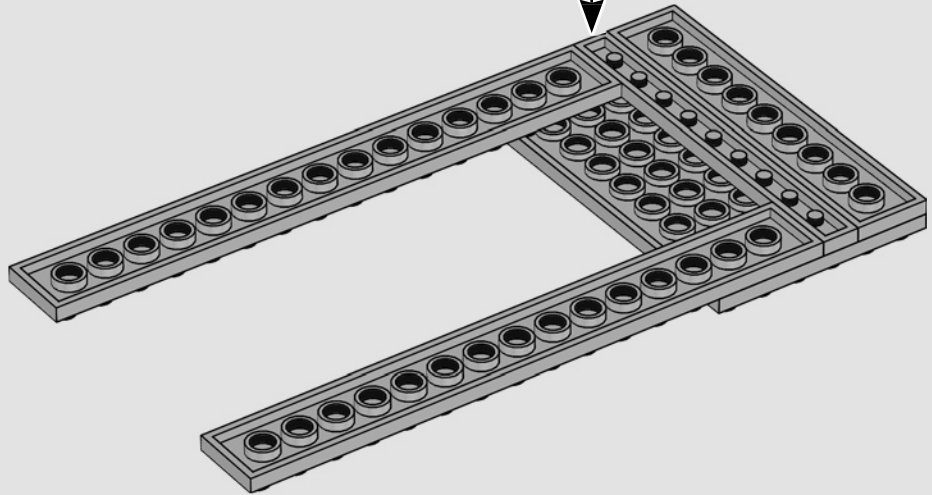
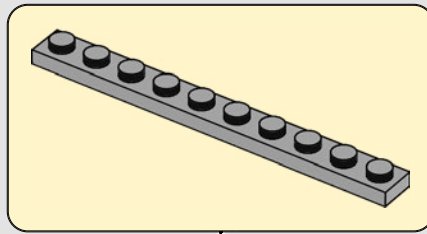

**280**

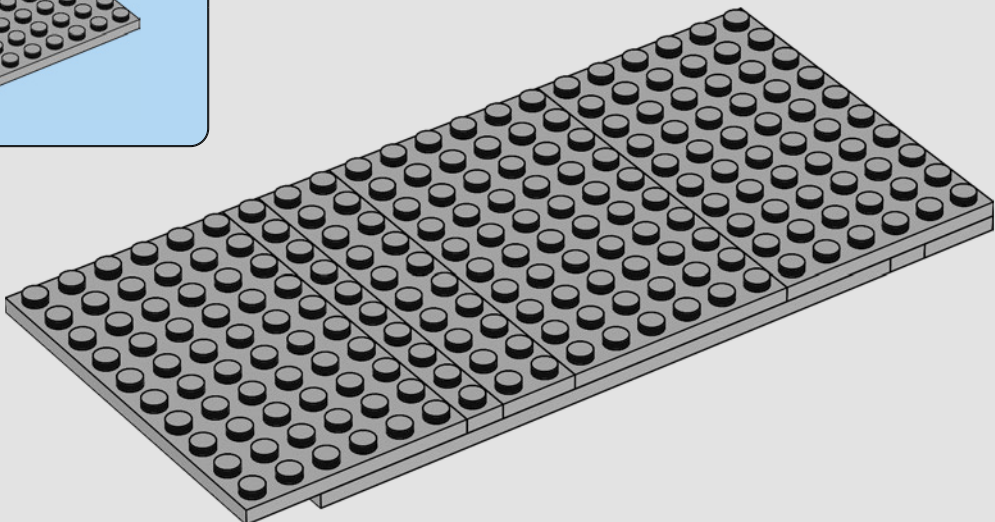



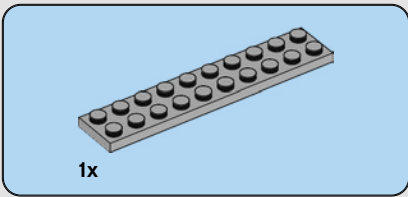

# 281

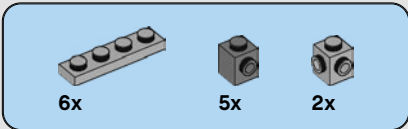
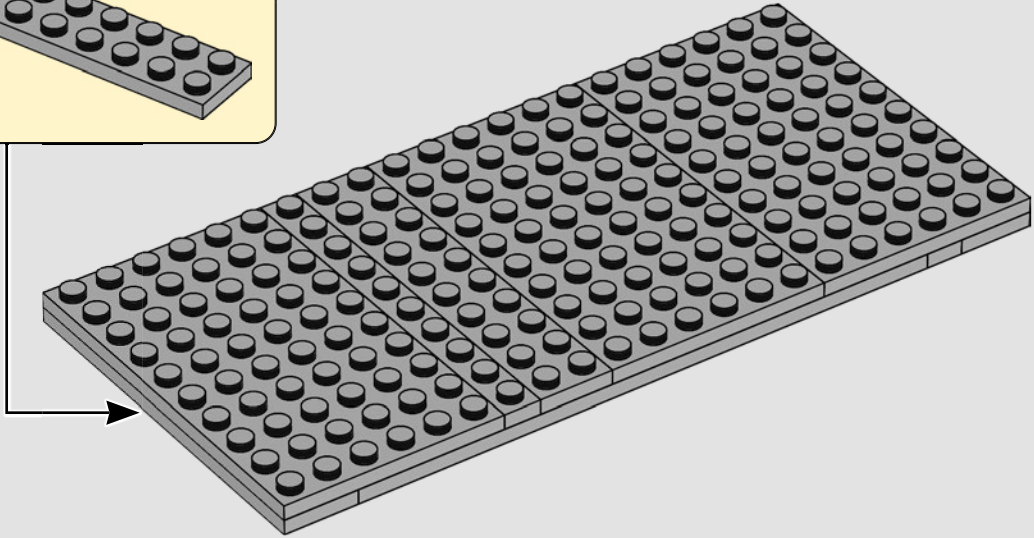
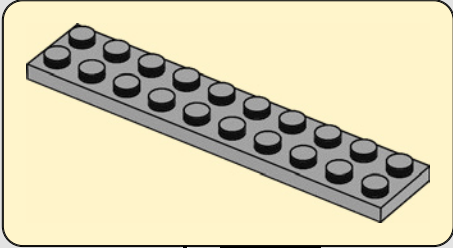

# 282

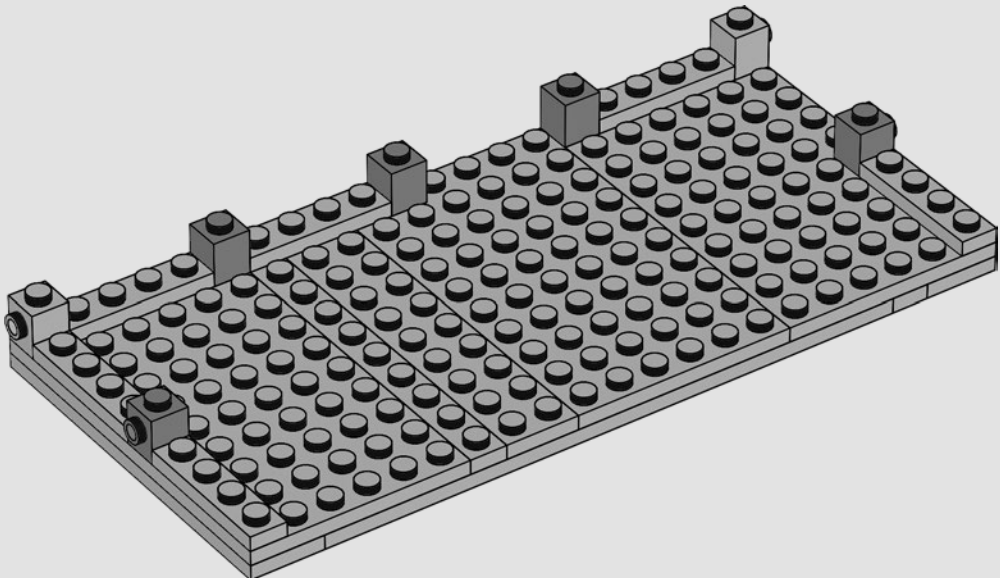

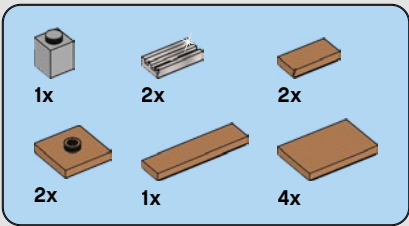

283

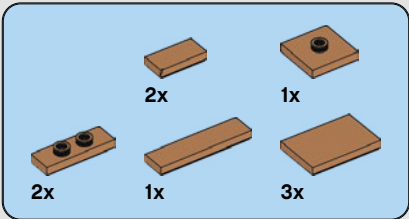
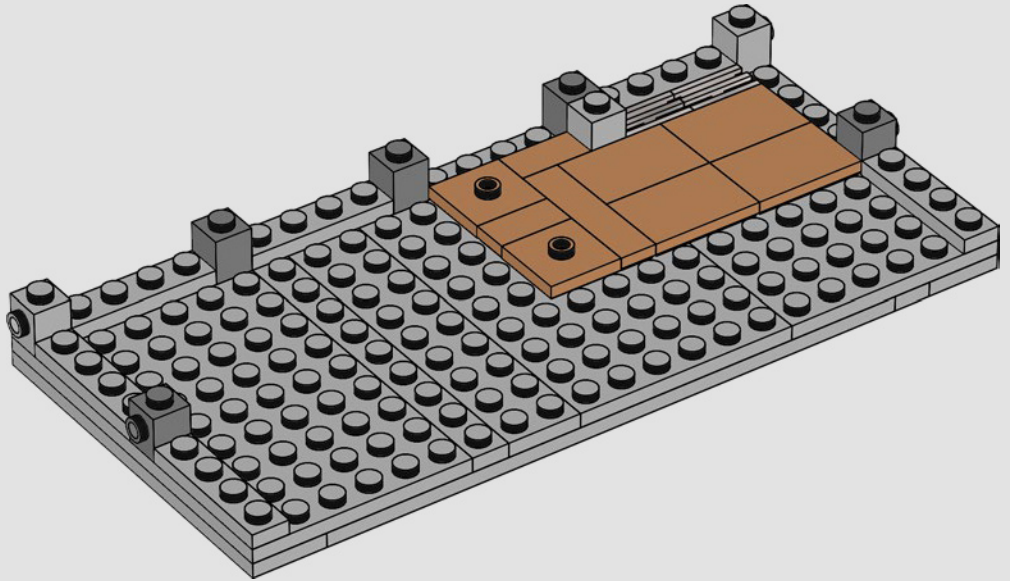

284

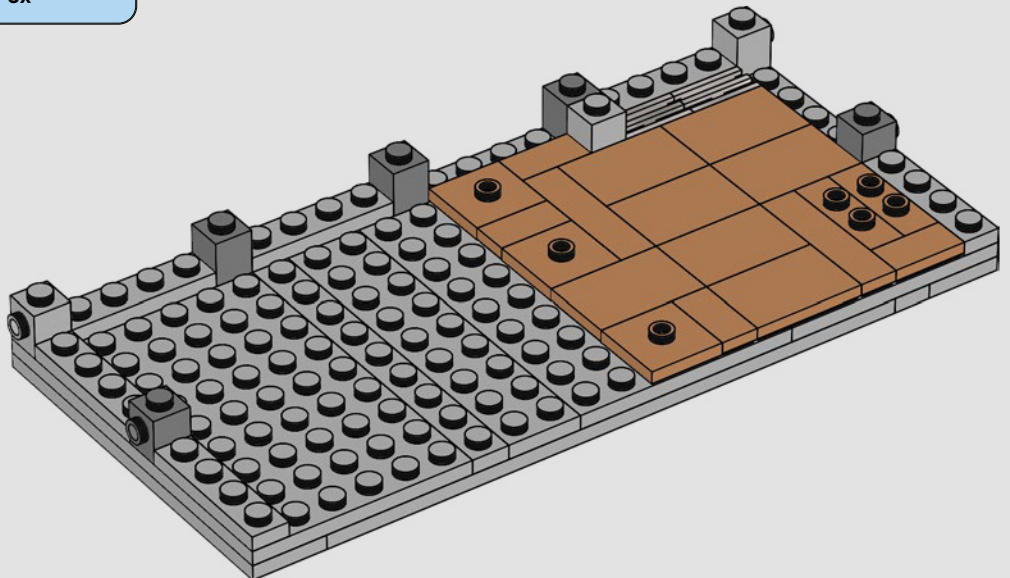

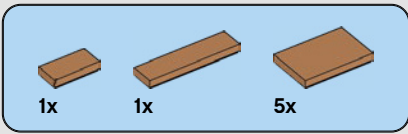

# 285

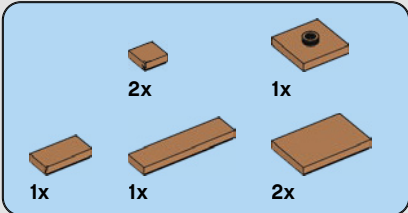
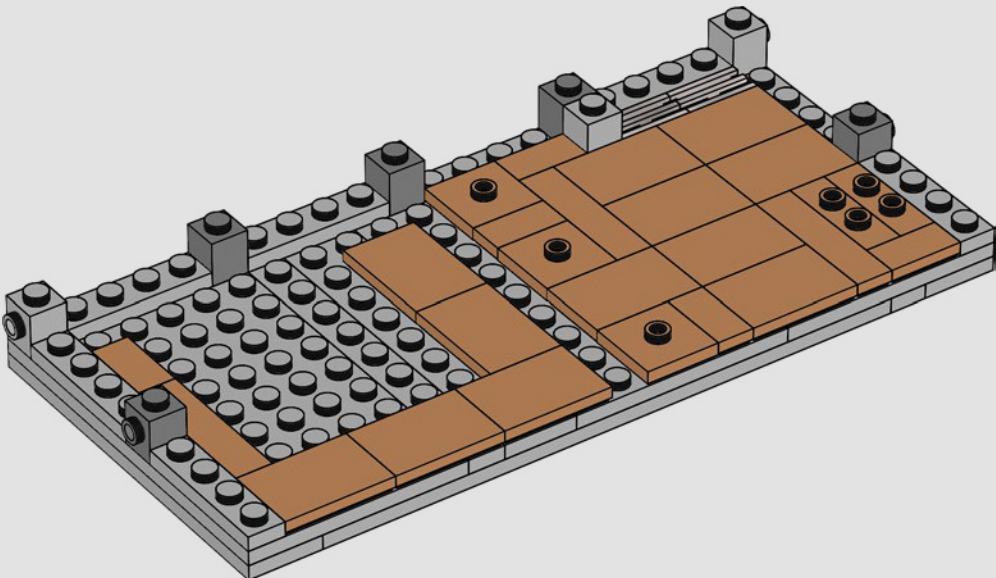

# 286

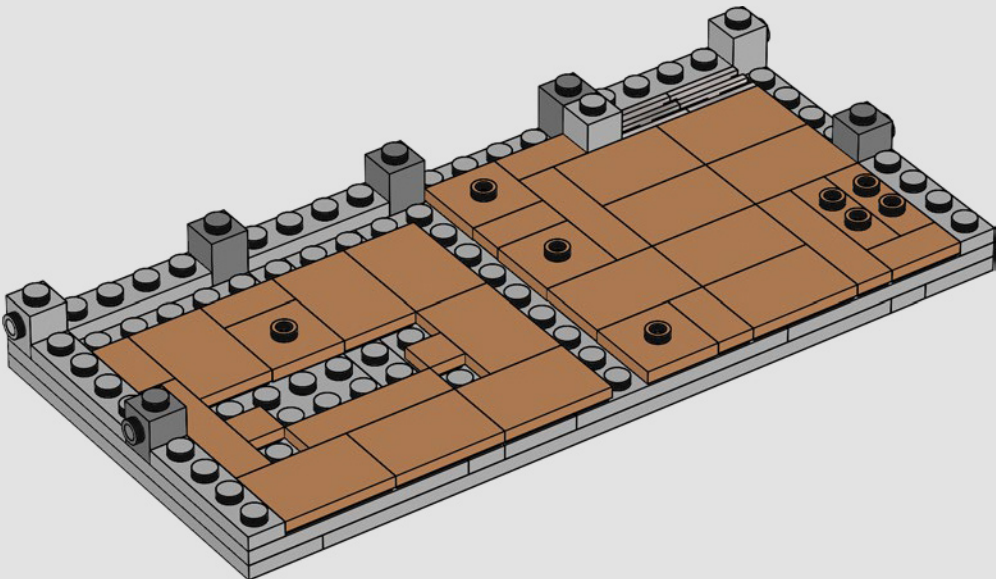



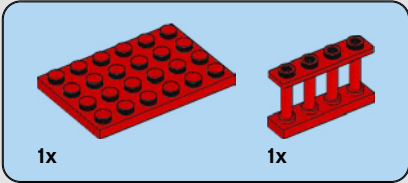
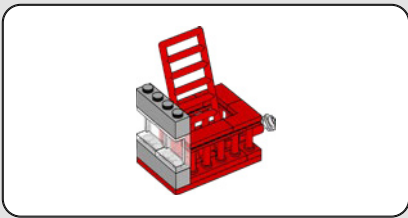

287

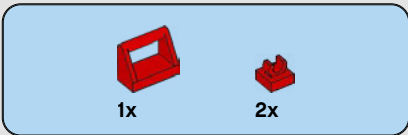
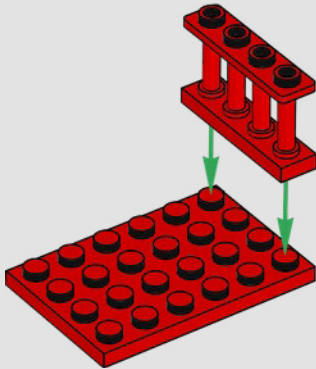

288

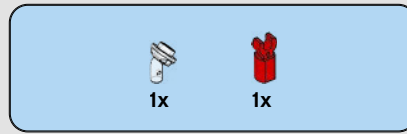
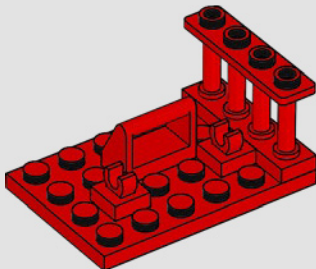

289

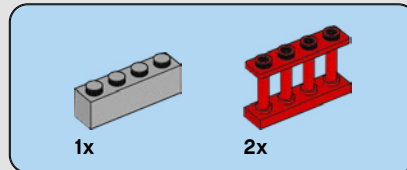
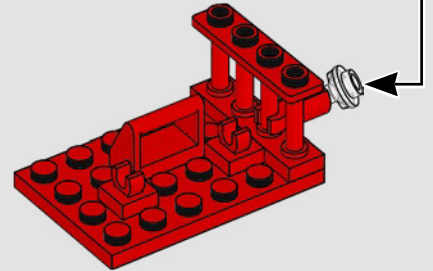
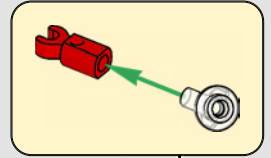

290

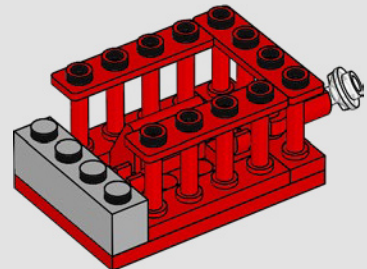

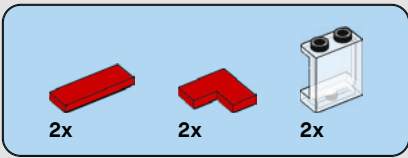

291

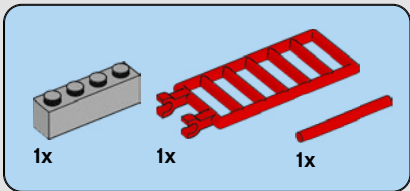
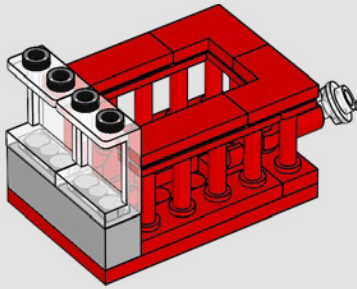

292

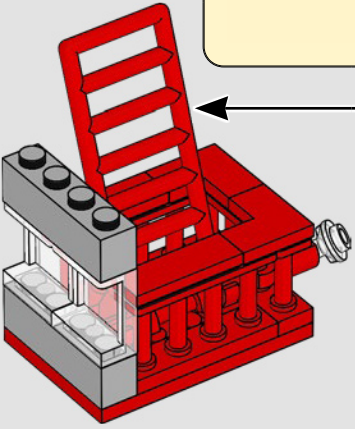
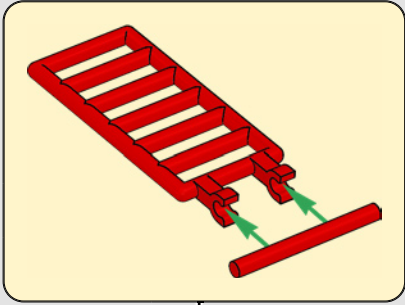

293

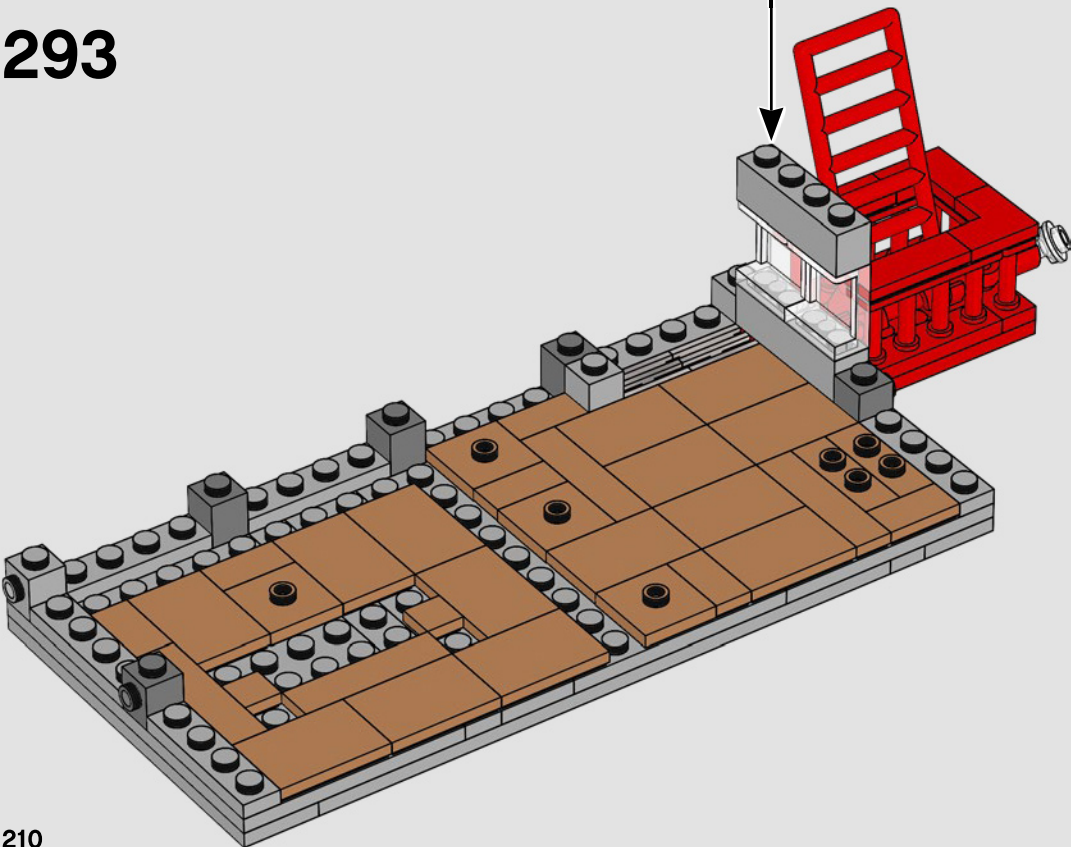

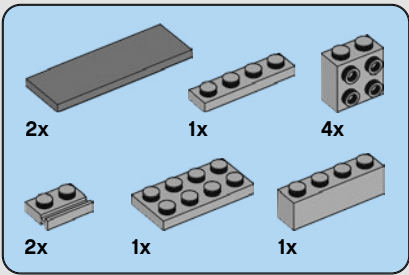

# 294

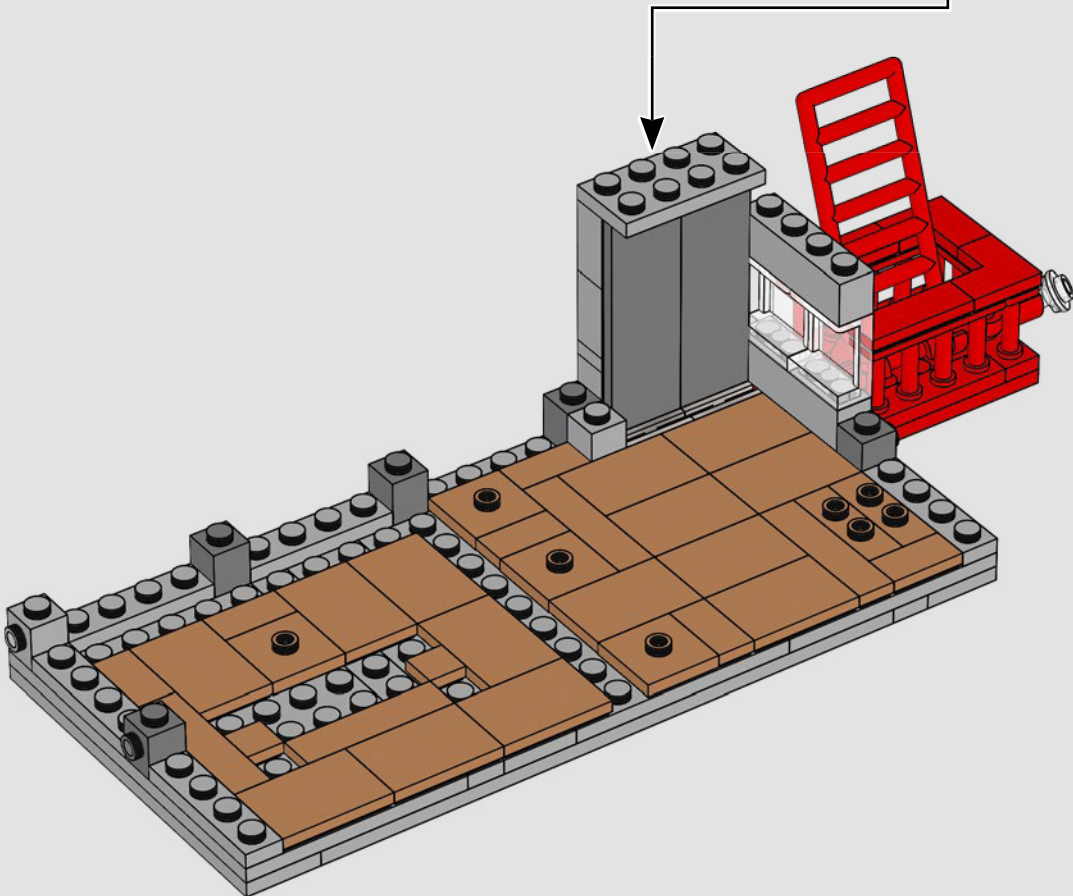
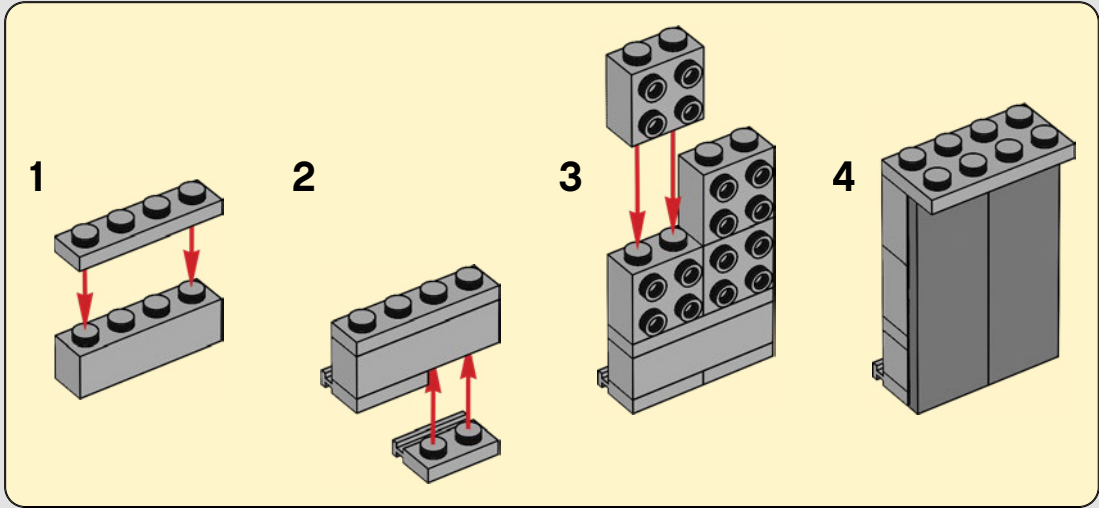



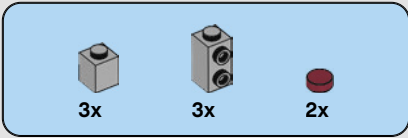

# 295

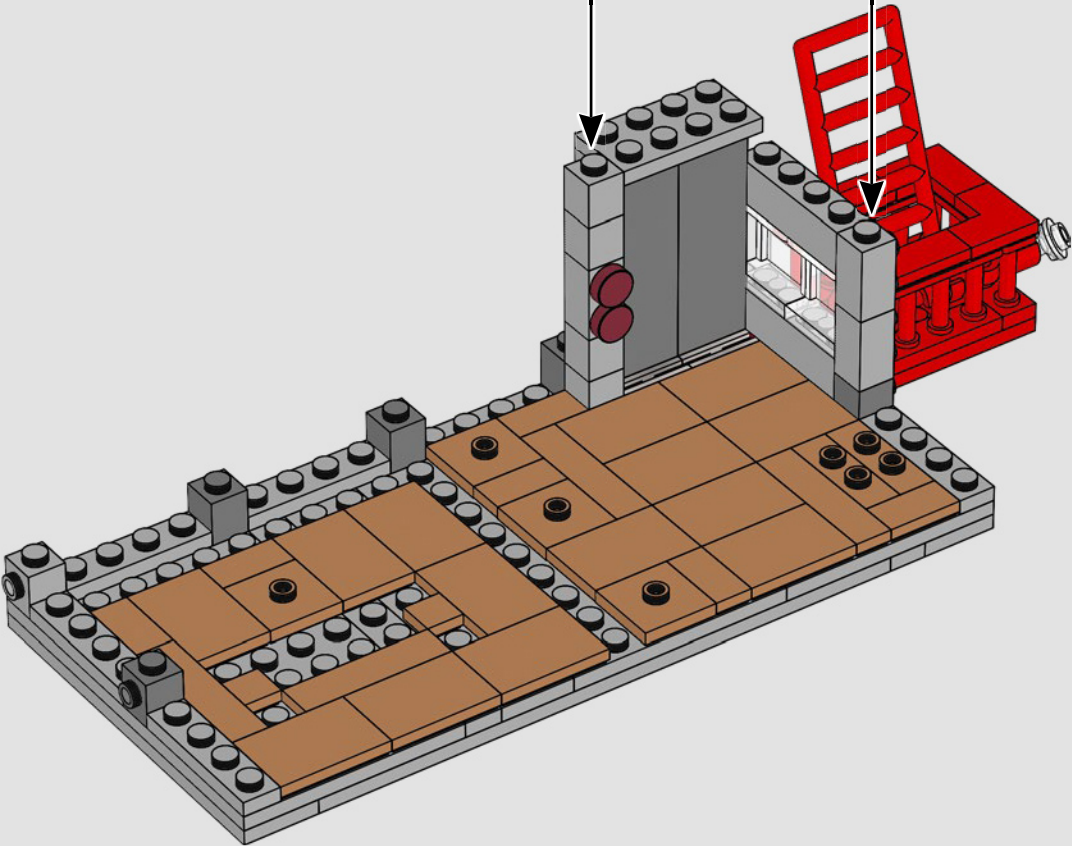
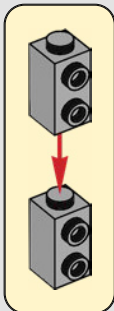
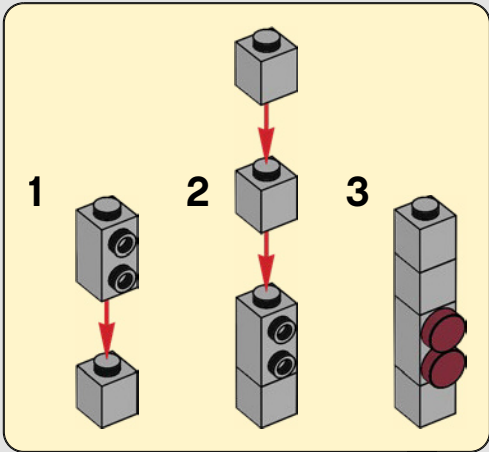

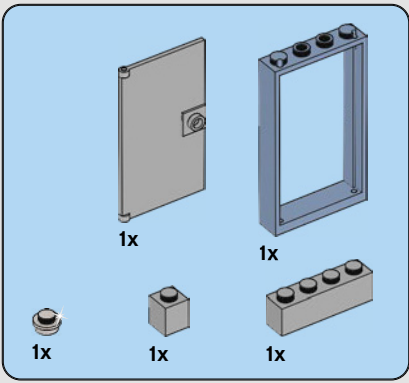

296

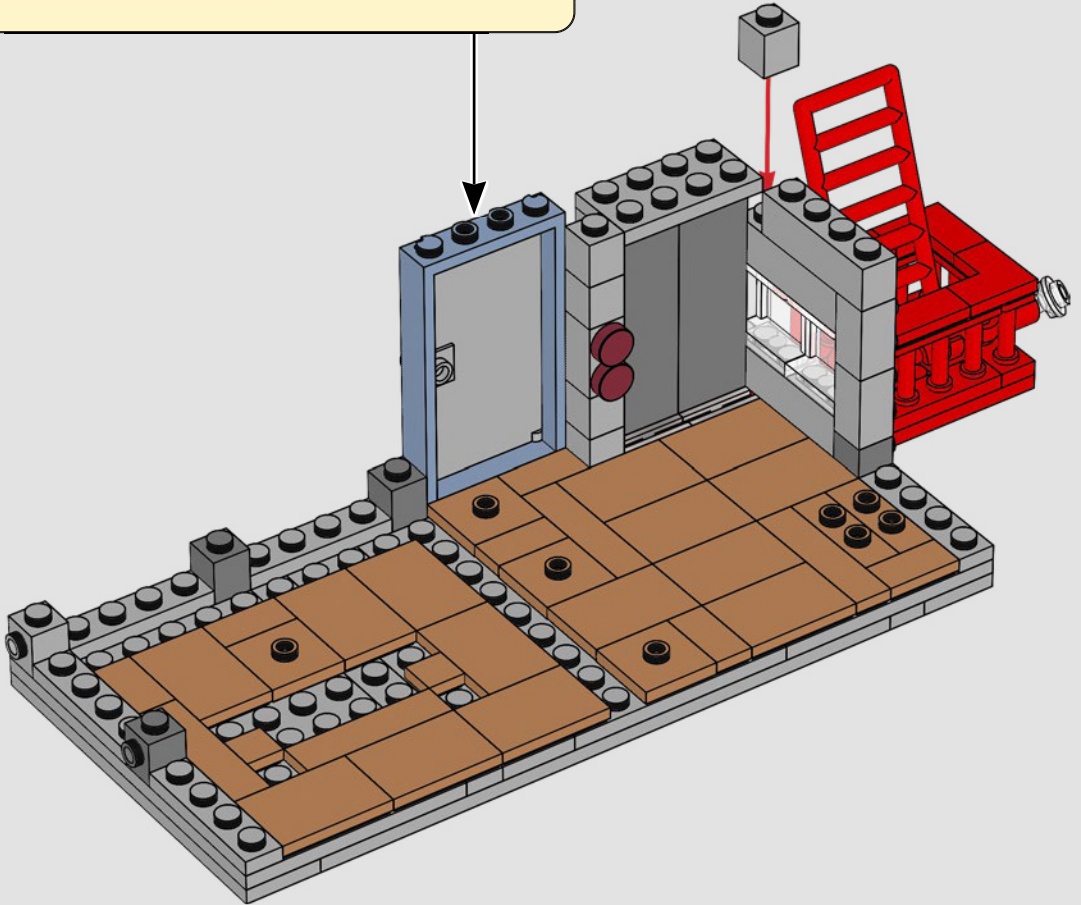
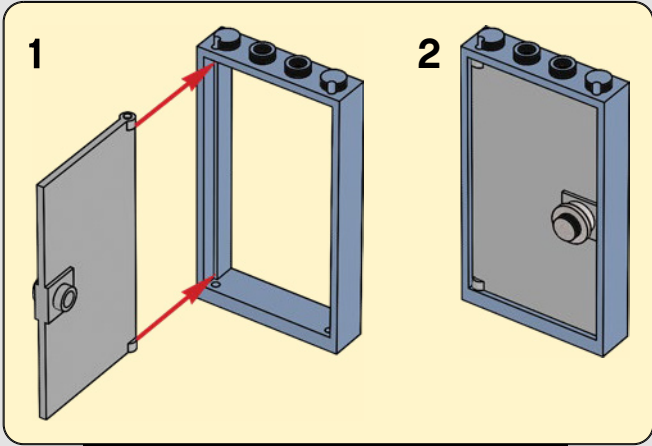

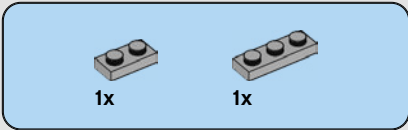

297

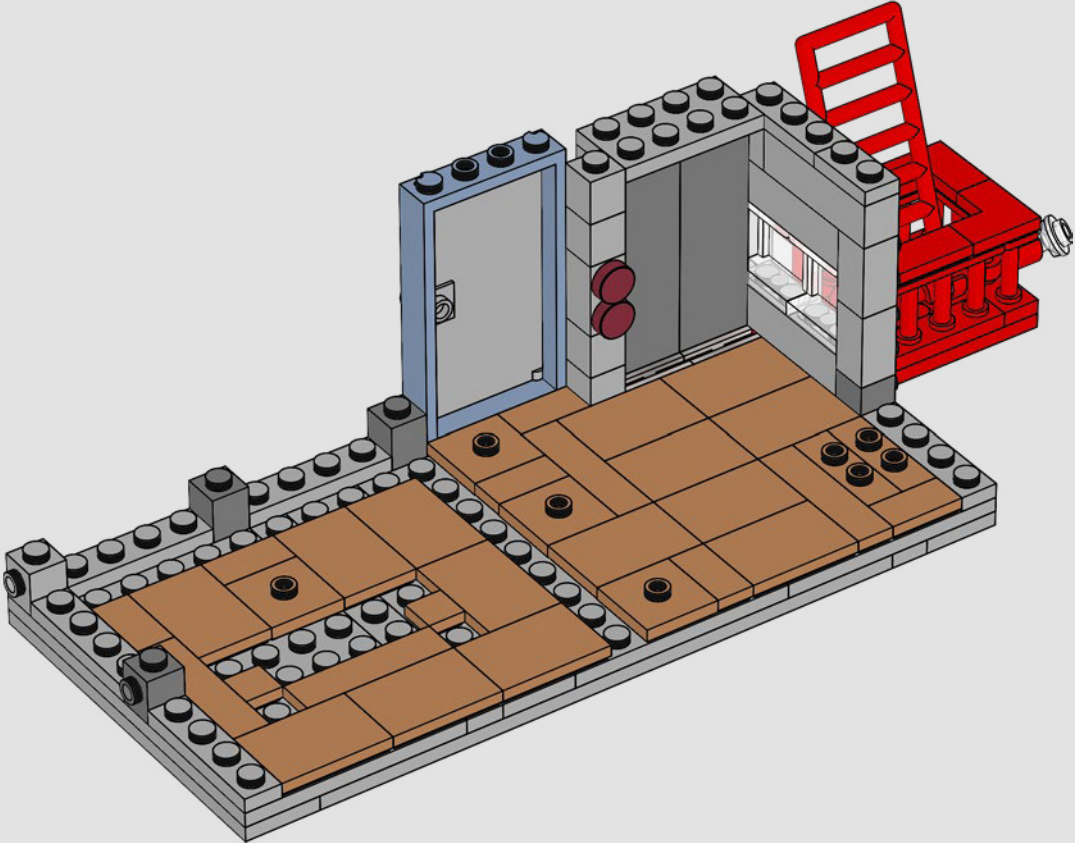



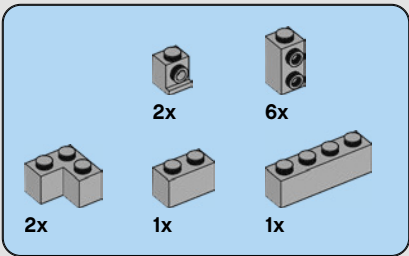

298

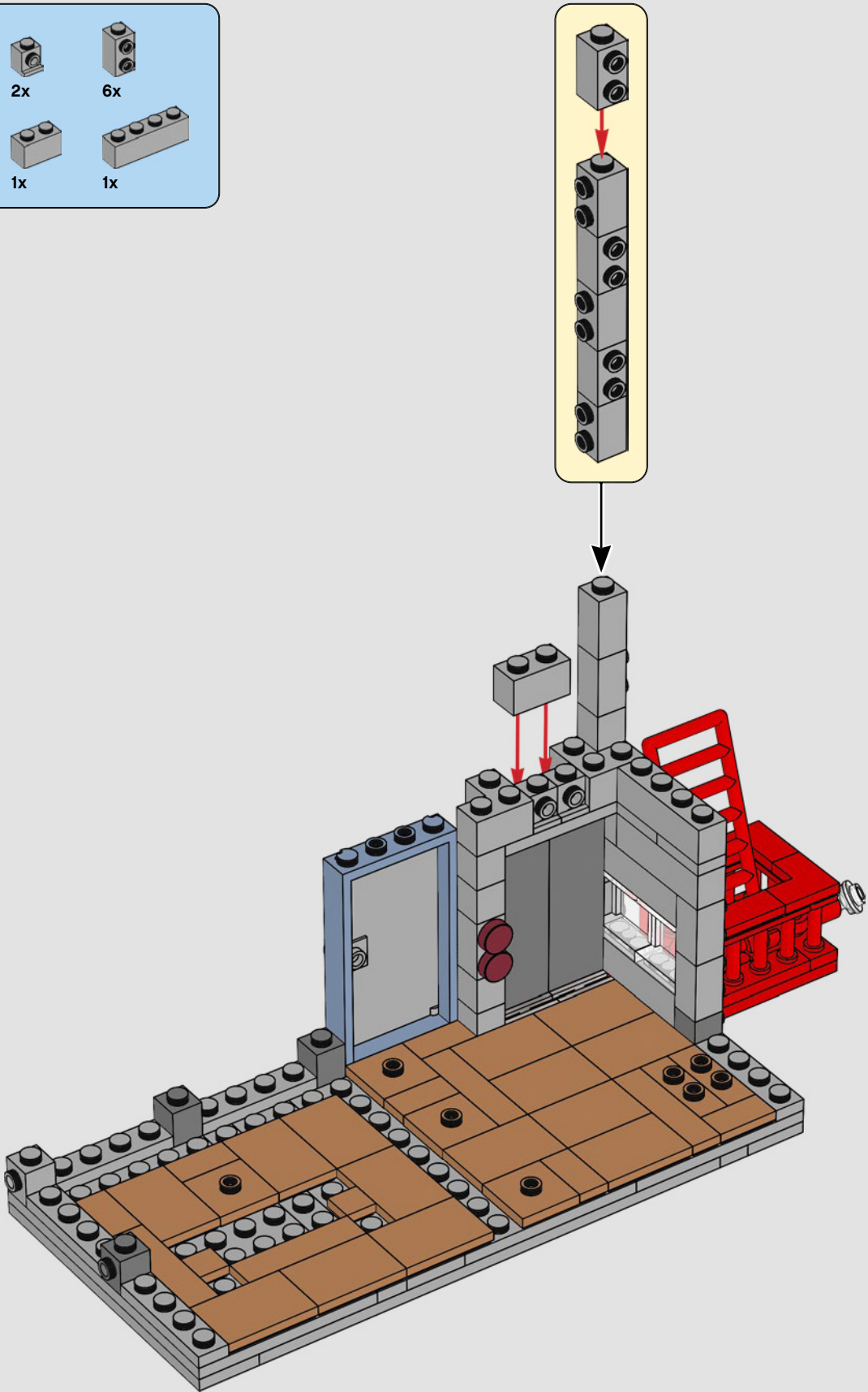

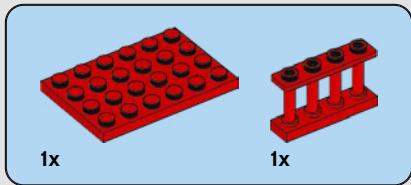

299

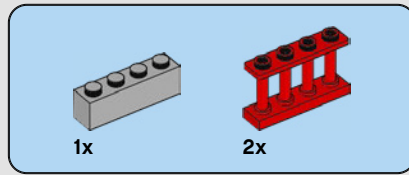
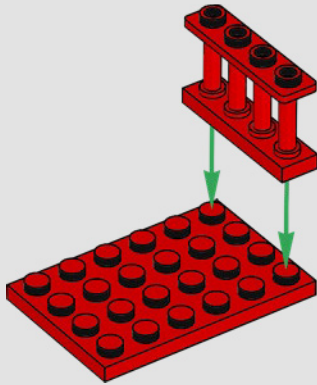

301

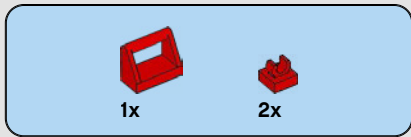
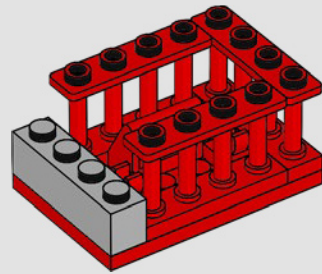

300

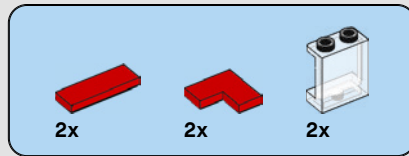
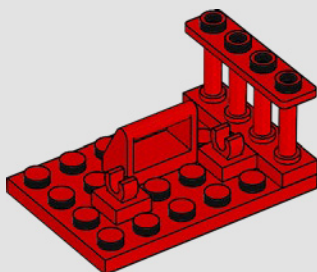

302

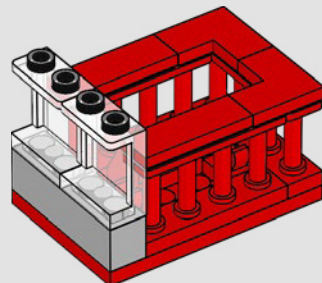

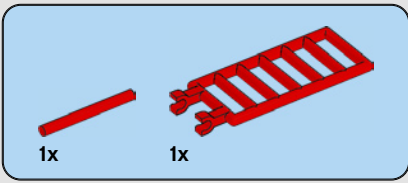

303

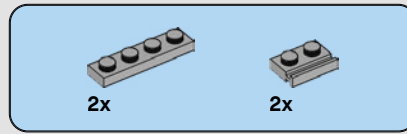
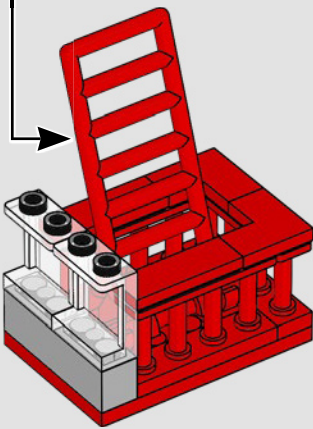
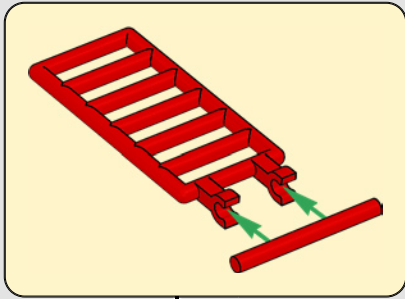

304

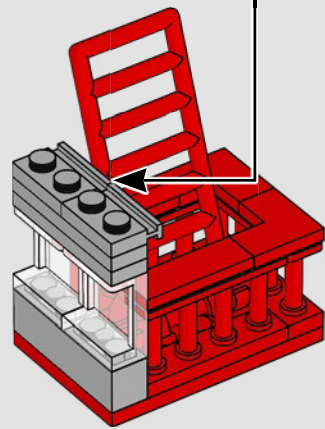
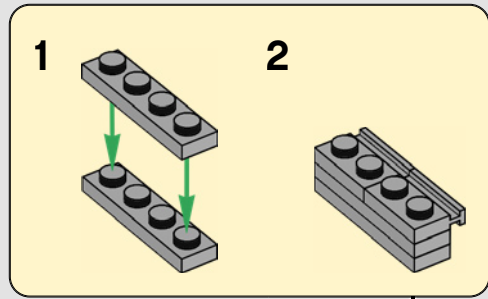

305

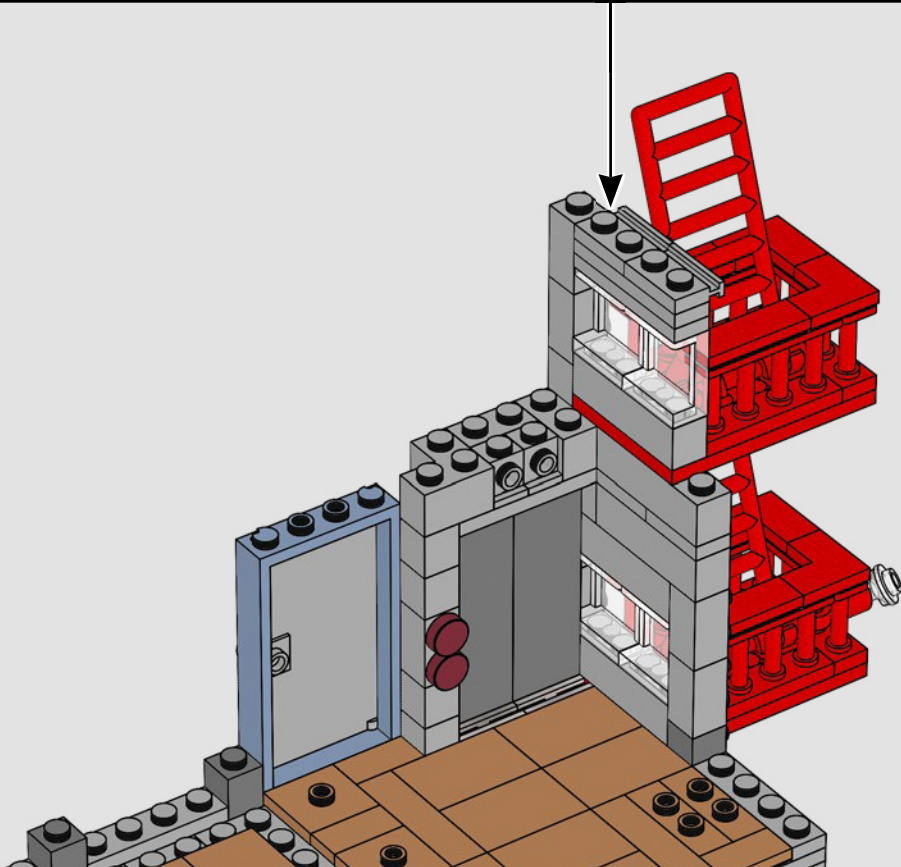



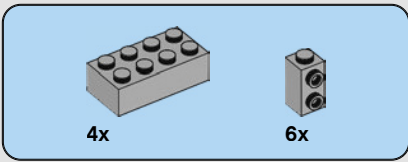

306

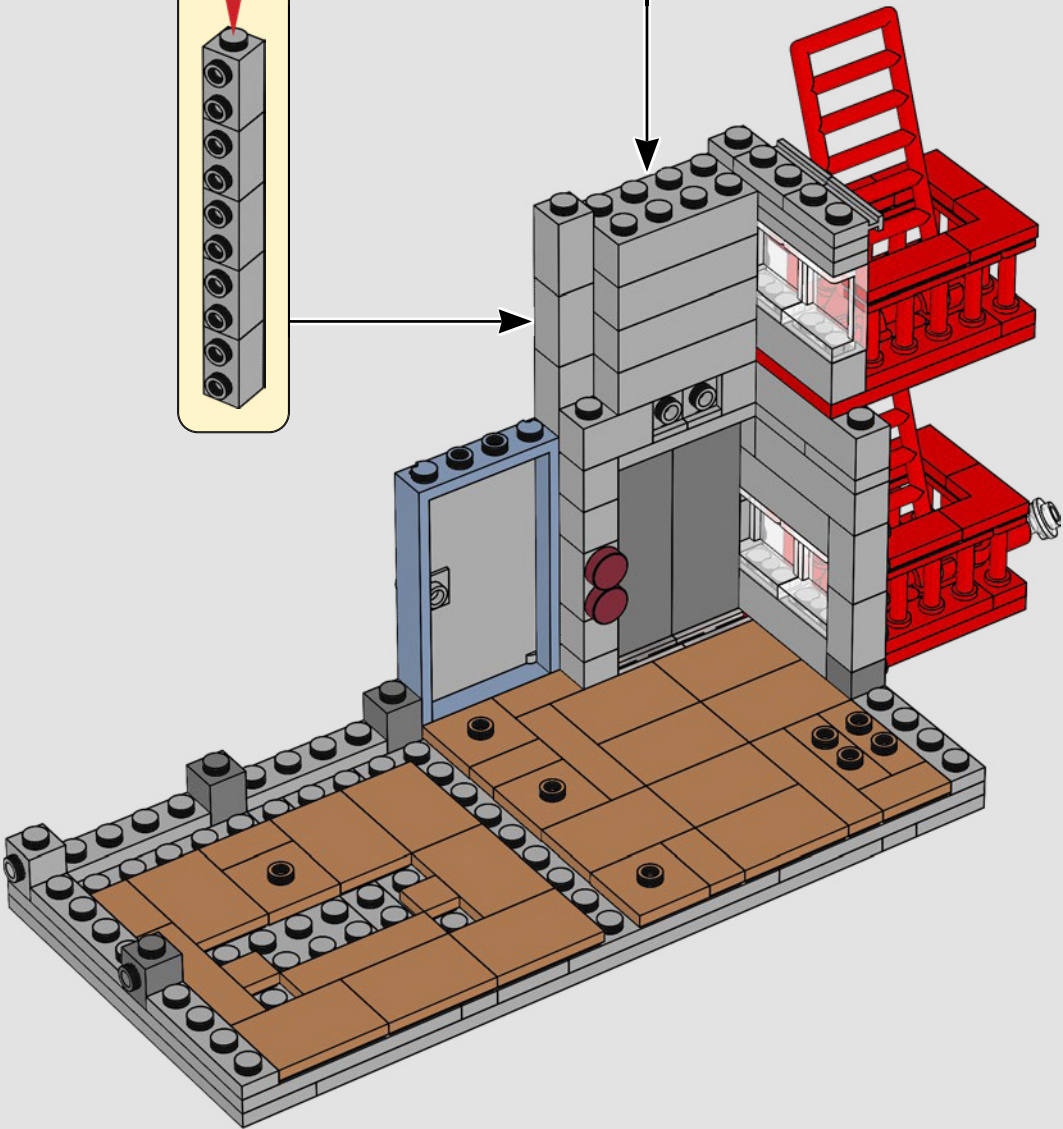
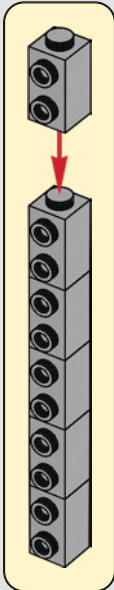
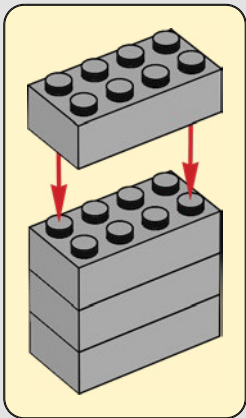

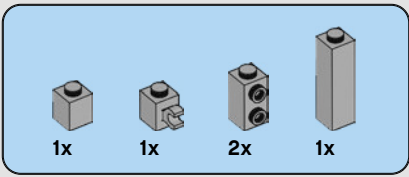

307

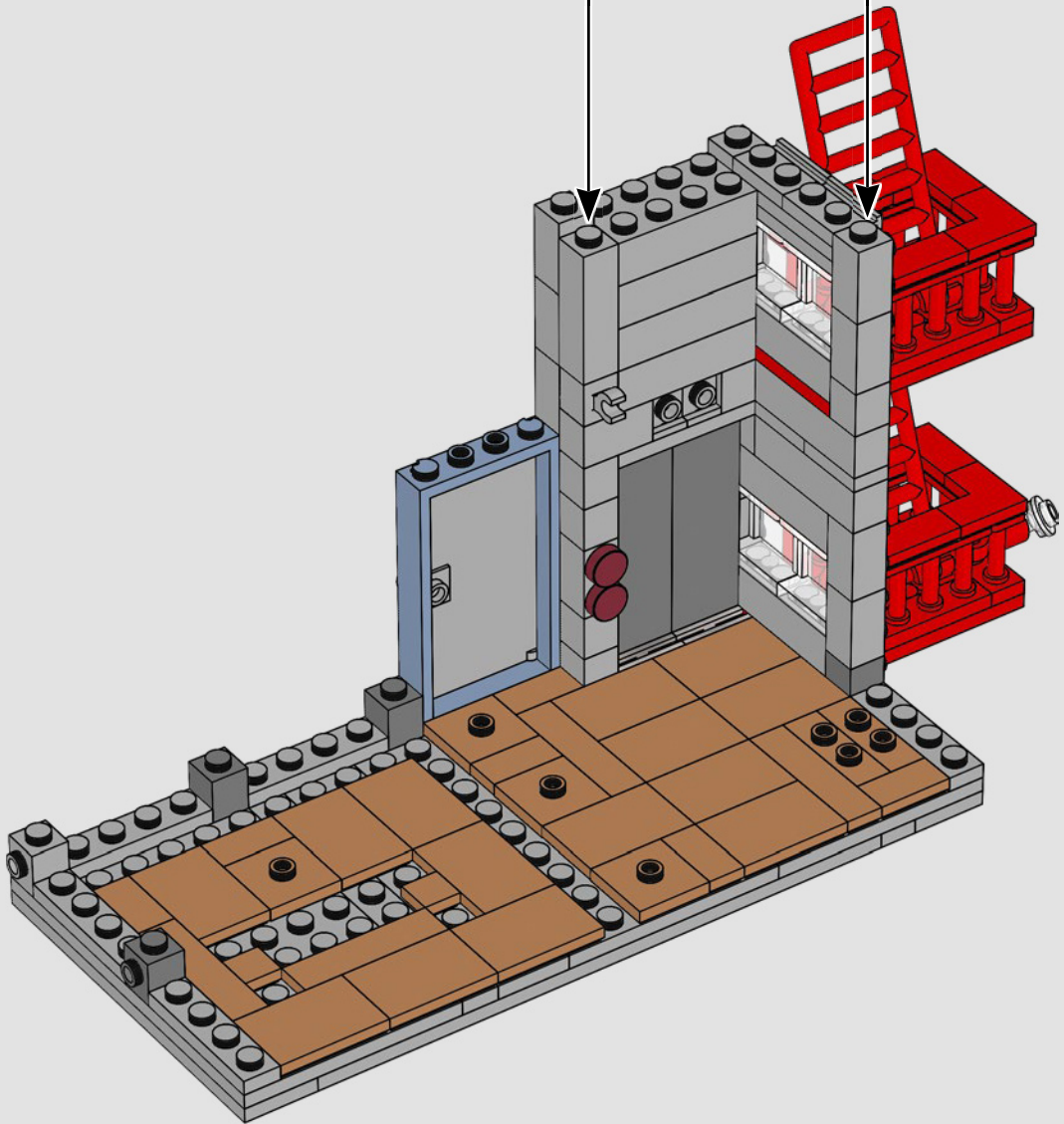
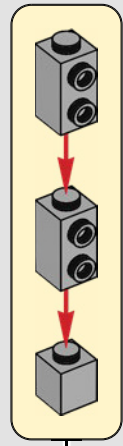
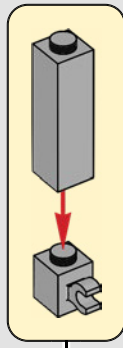

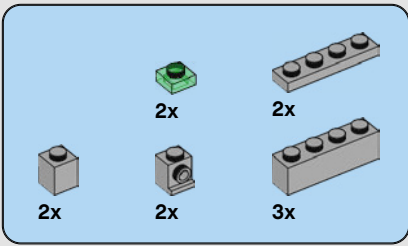

308

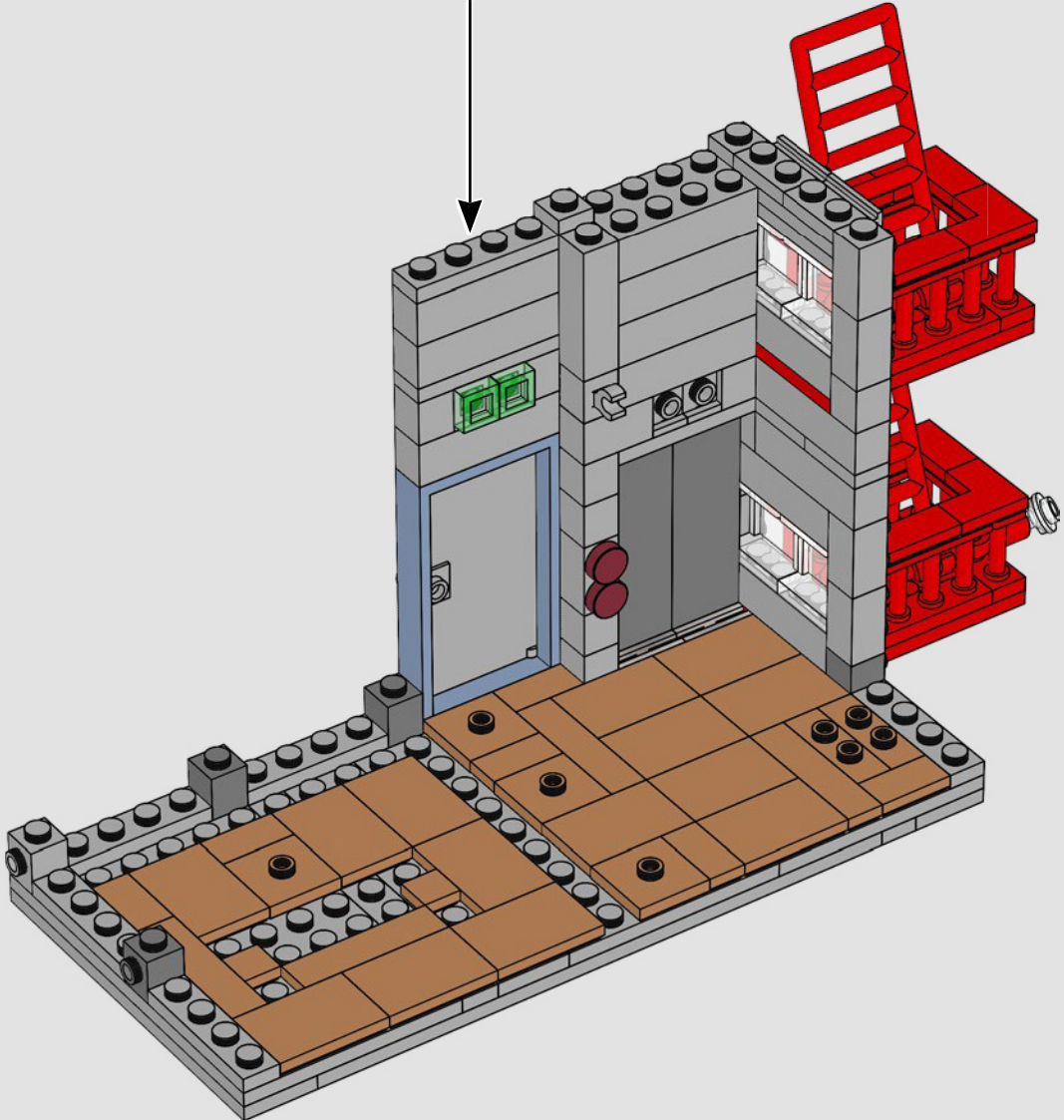
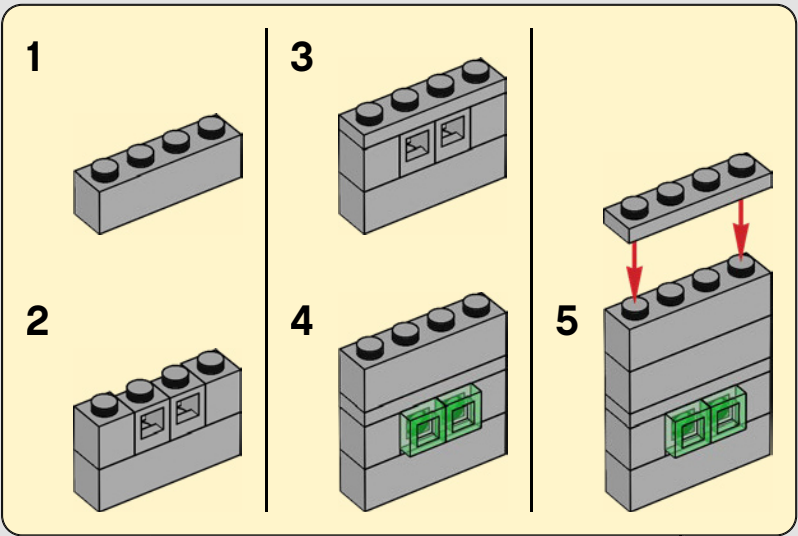



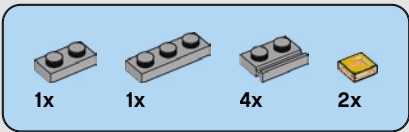

309

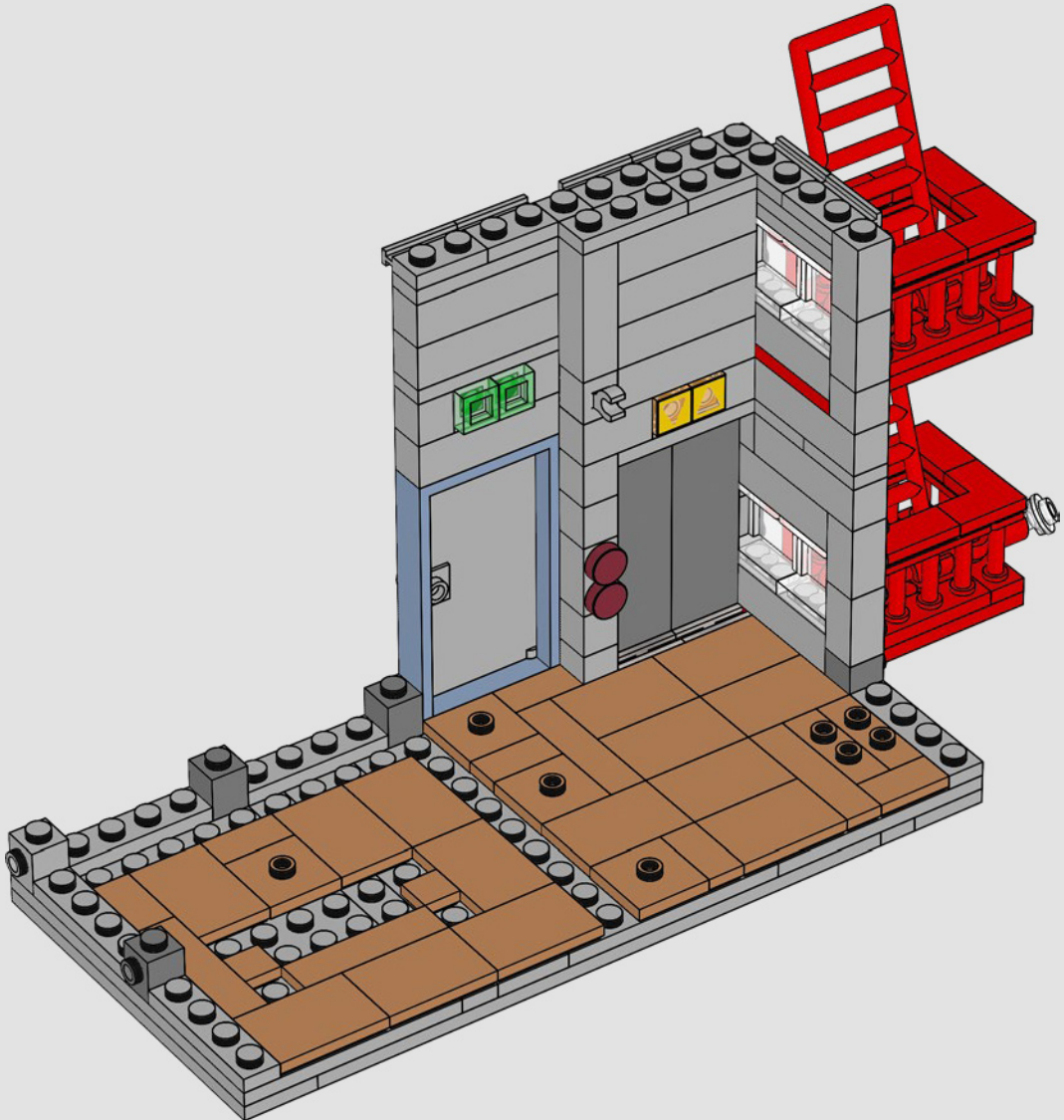

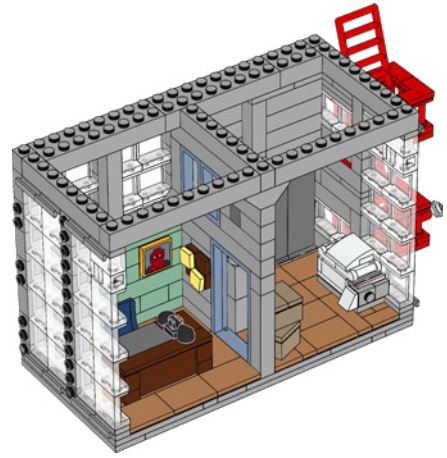
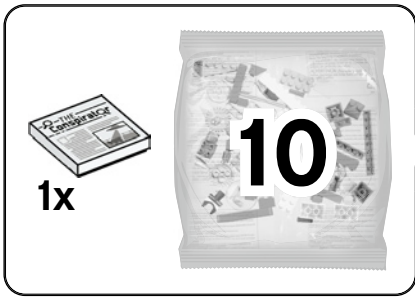

1

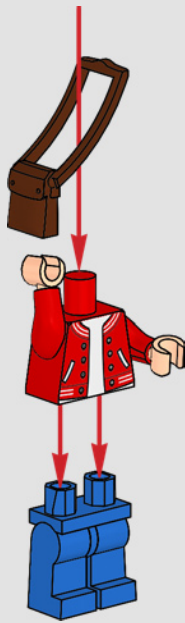

2



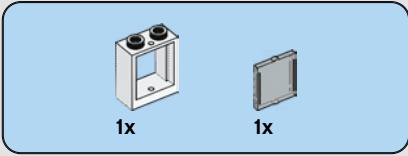
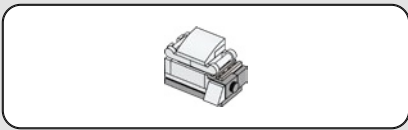

**310**

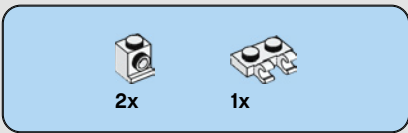
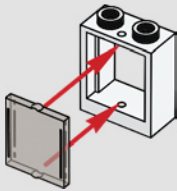

**311**

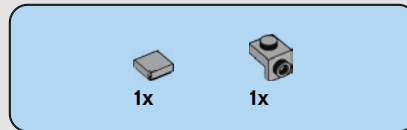
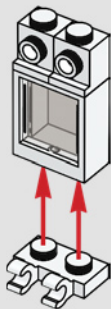

**312**

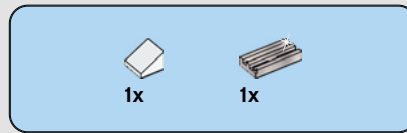
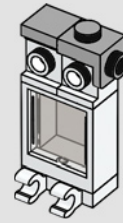

**313**

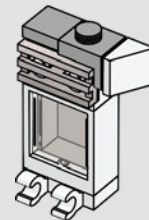



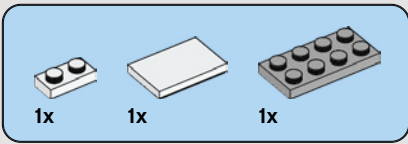

314

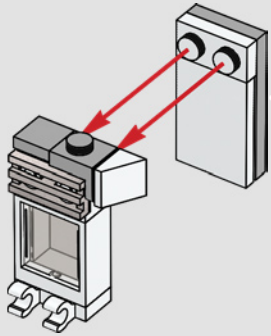
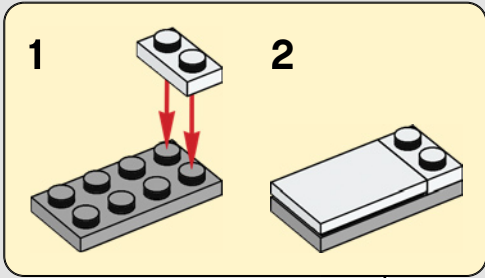

315

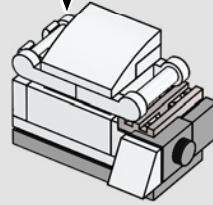
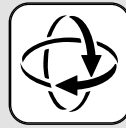
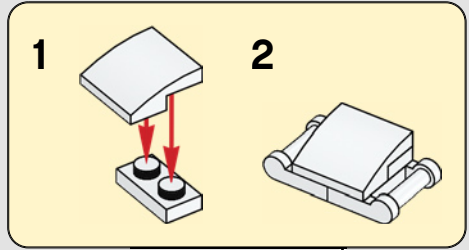

316

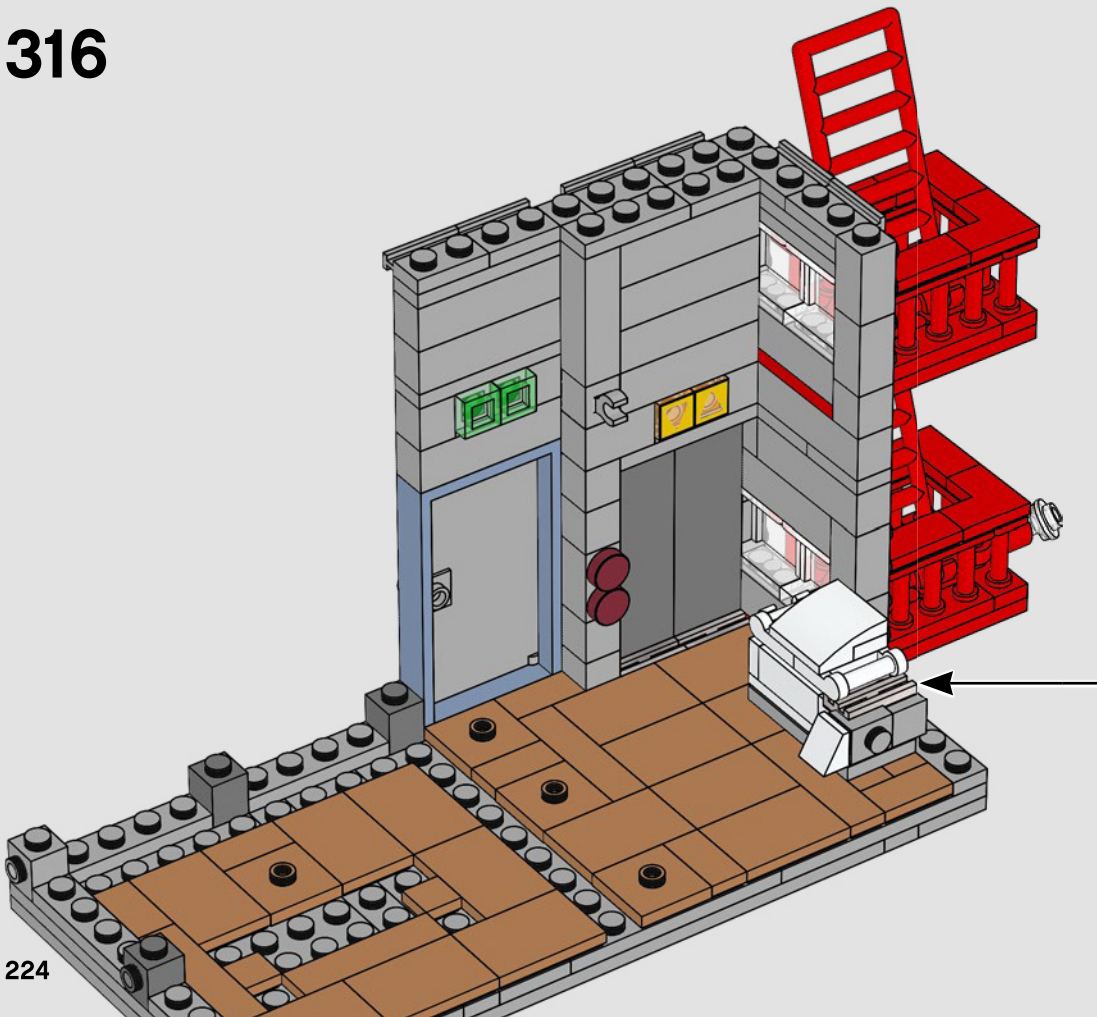

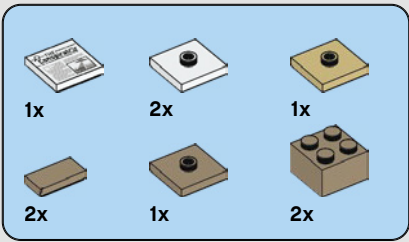

# 317

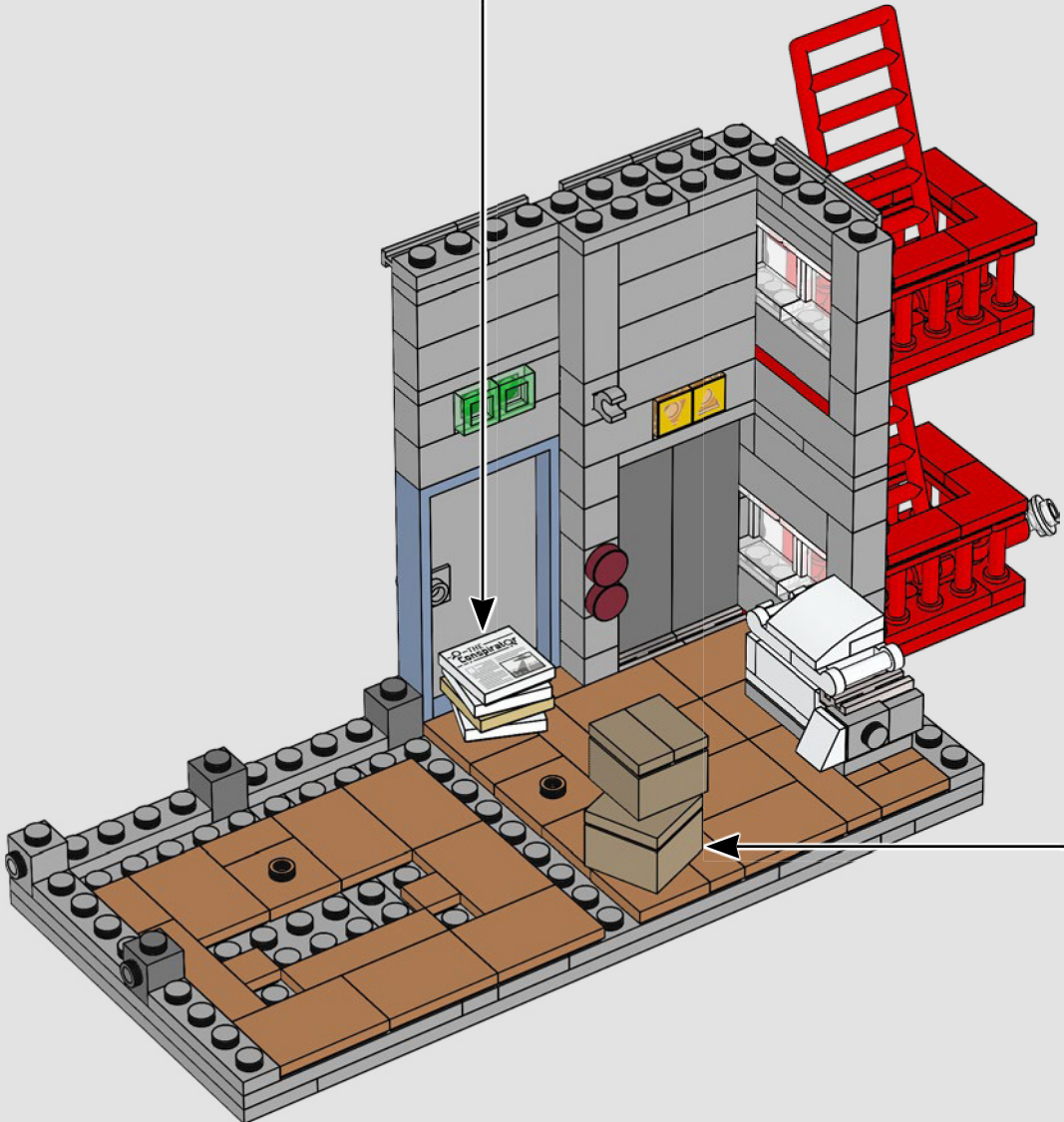
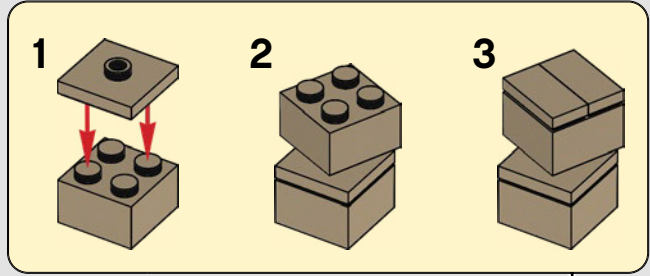
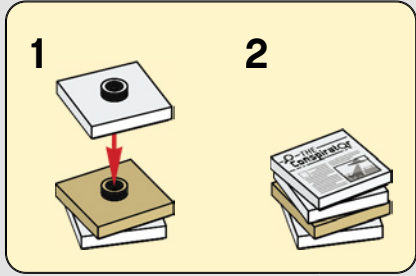

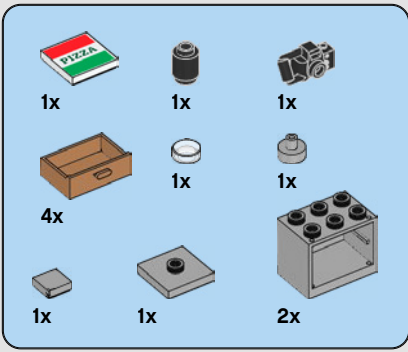

# 318

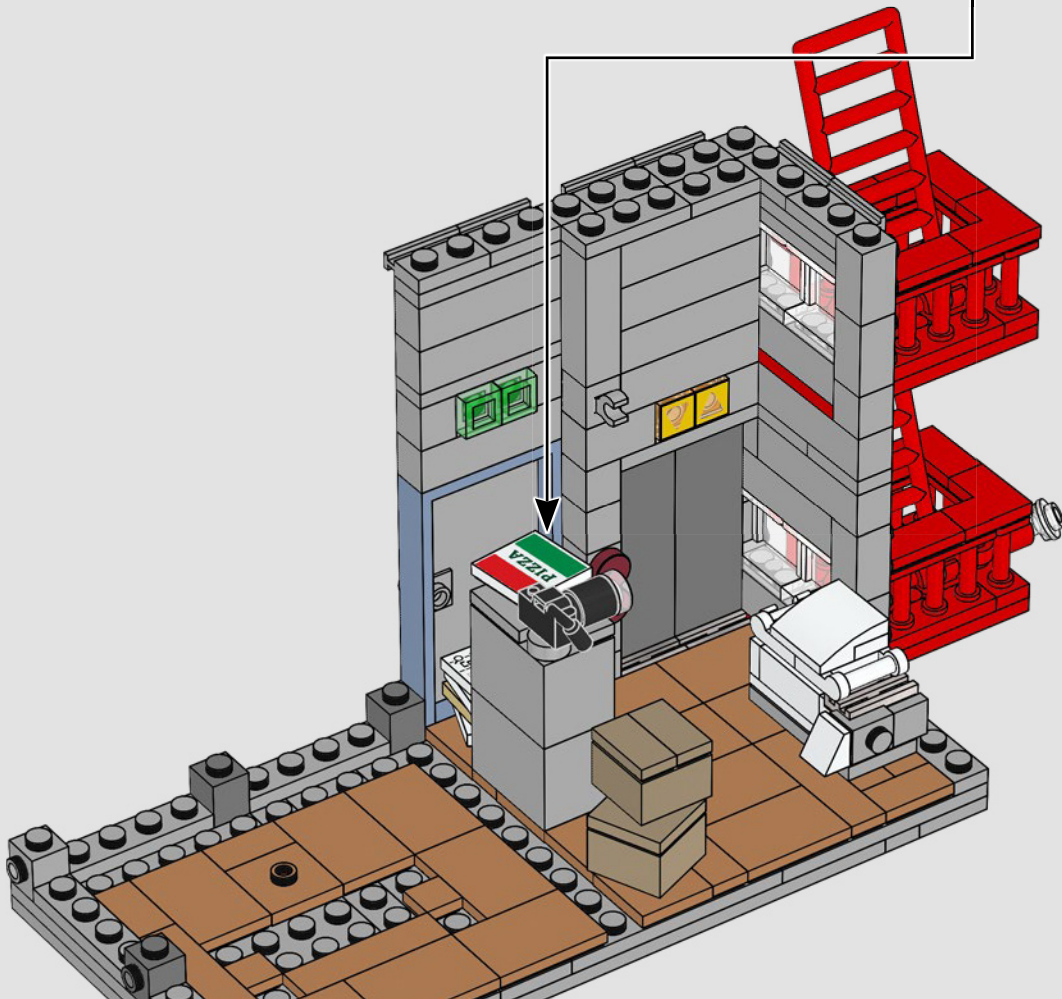
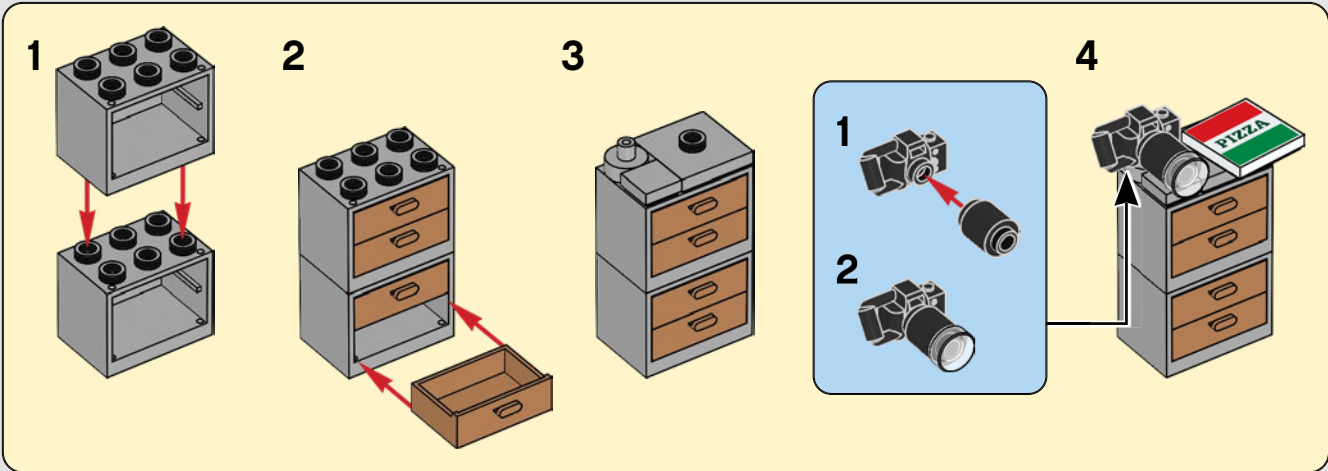



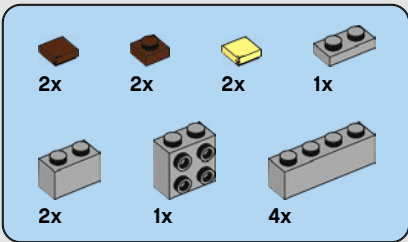

319

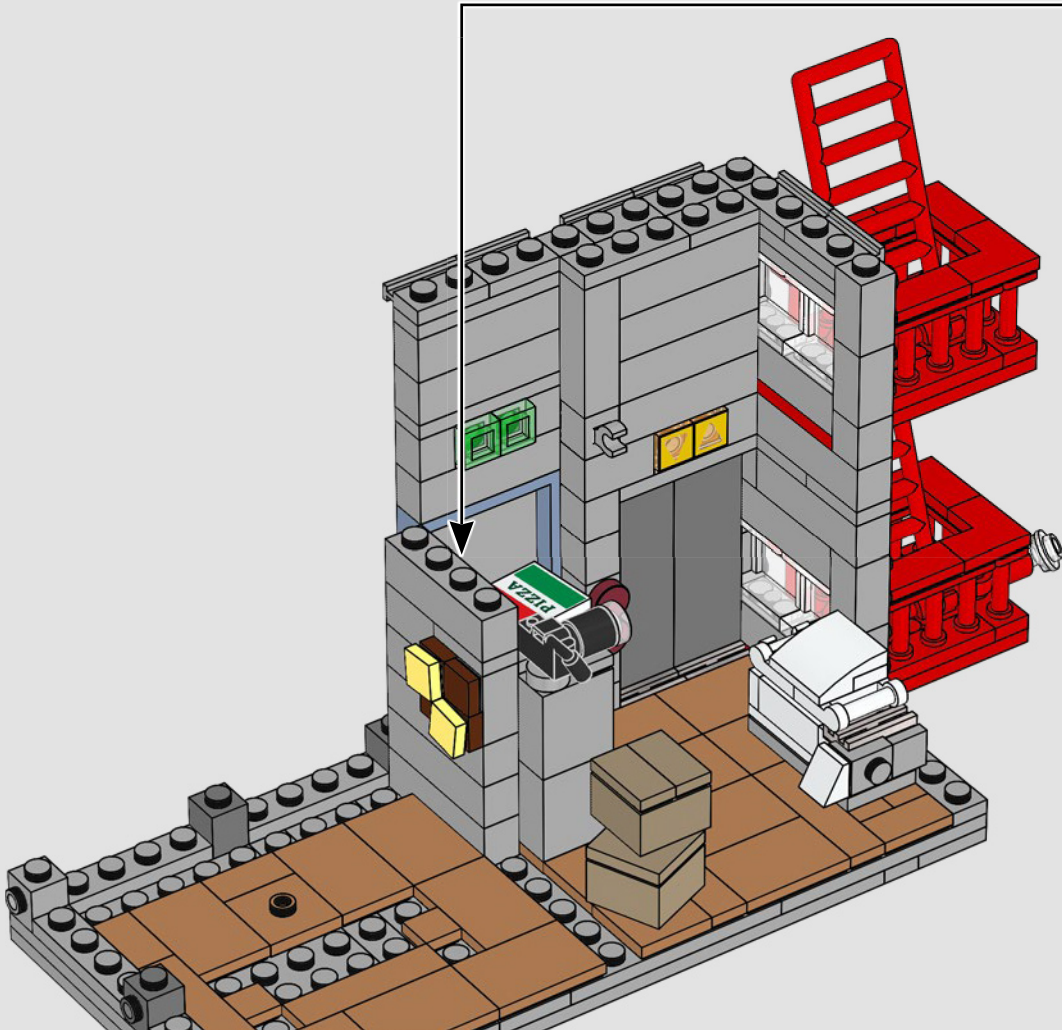
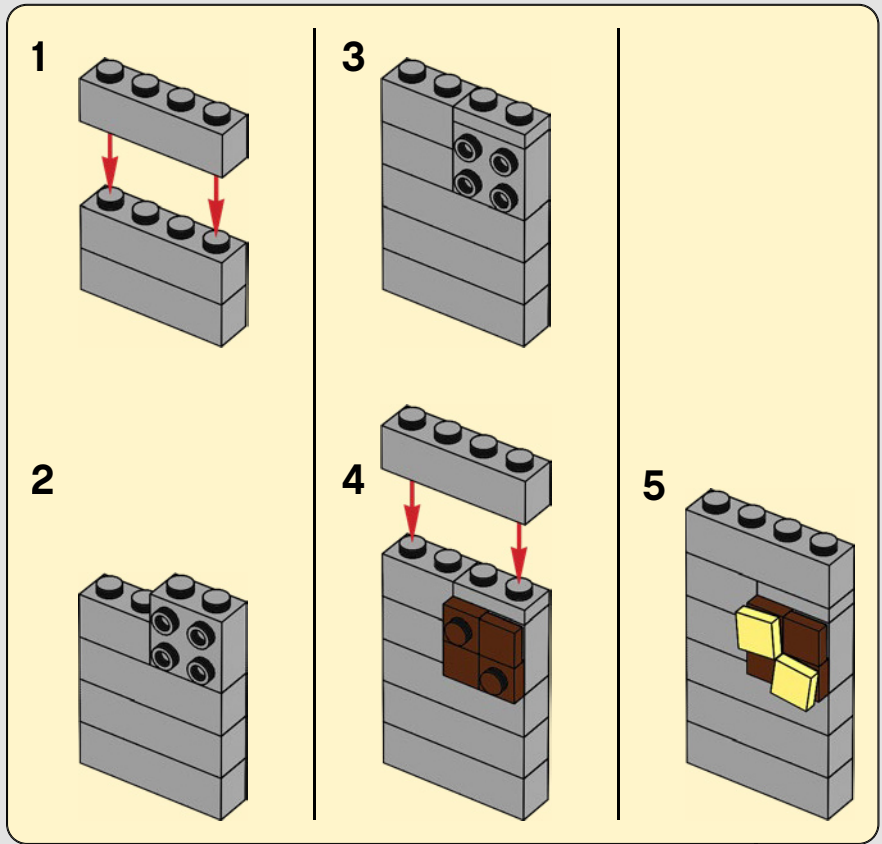

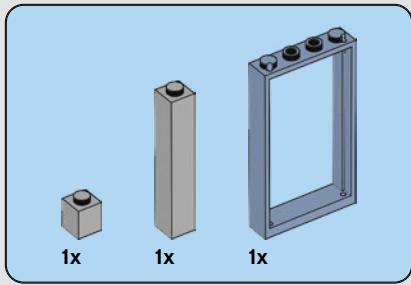

320

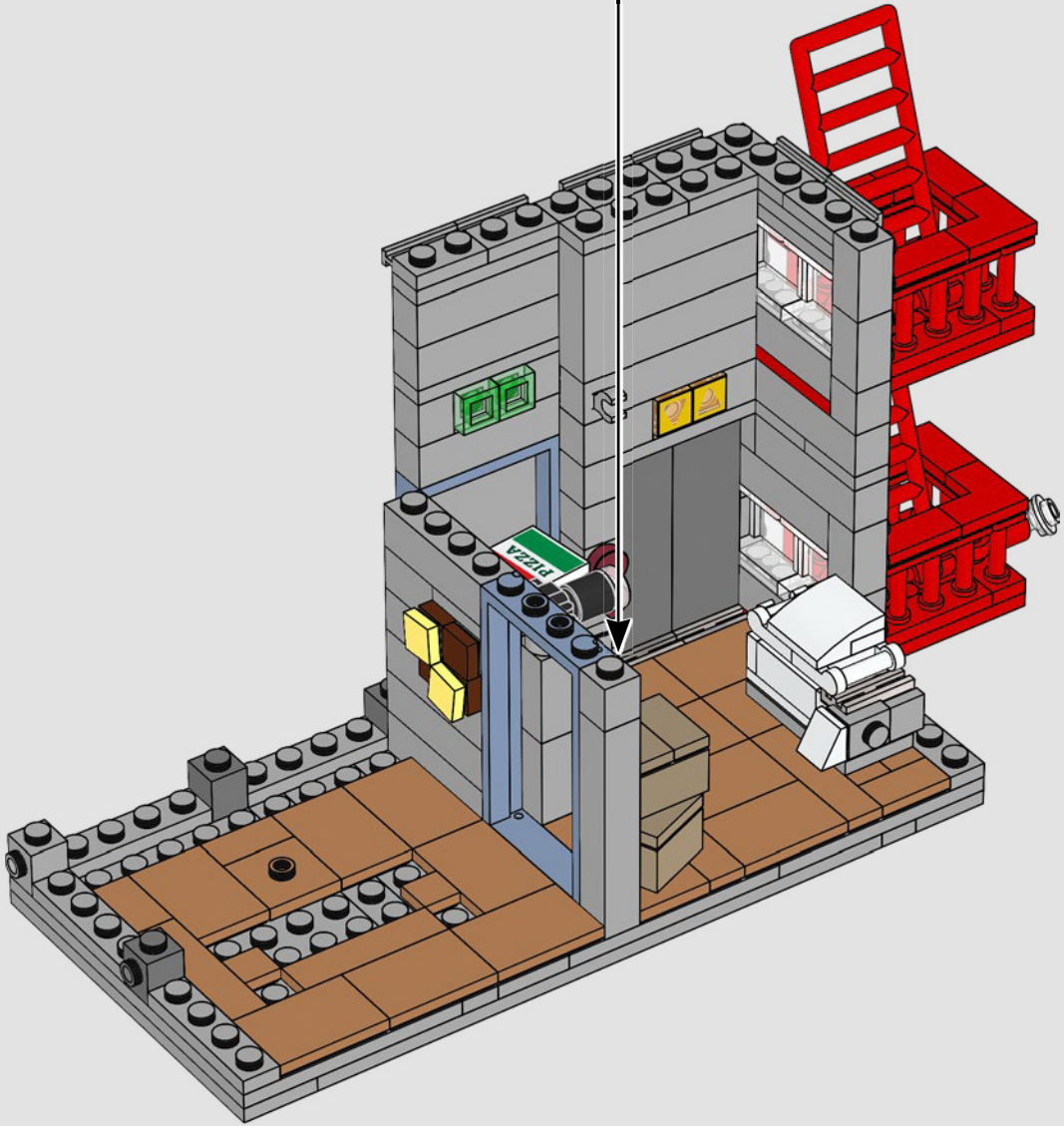
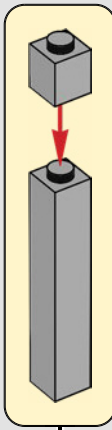

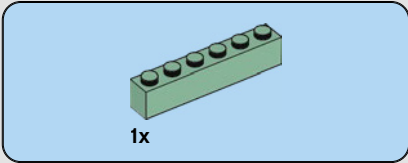
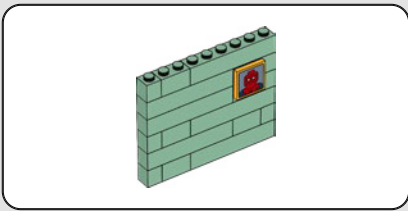

**321**

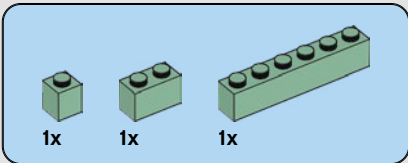
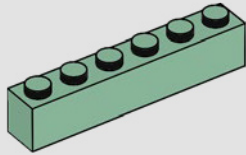

**322**

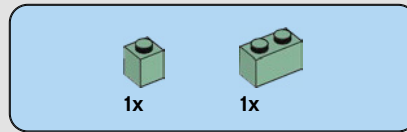
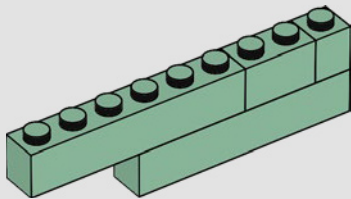

**323**

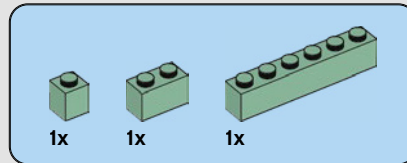
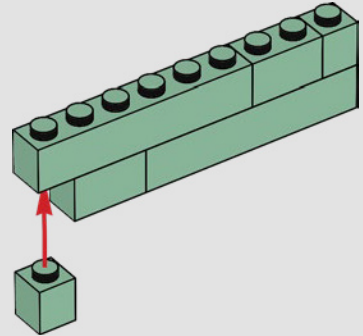

**324**

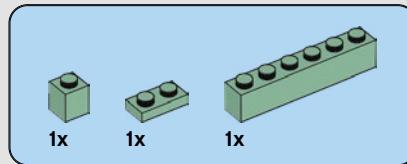
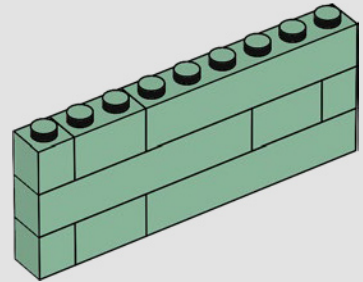

**325**

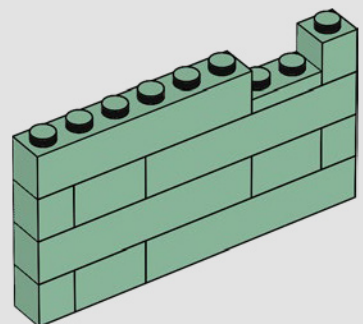



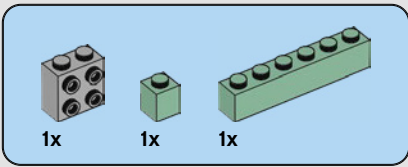

326

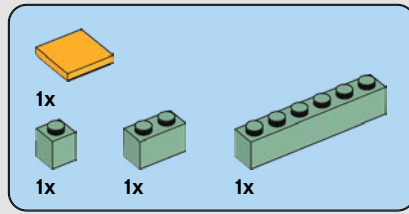
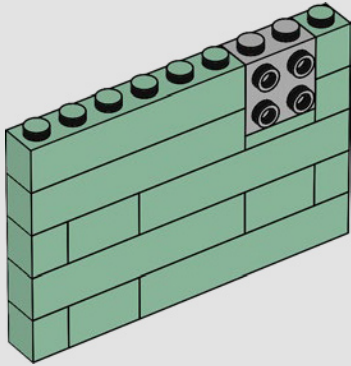

327

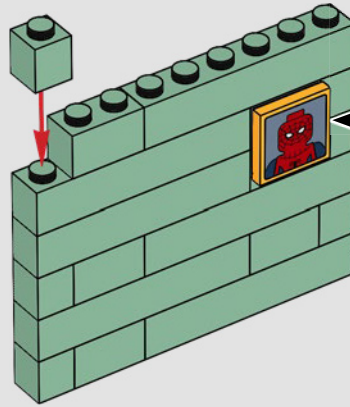

328

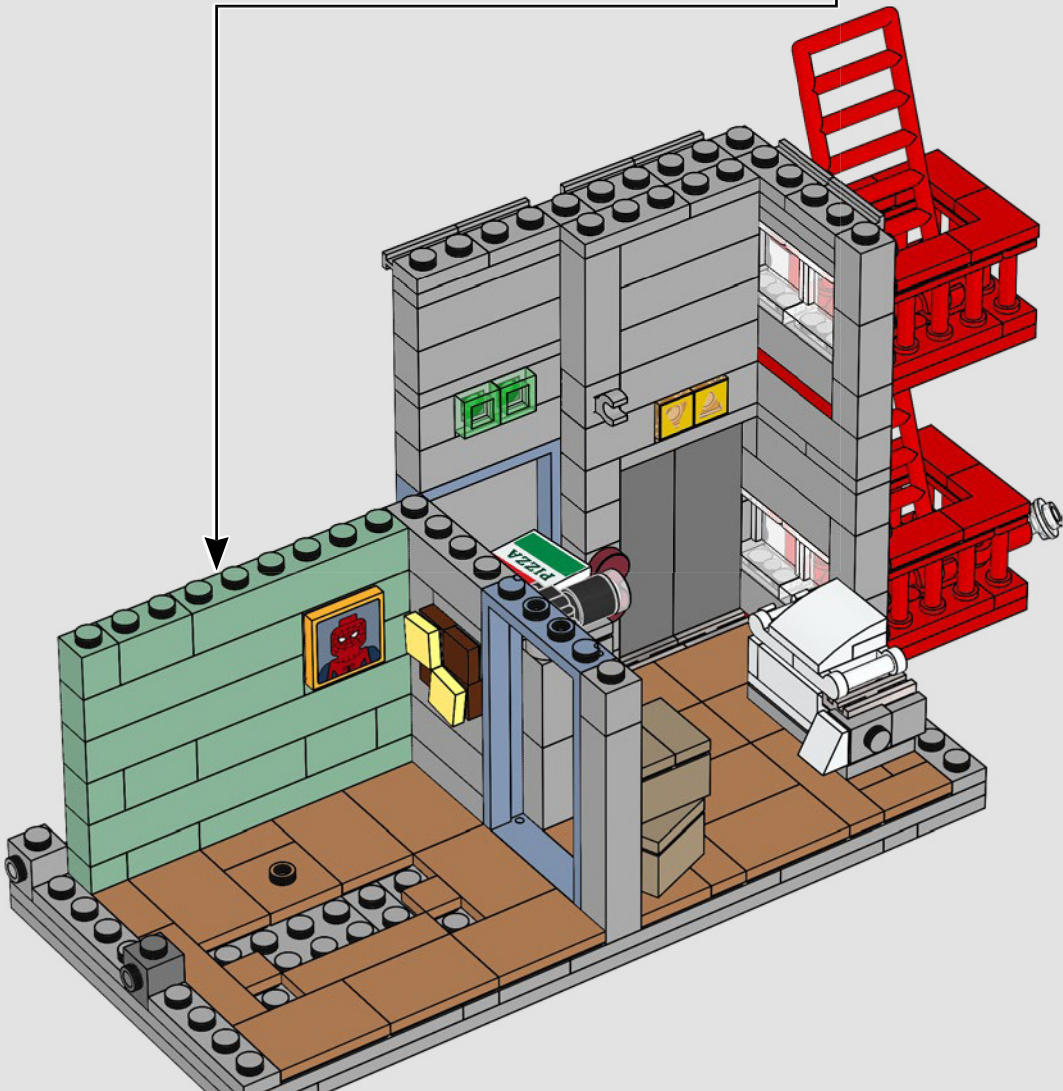

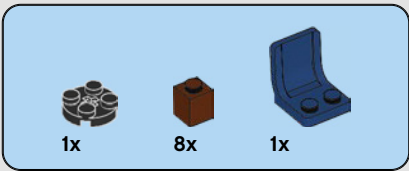

329

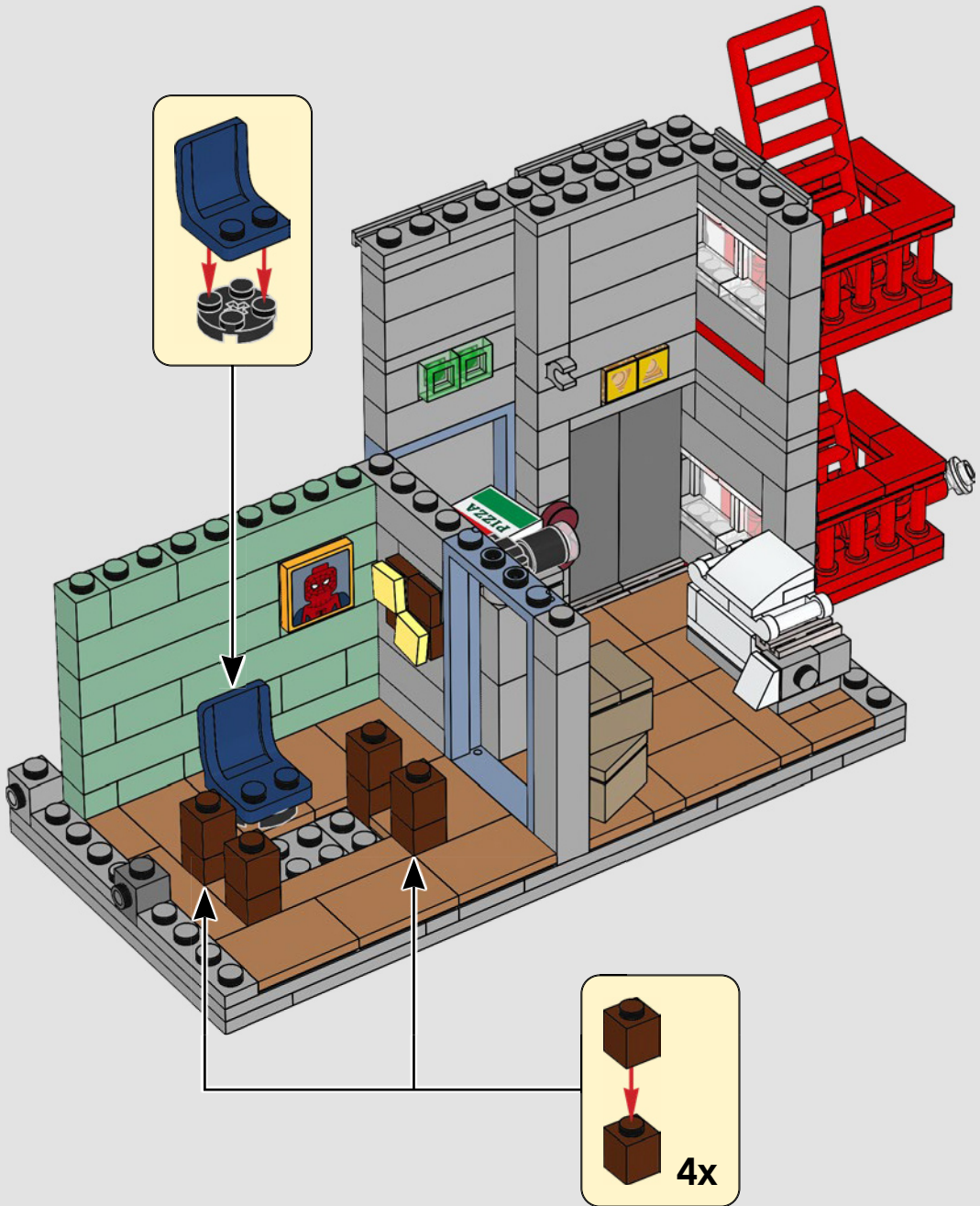

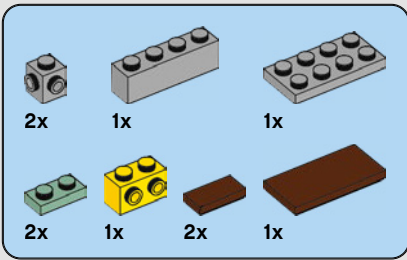

# 330

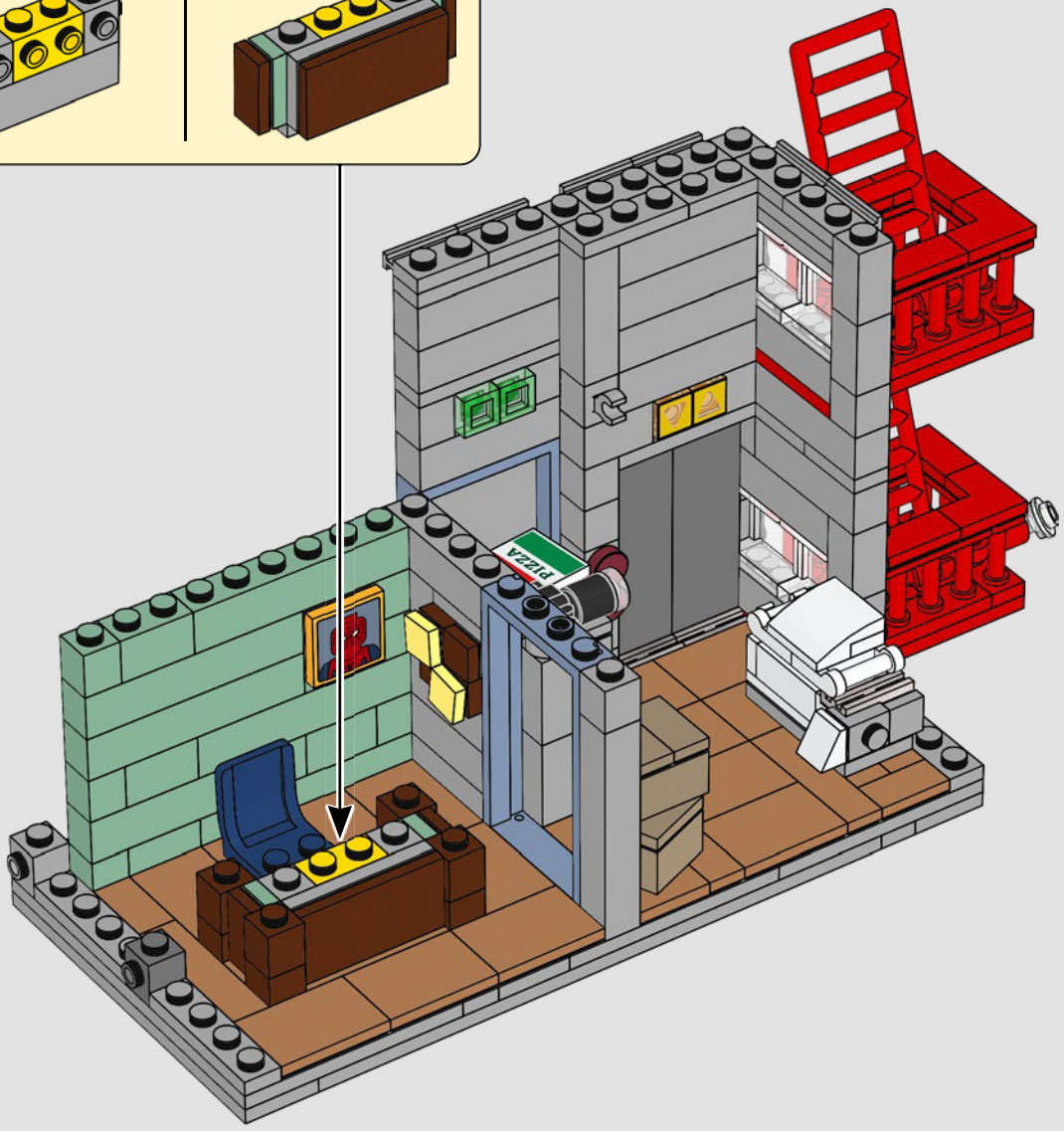
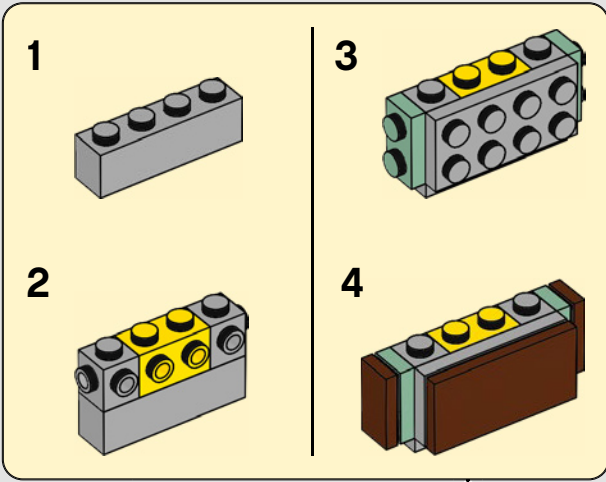



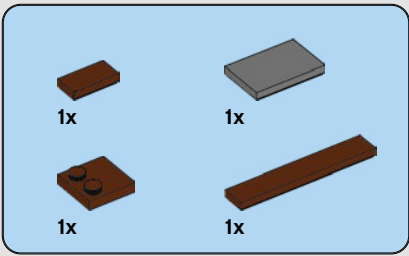

# 331

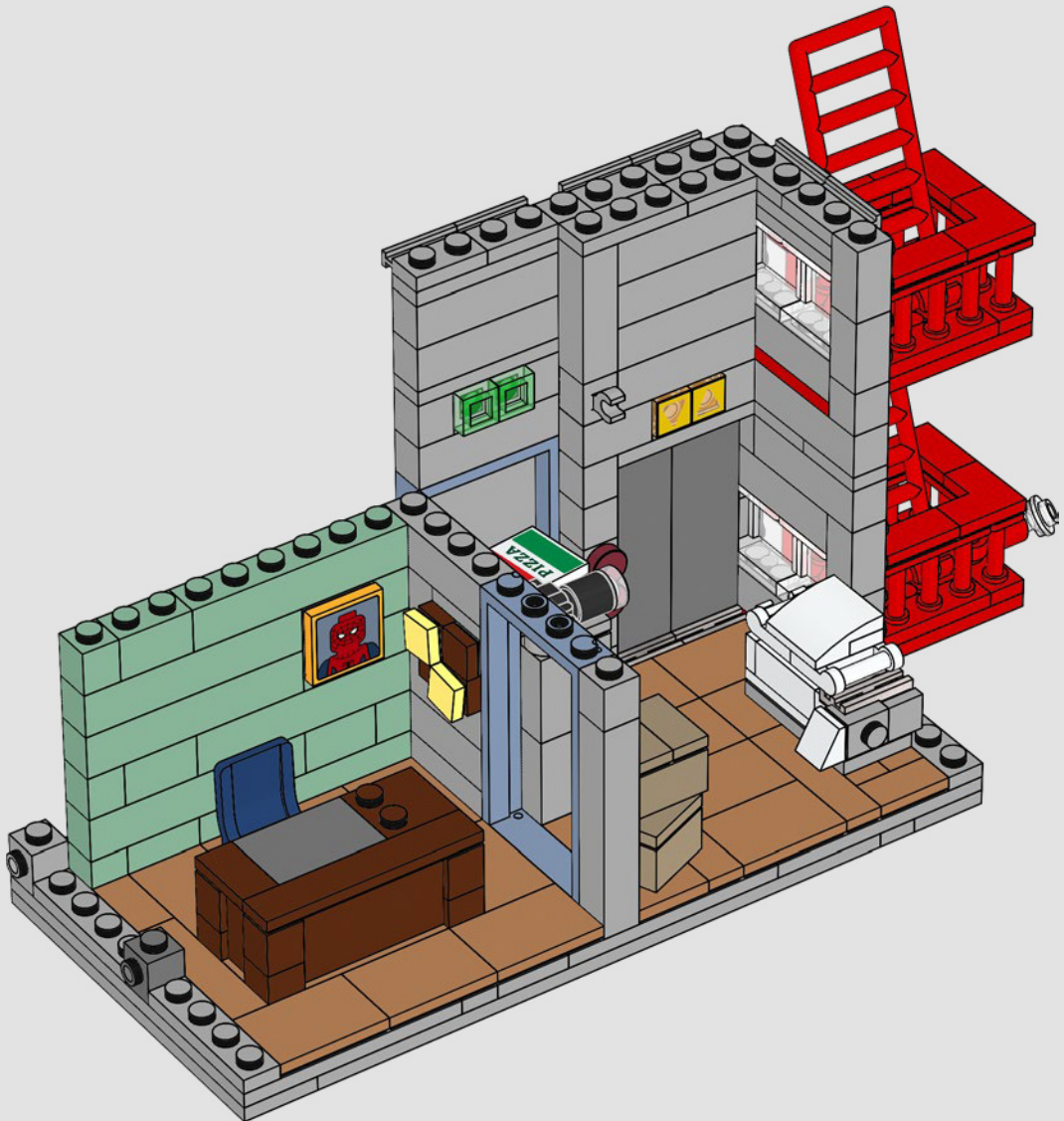

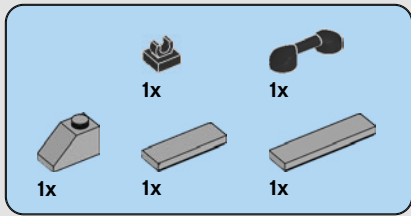

332

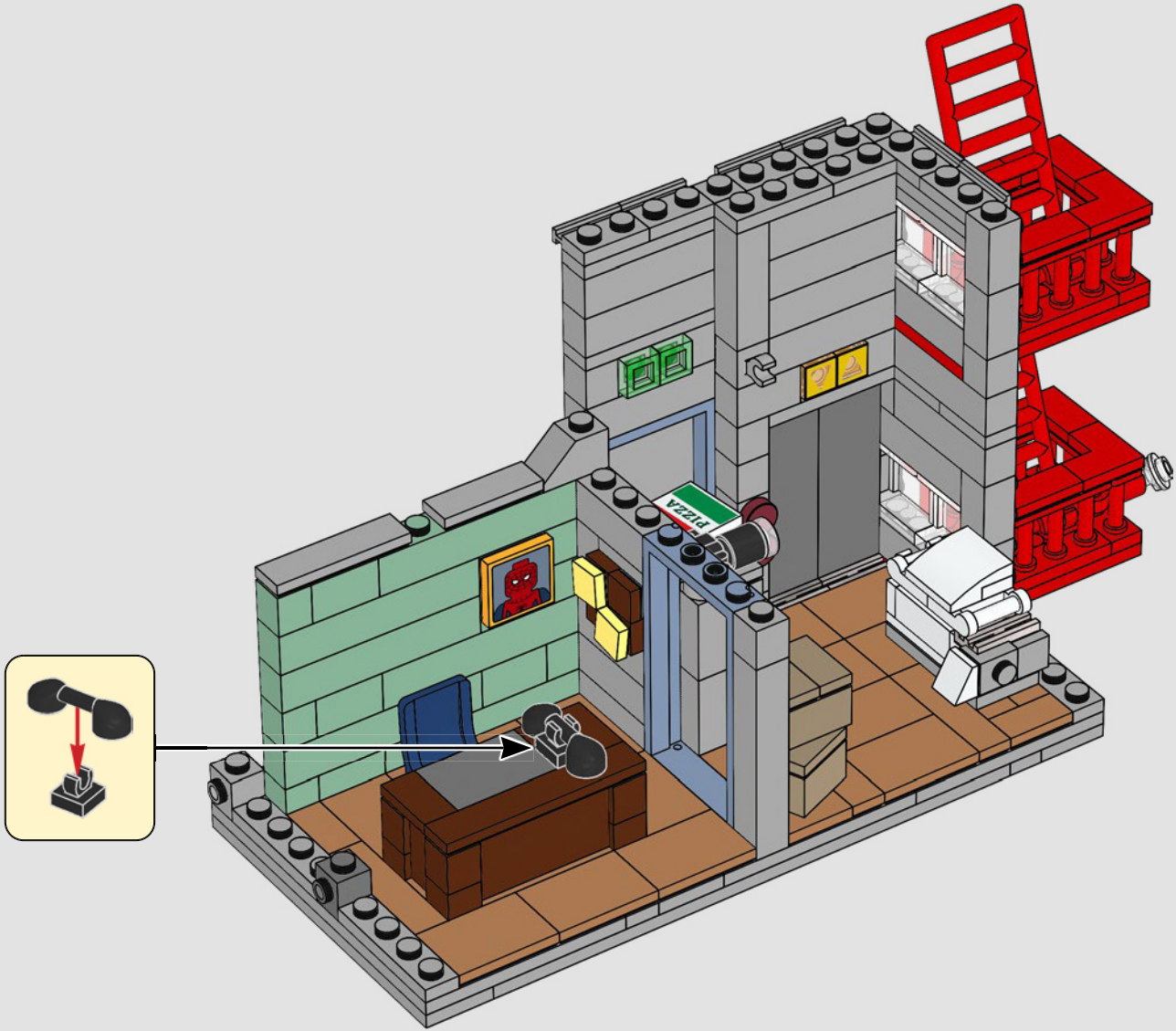

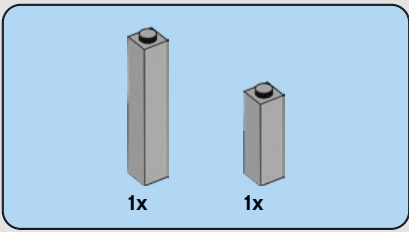

333

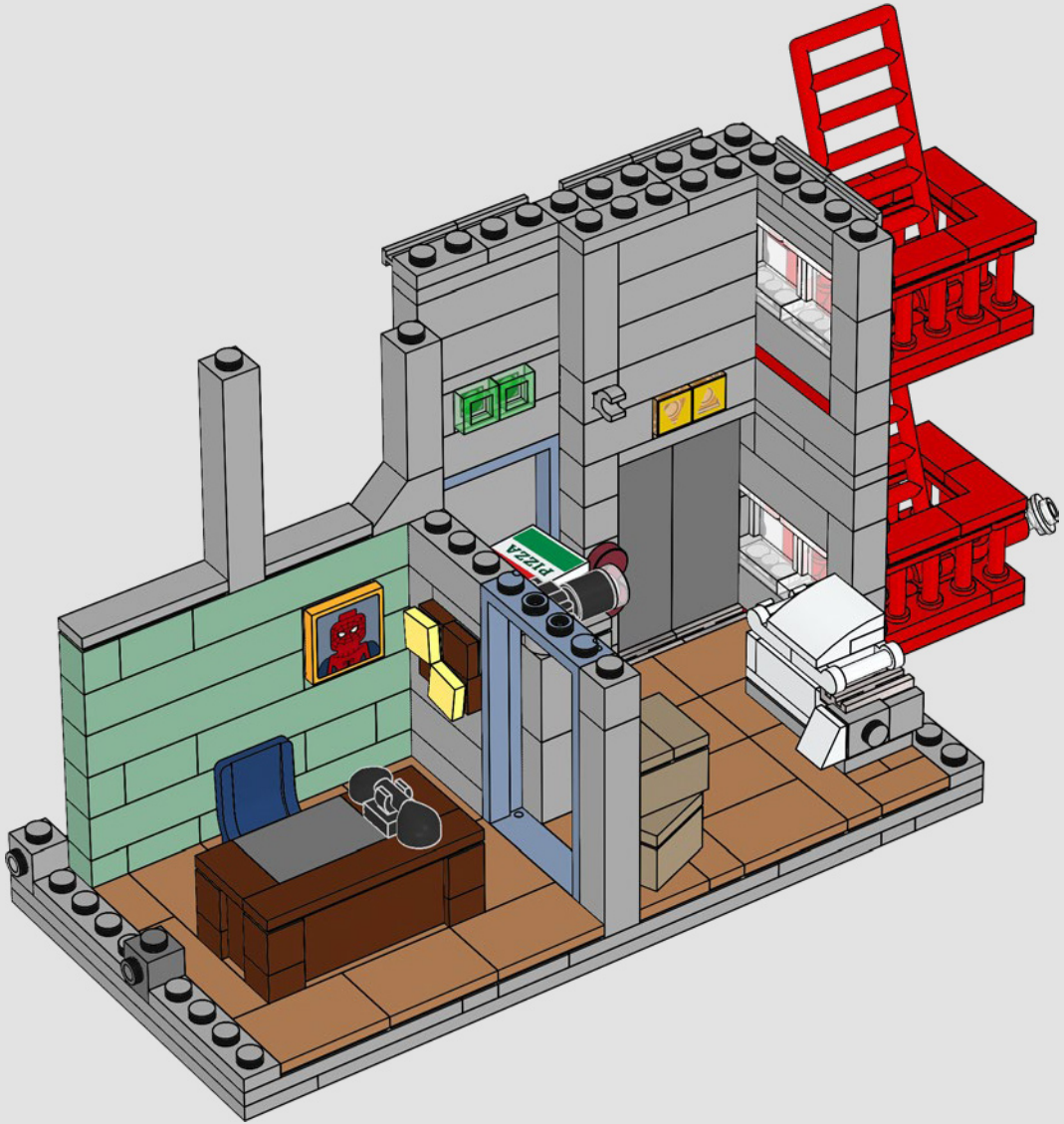



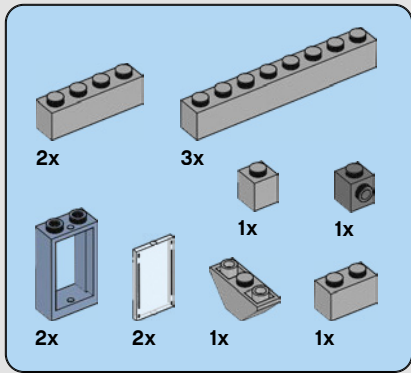

# 334

1

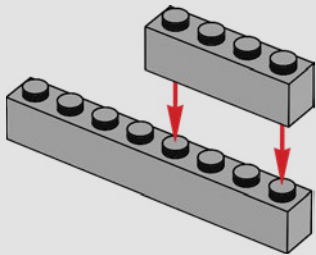

2

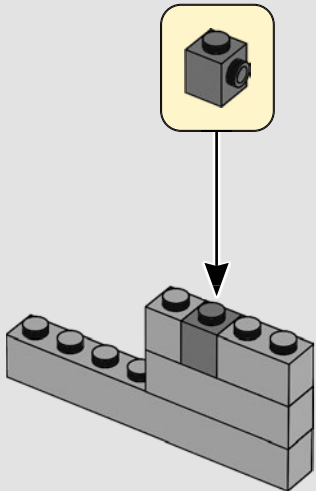

3

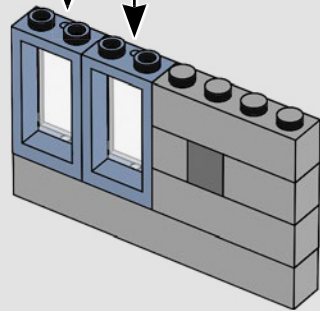

4

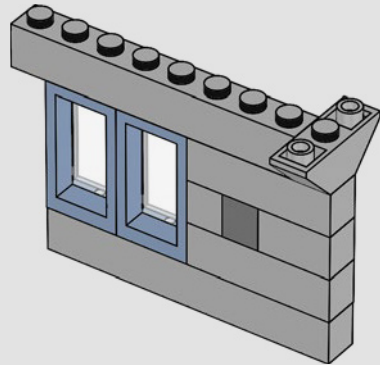

5

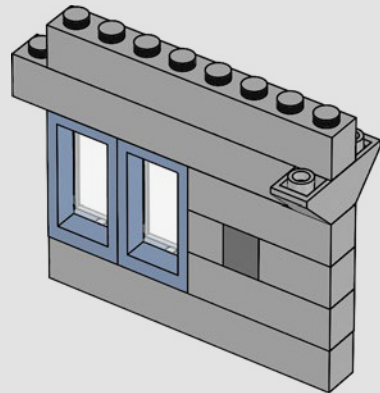

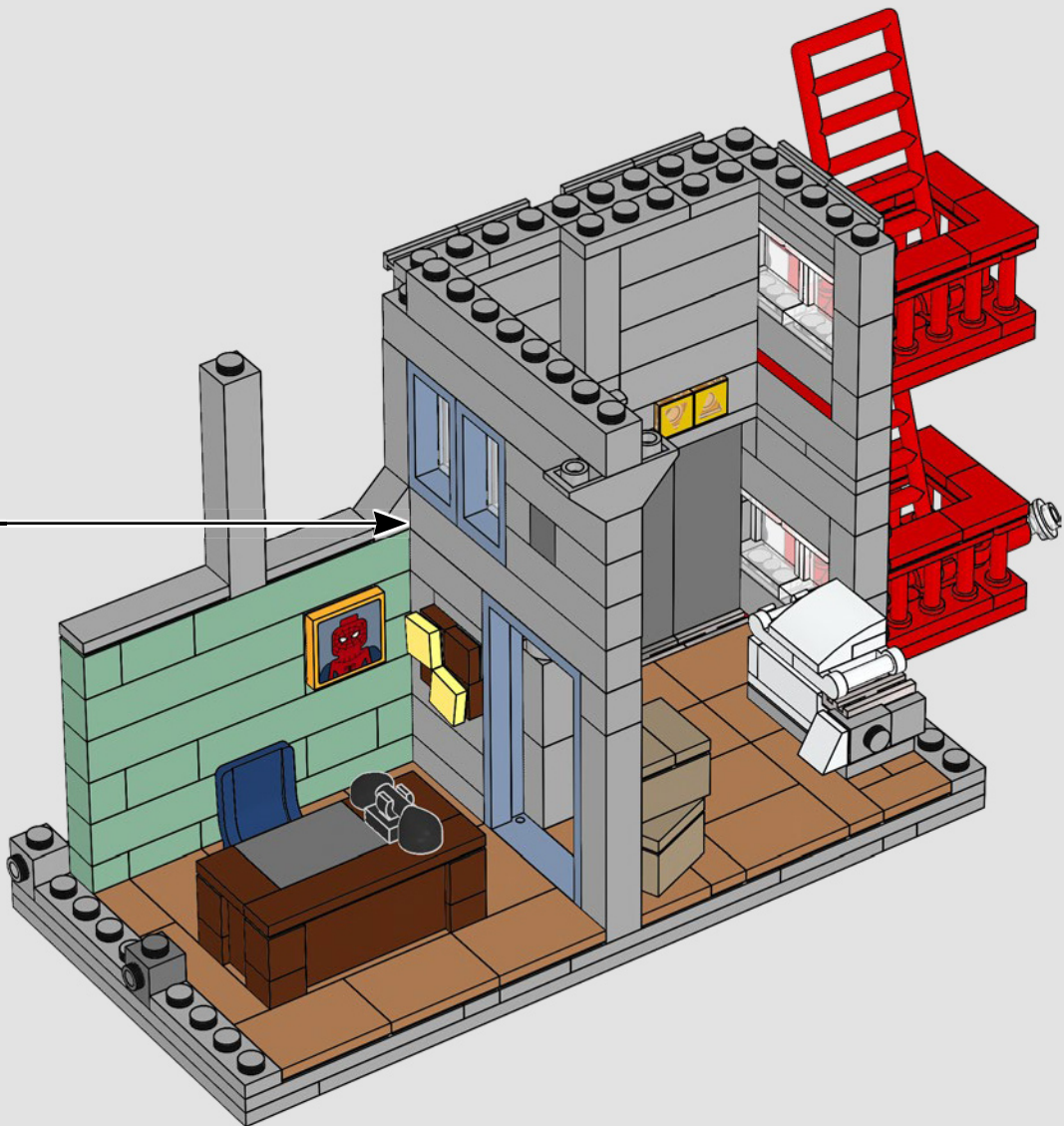



24x

# 335

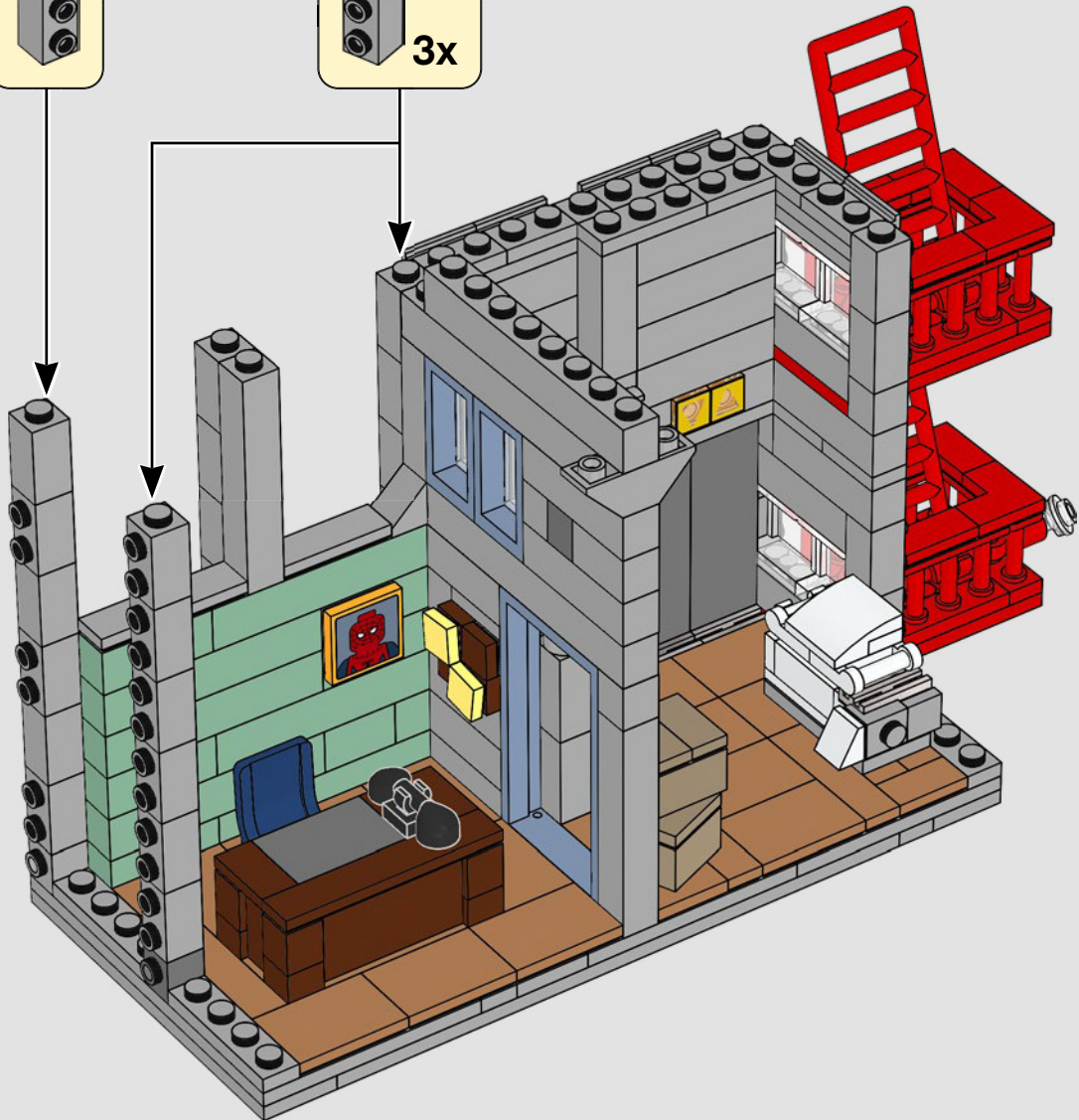
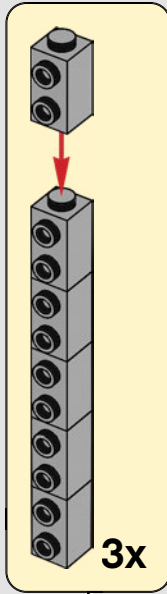
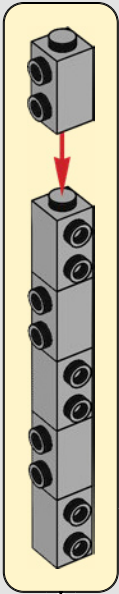



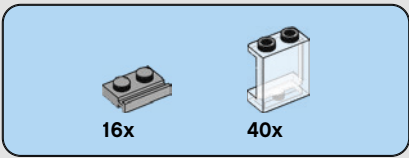

# 336

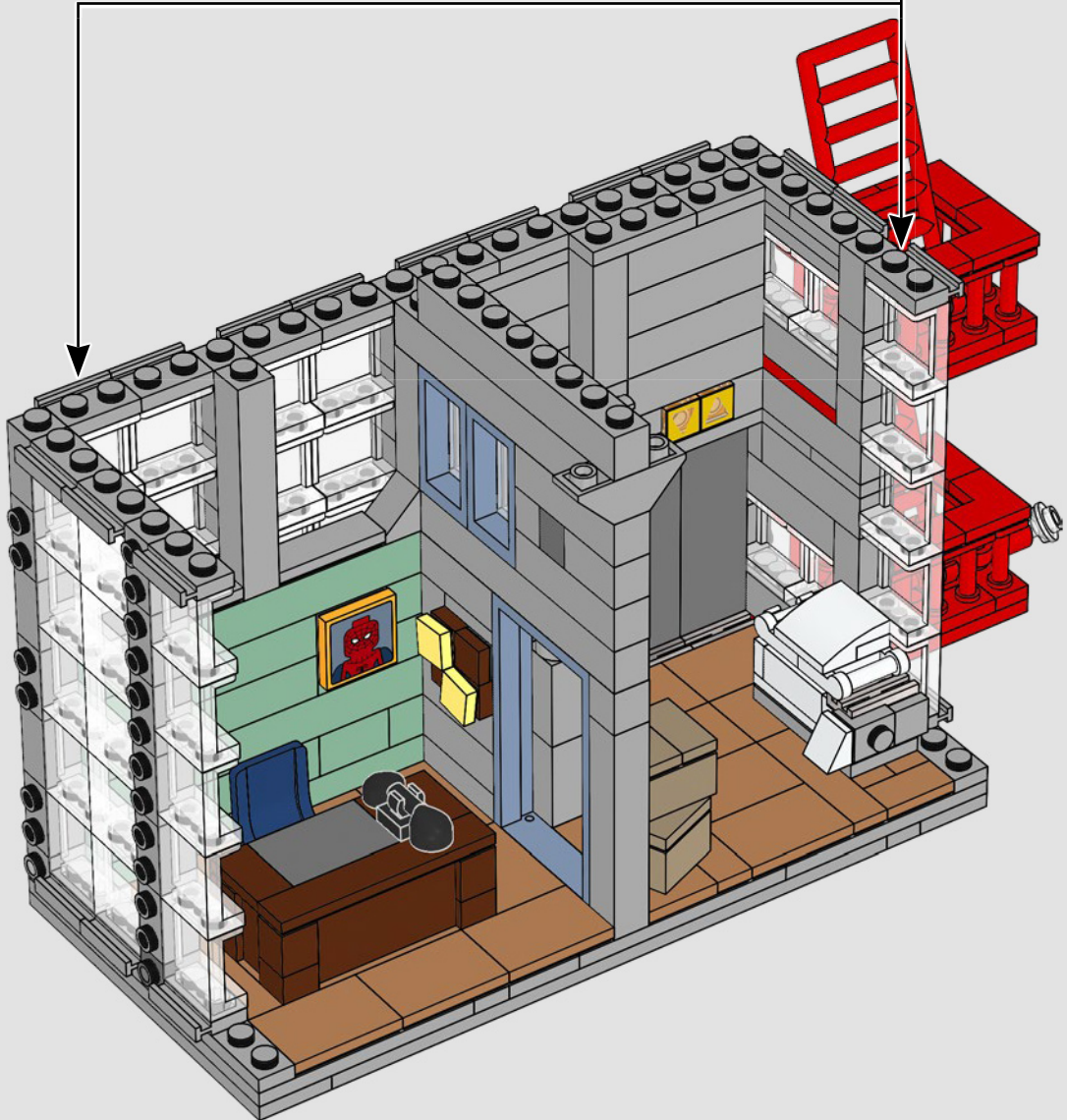
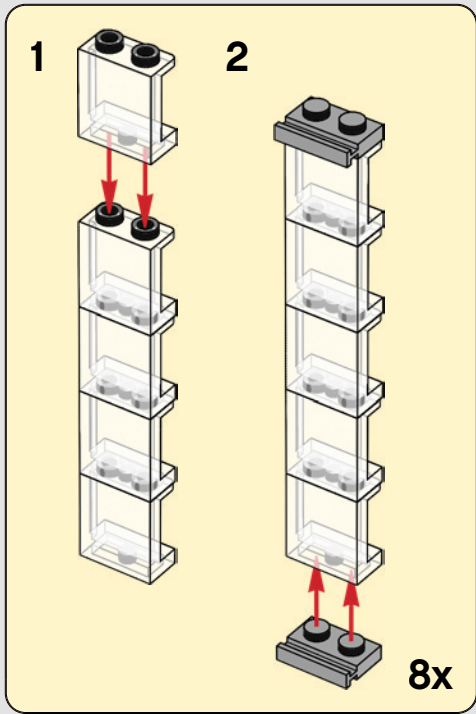

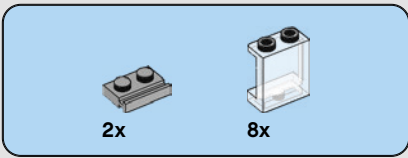

# 337

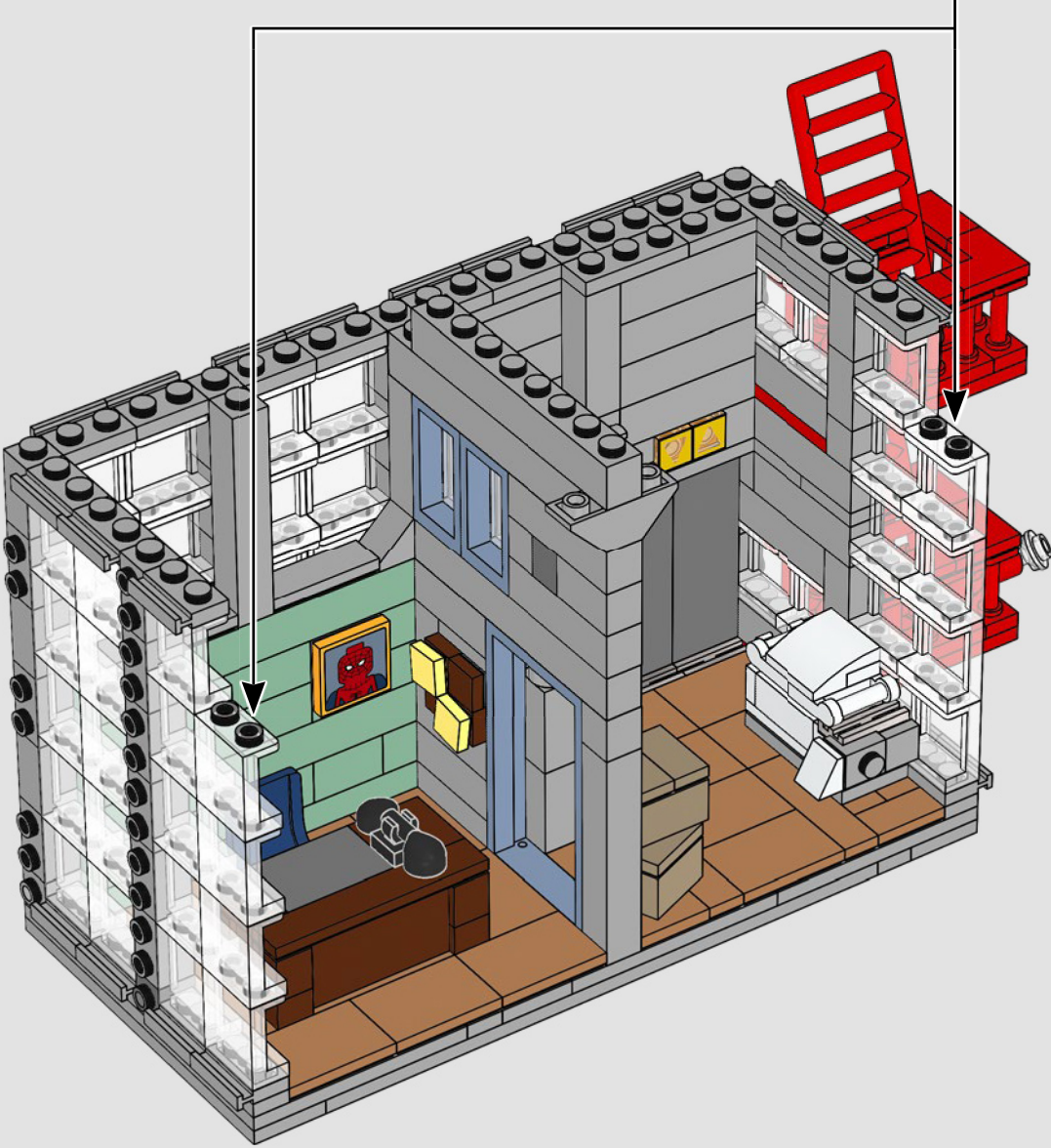
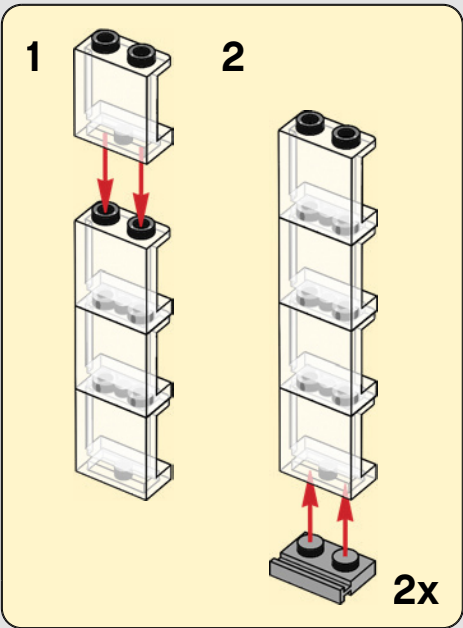



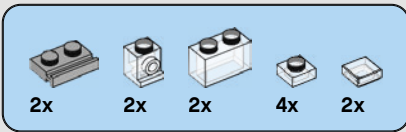

# 338

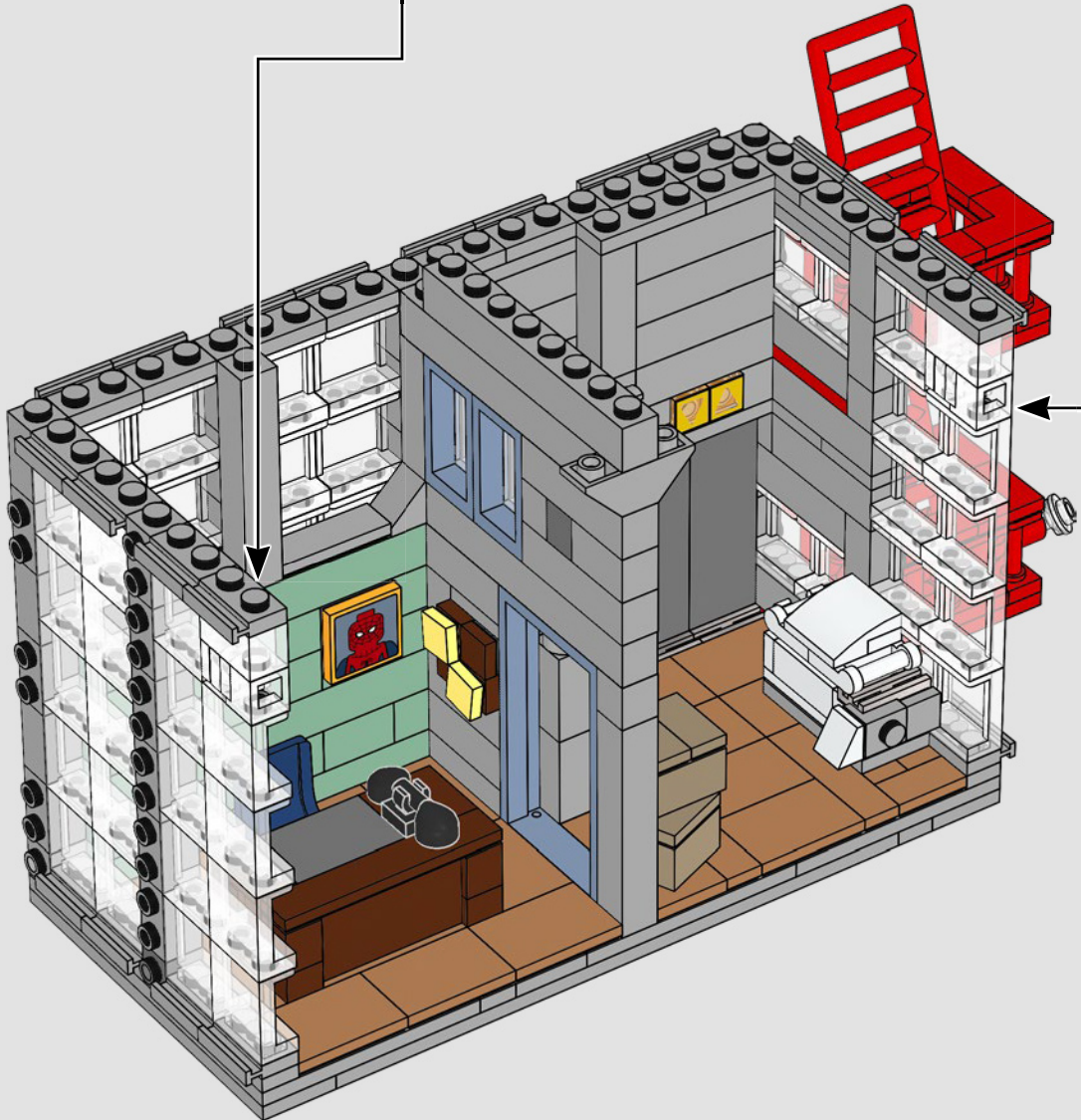
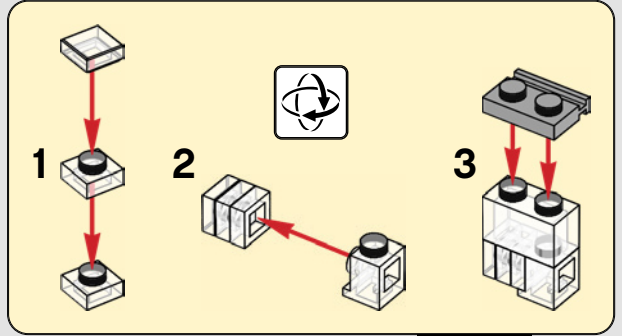
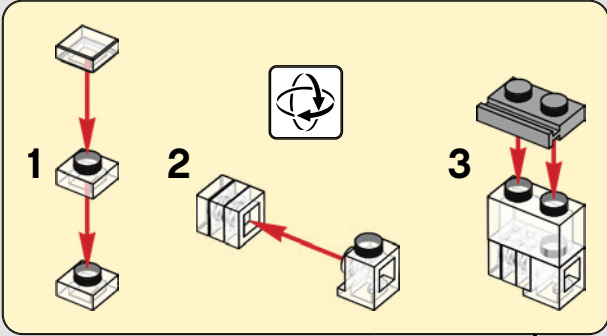



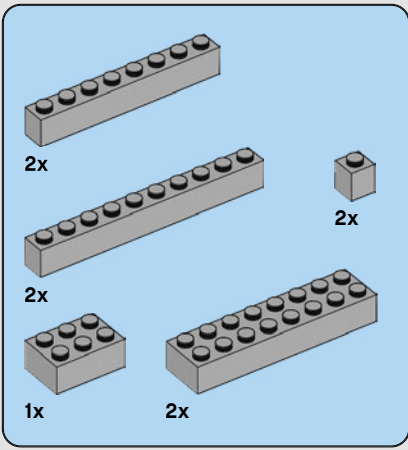

339

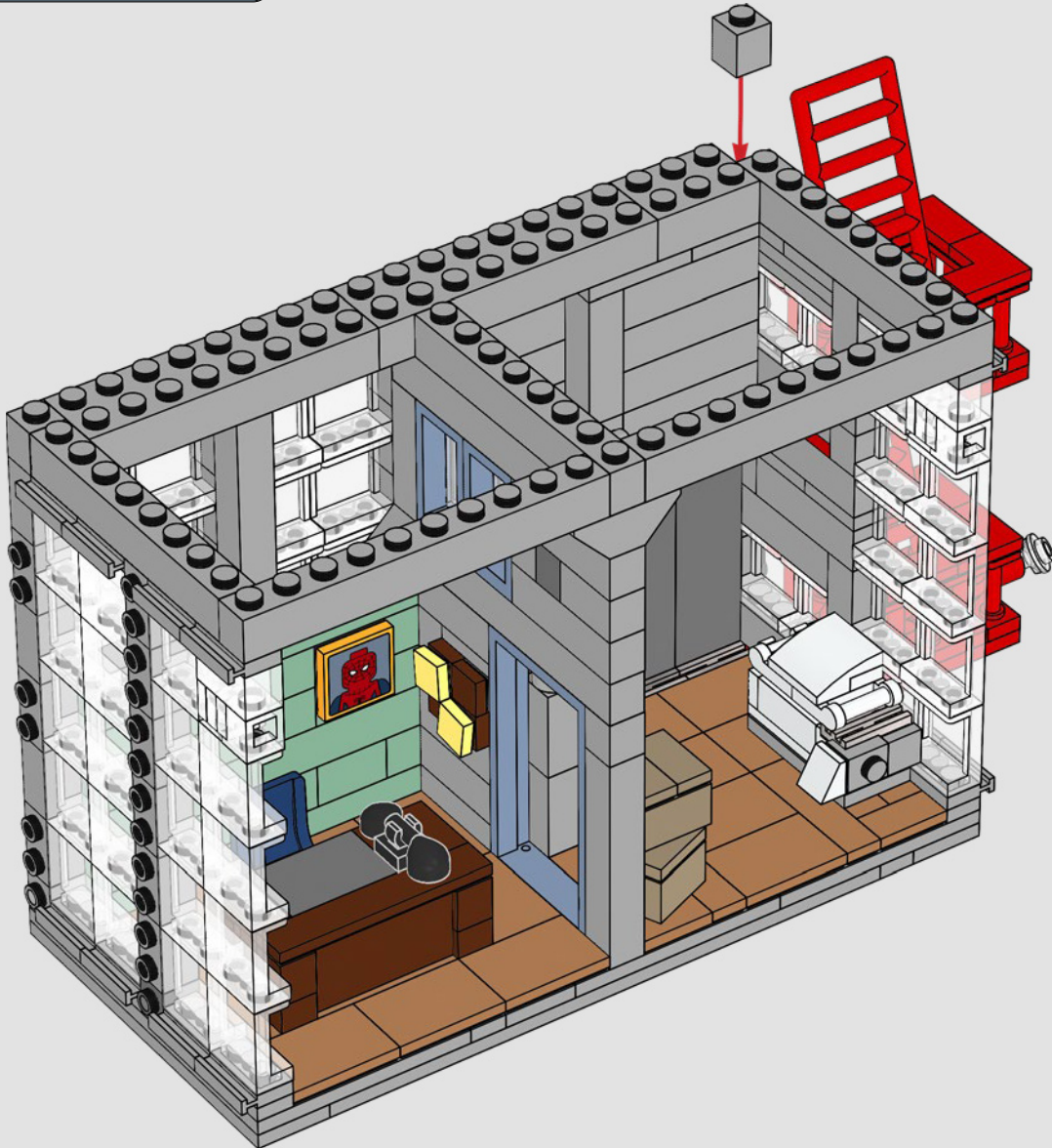

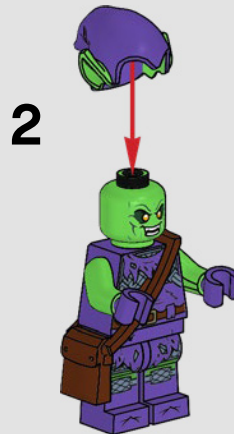
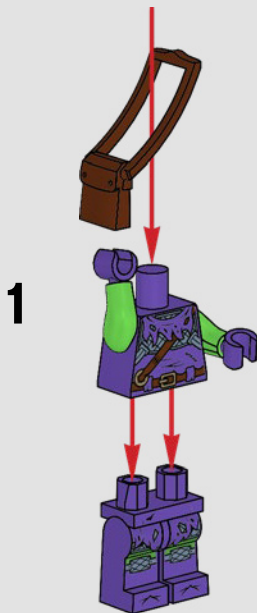
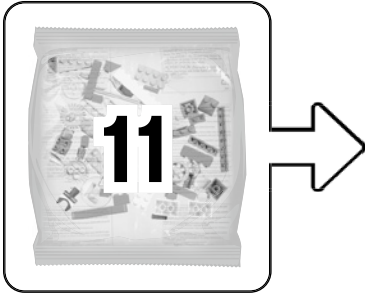

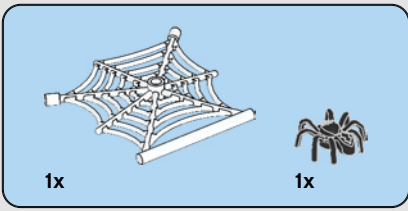

340





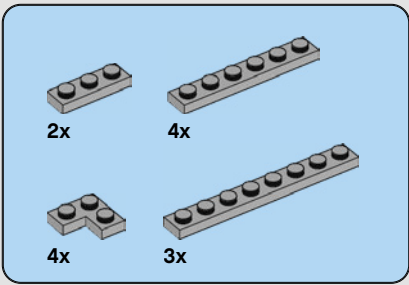

# 341

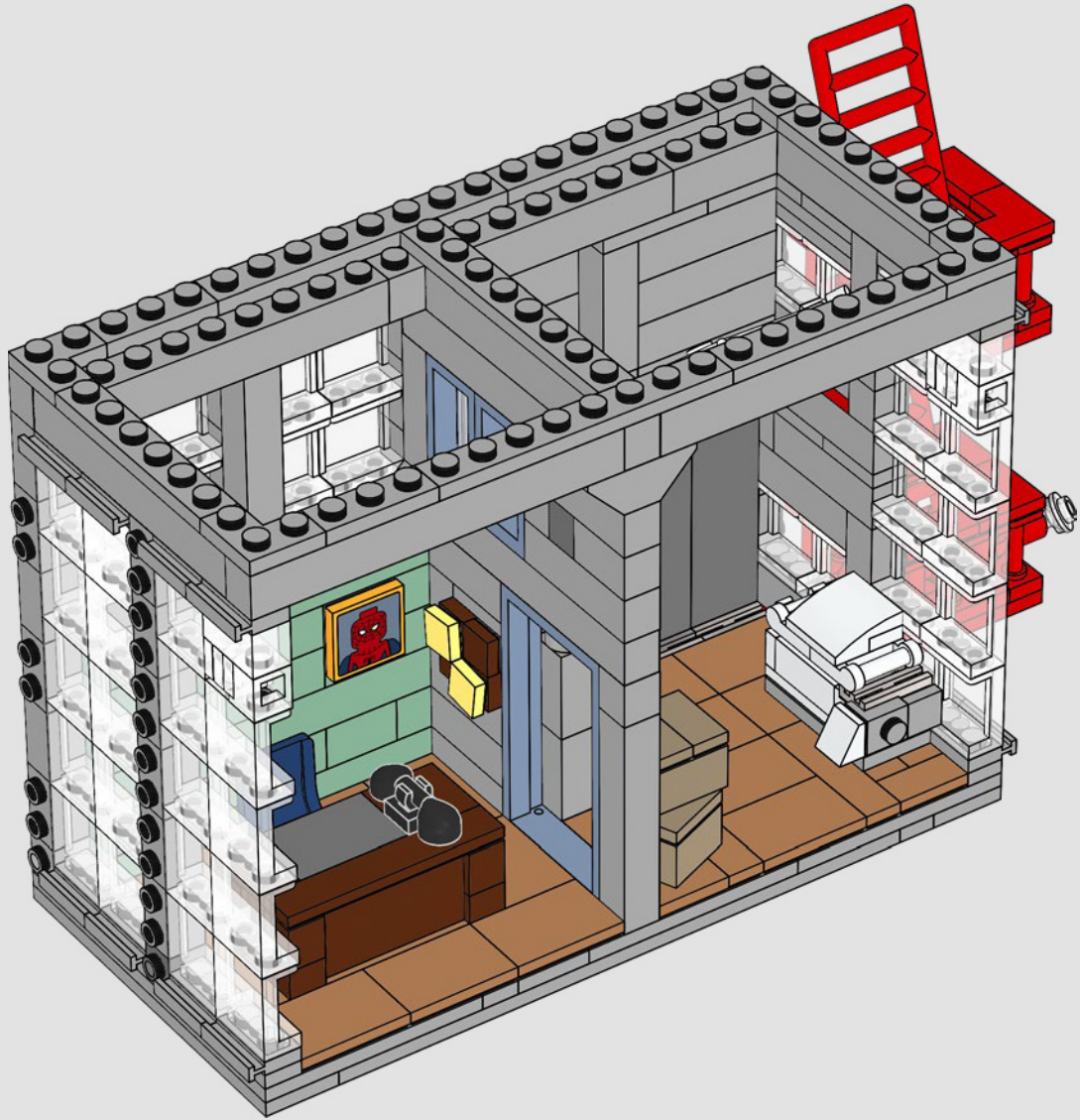

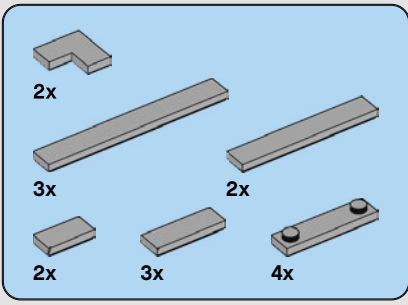

# 342

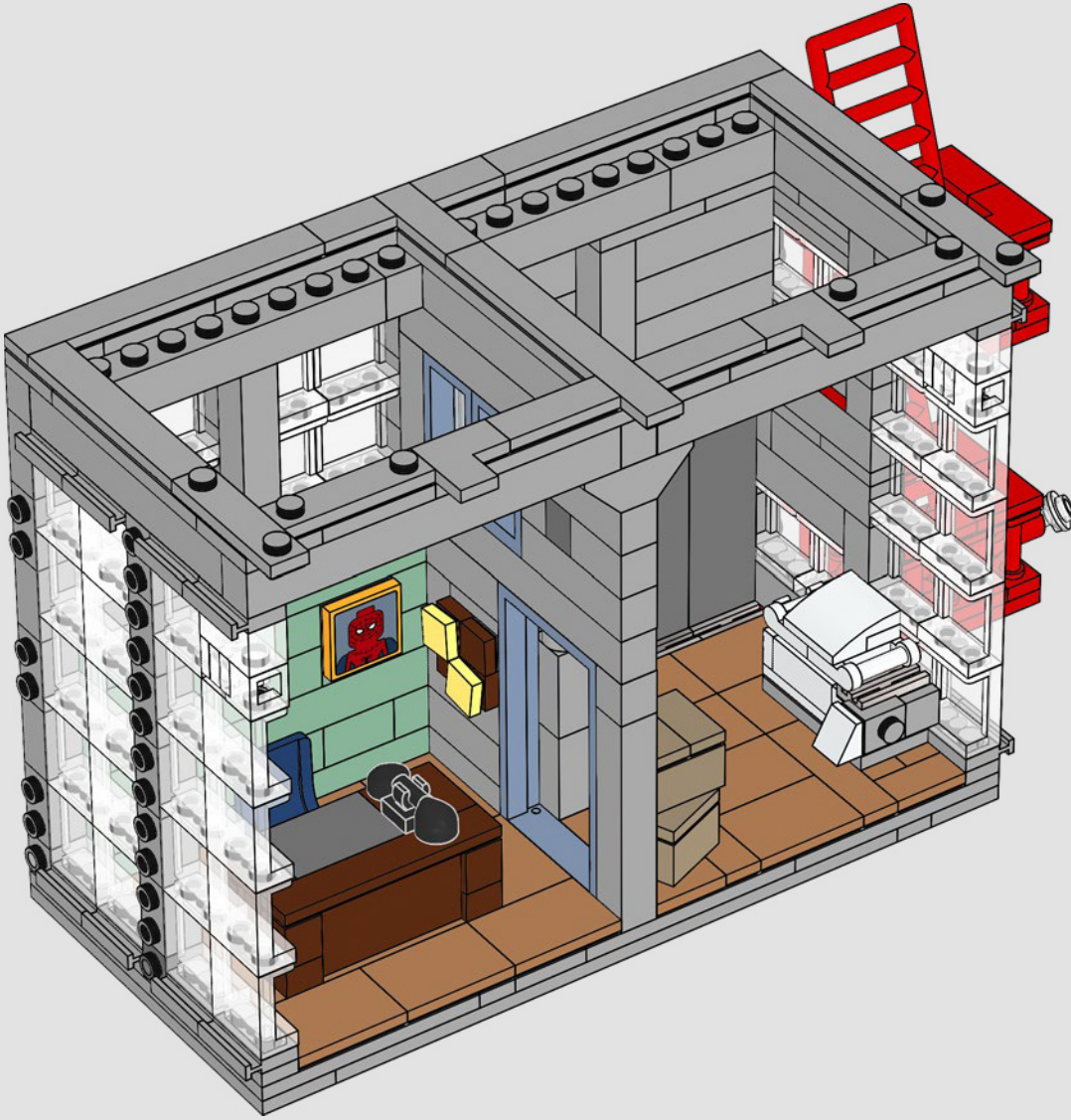

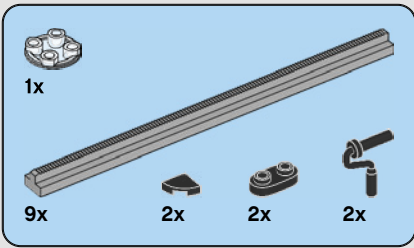

# 343

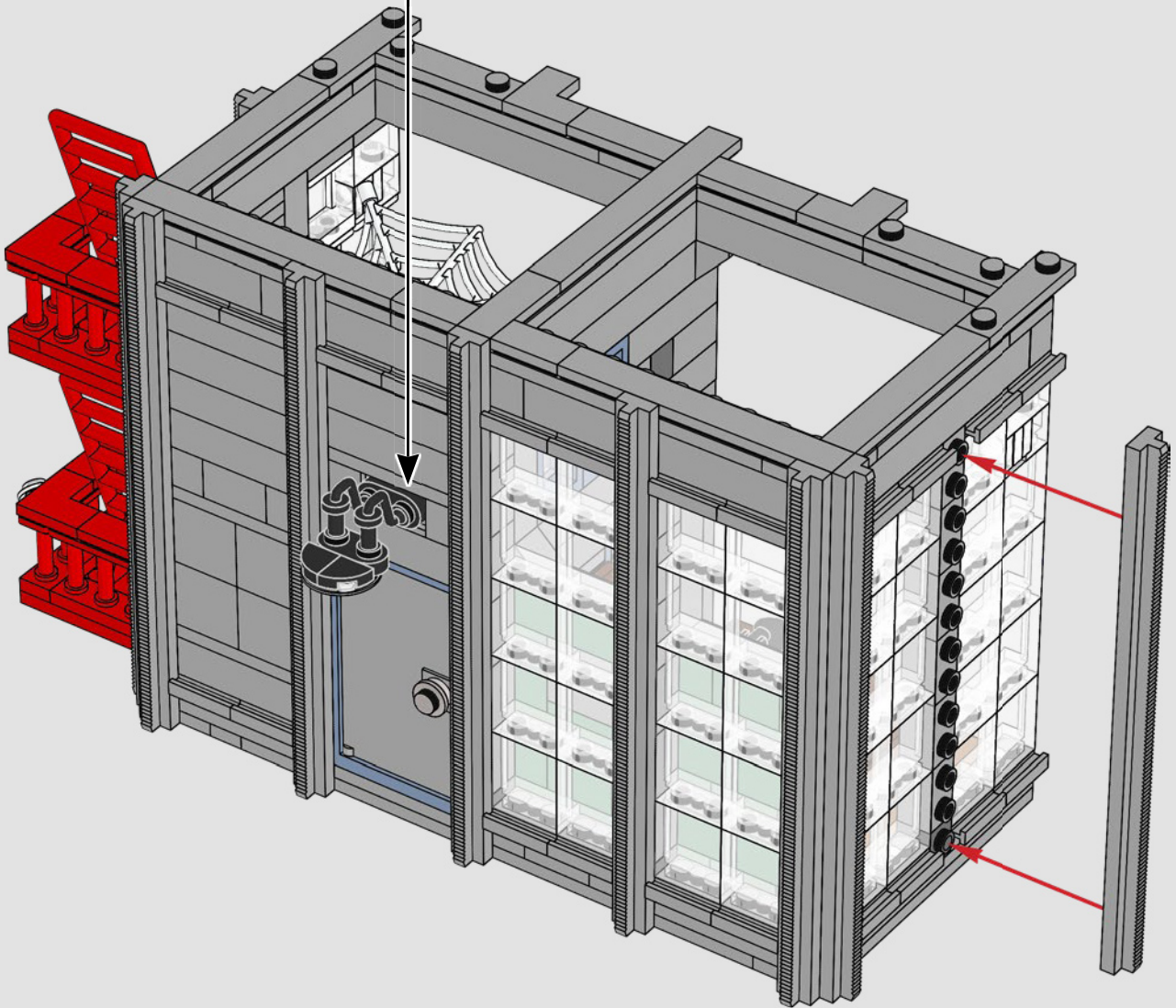
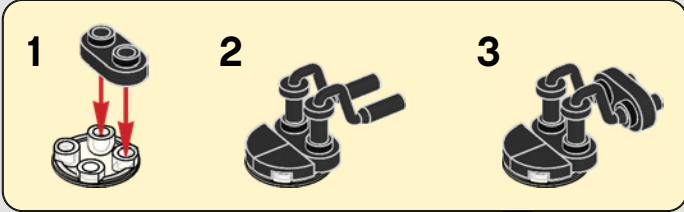





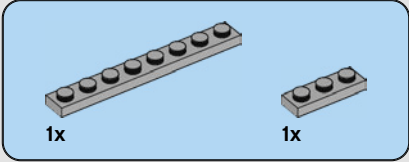
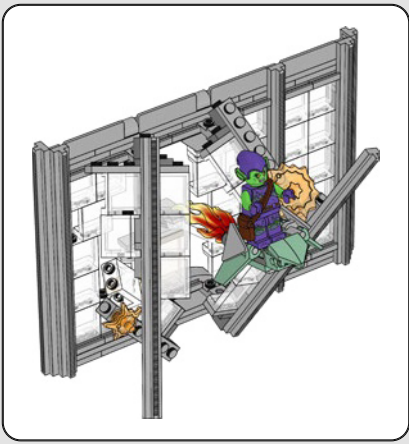

**345**

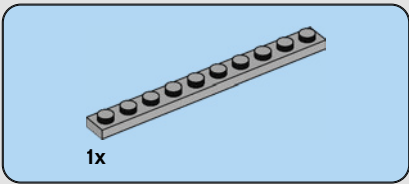
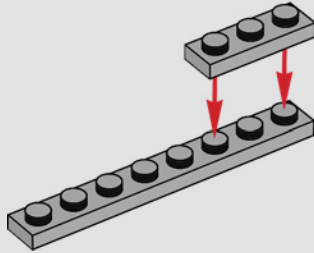

**346**

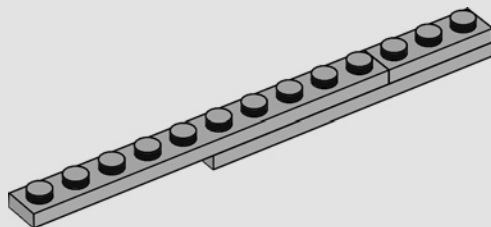

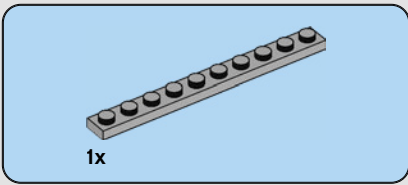

347

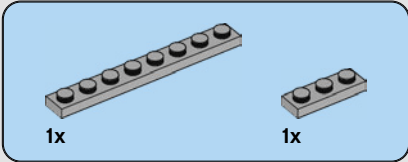
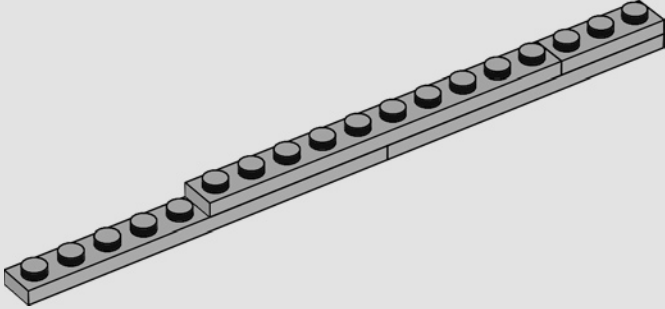

348

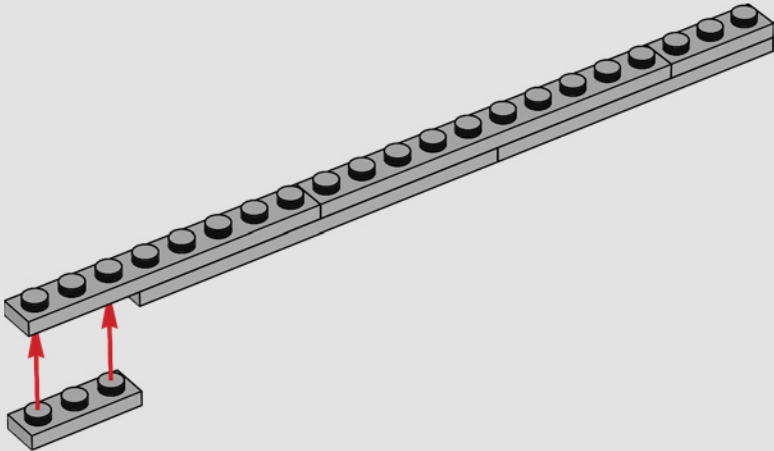



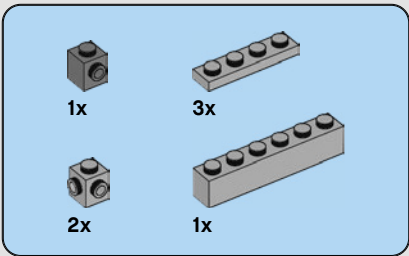

# 349

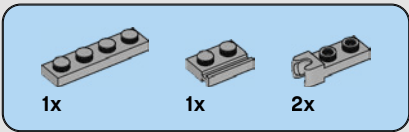
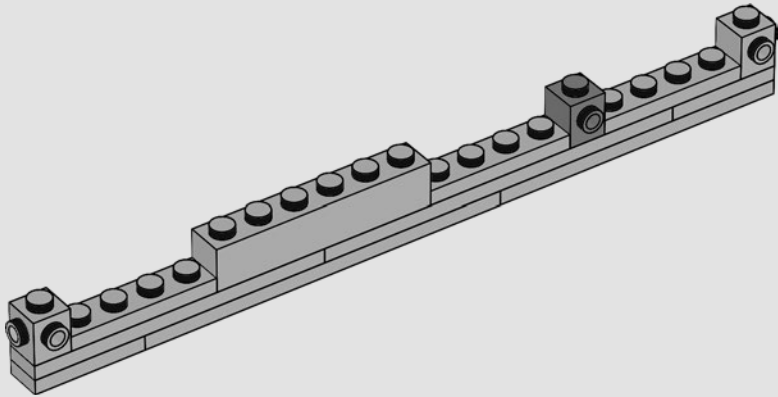

# 350

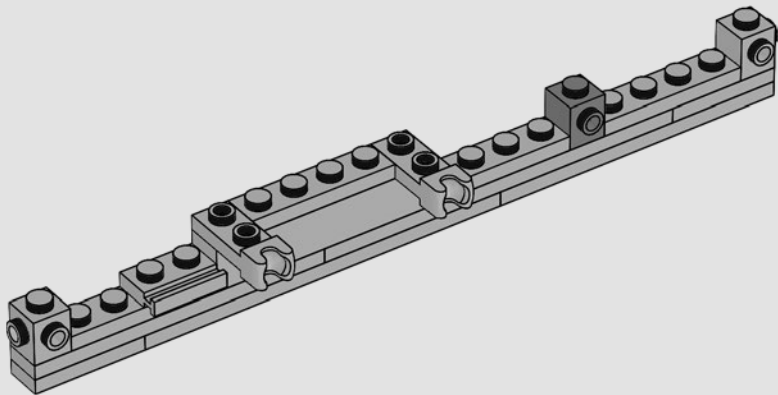

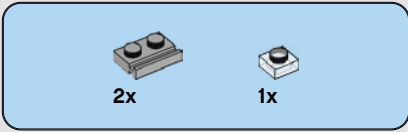

# 351

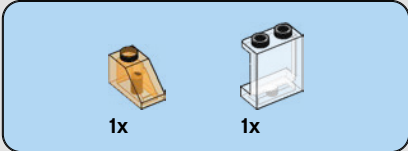
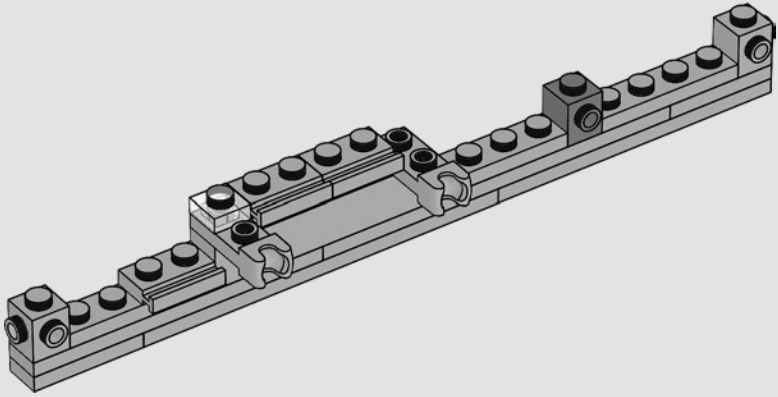

# 352

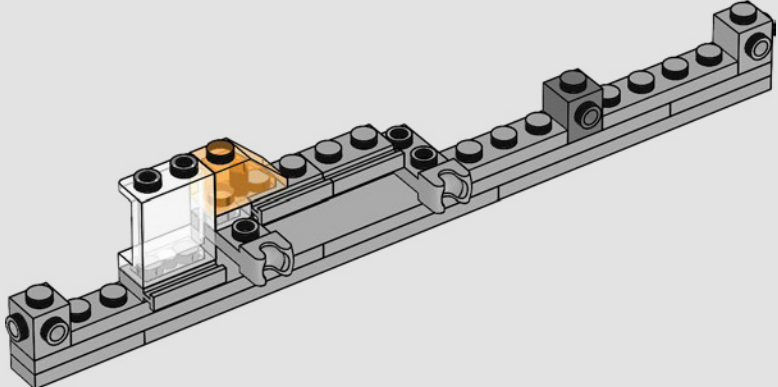



# 353

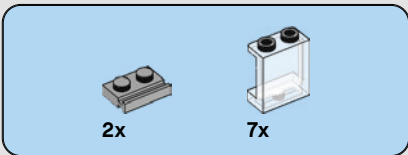
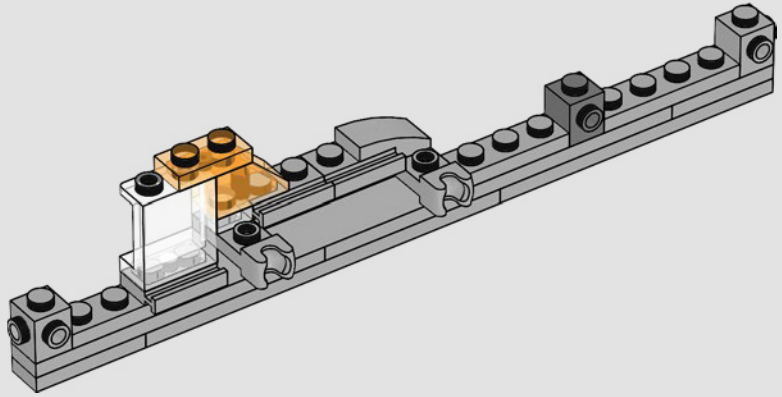

# 354

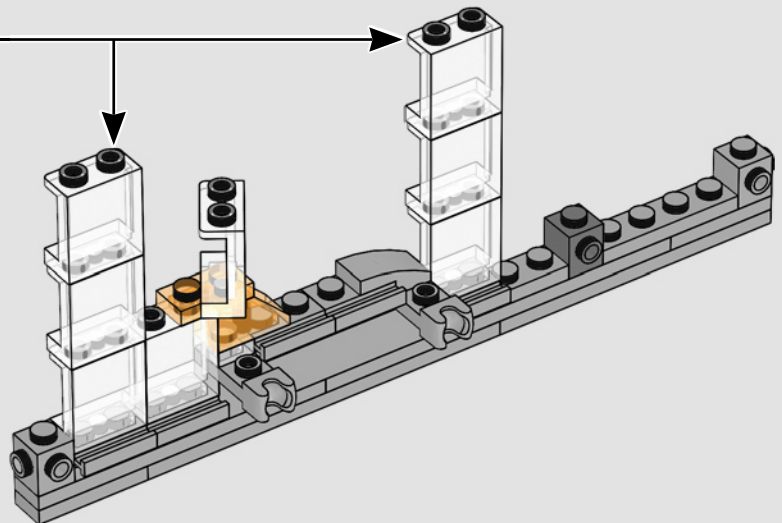
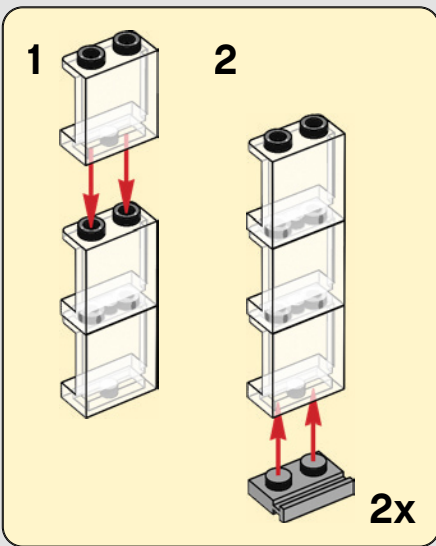



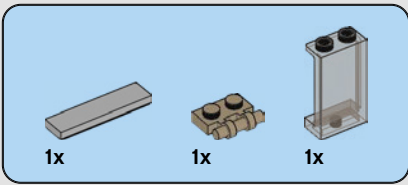

355

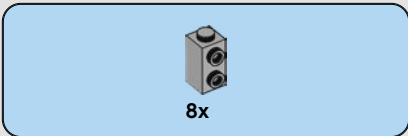
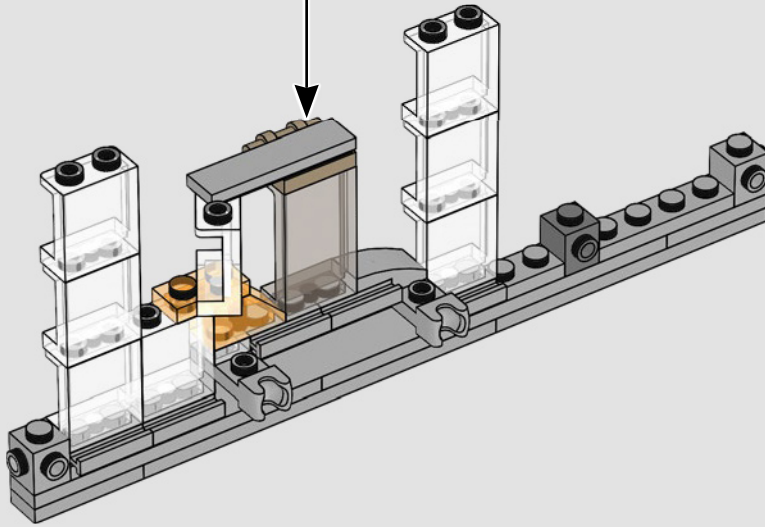
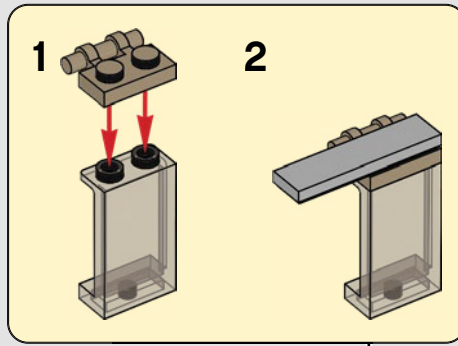

356

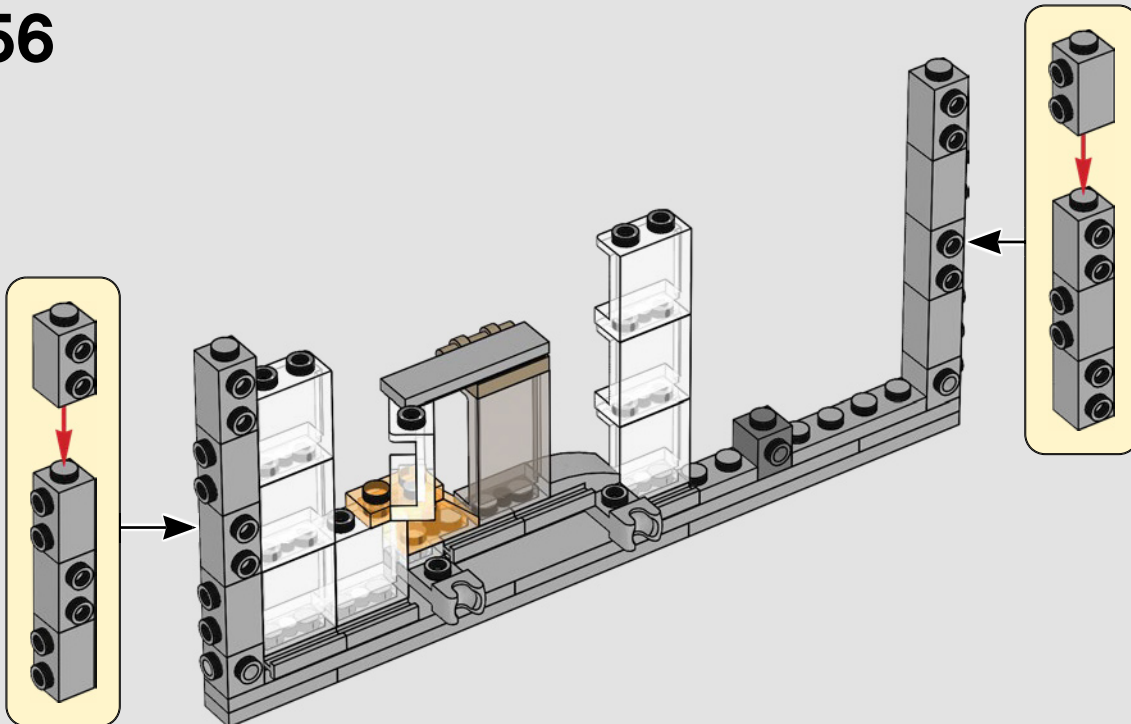

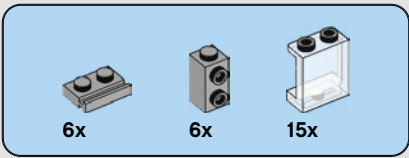

# 357

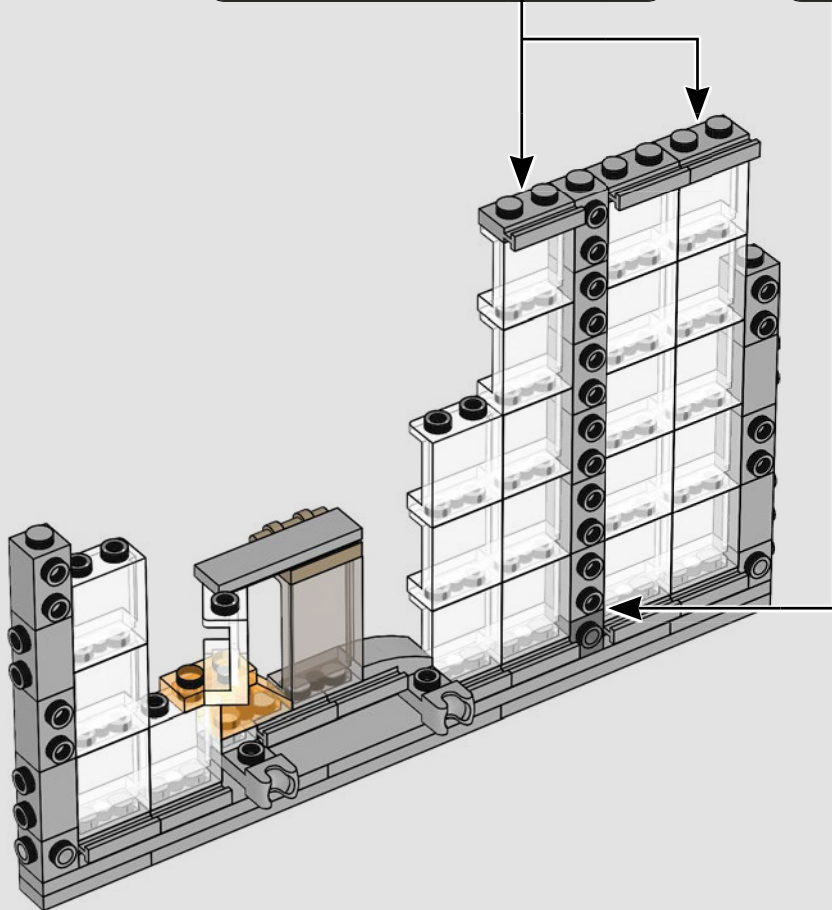
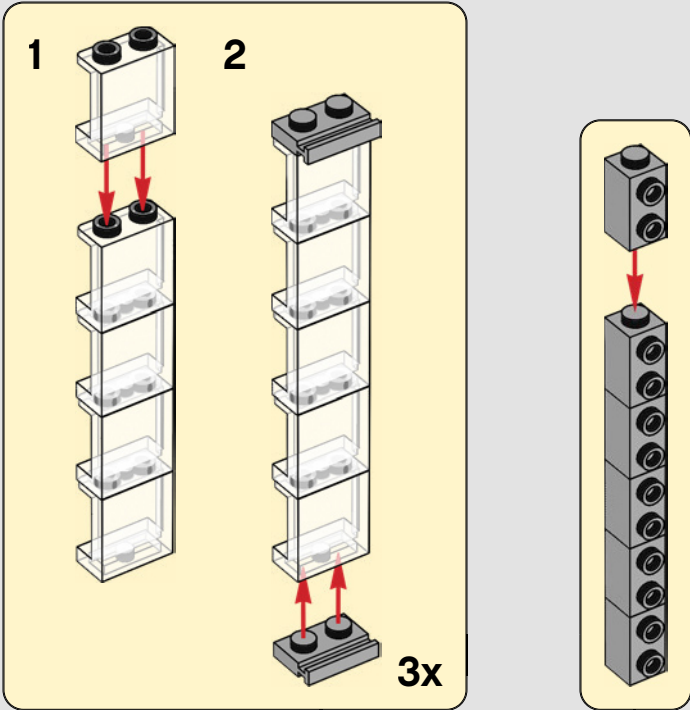

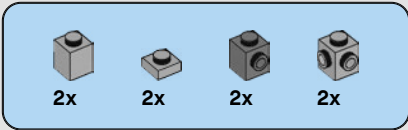

# 358

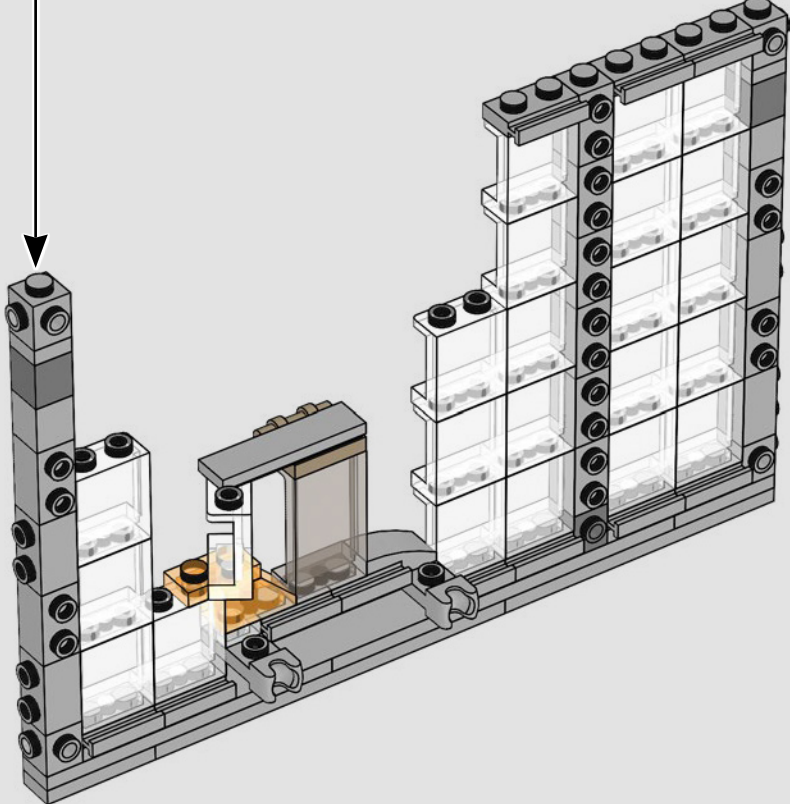
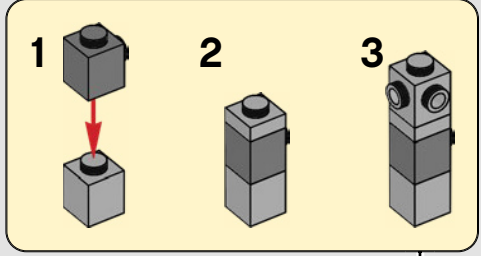
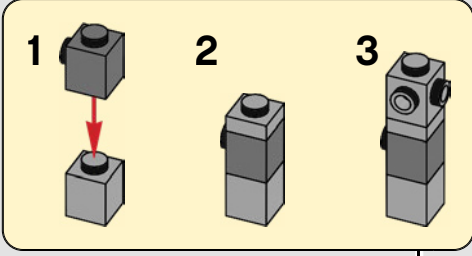



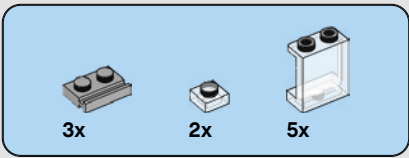

# 359

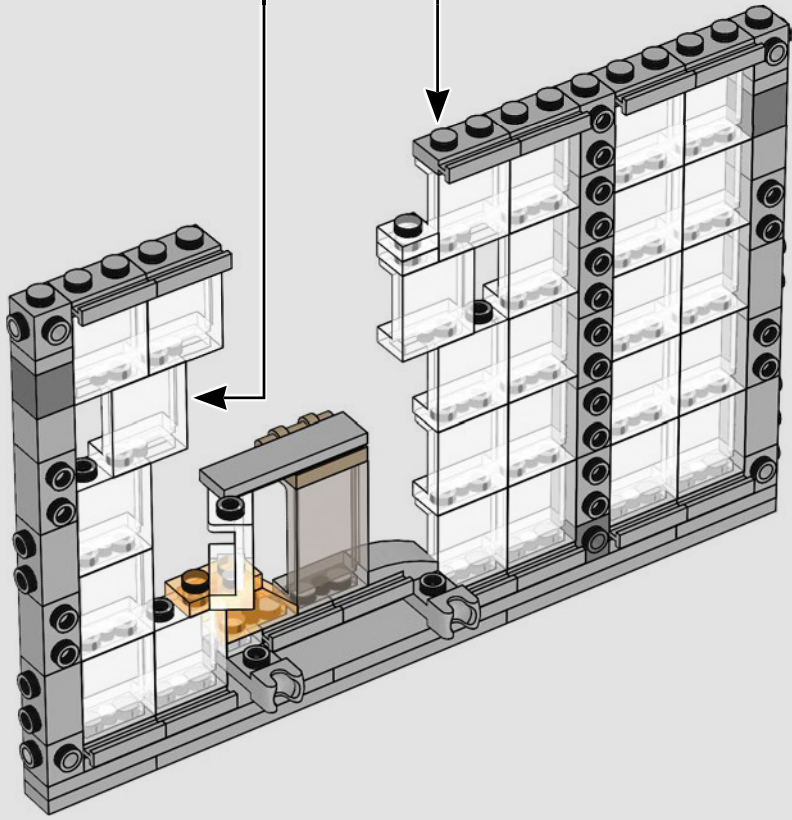
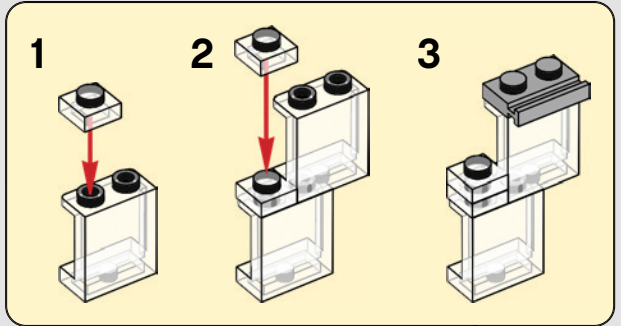
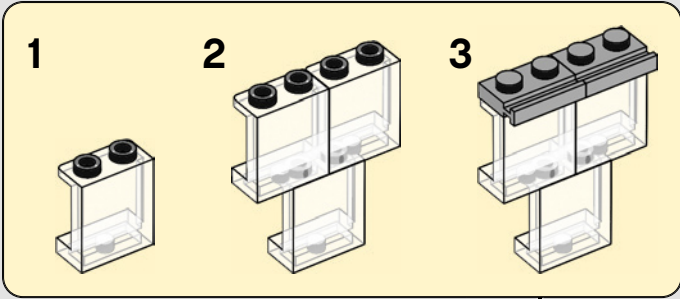

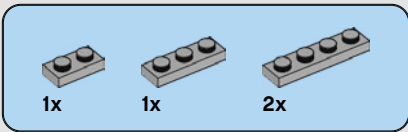

# 360

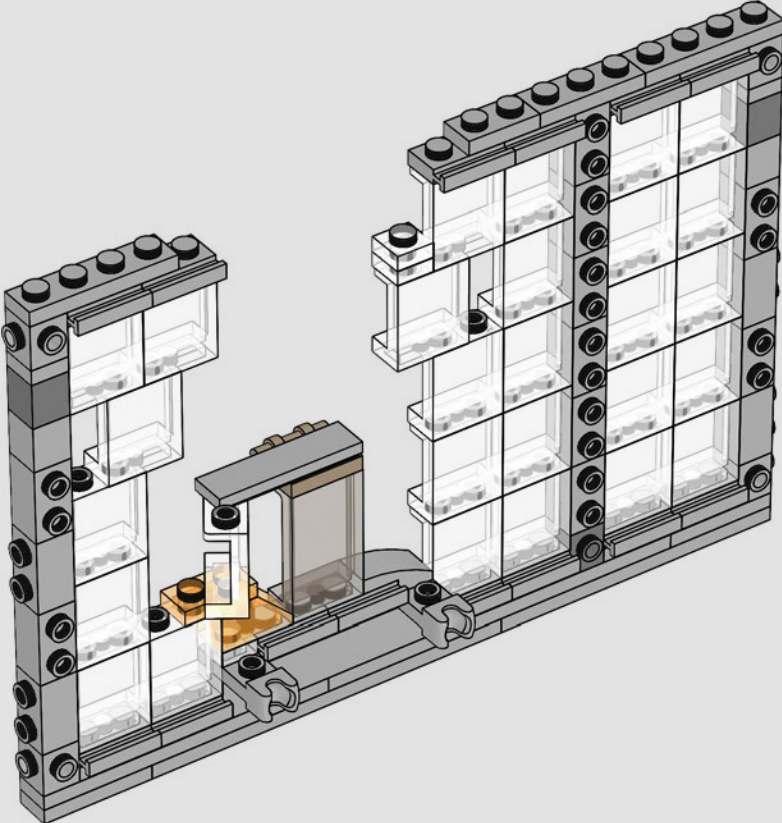

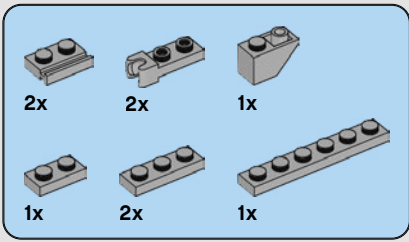

# 361

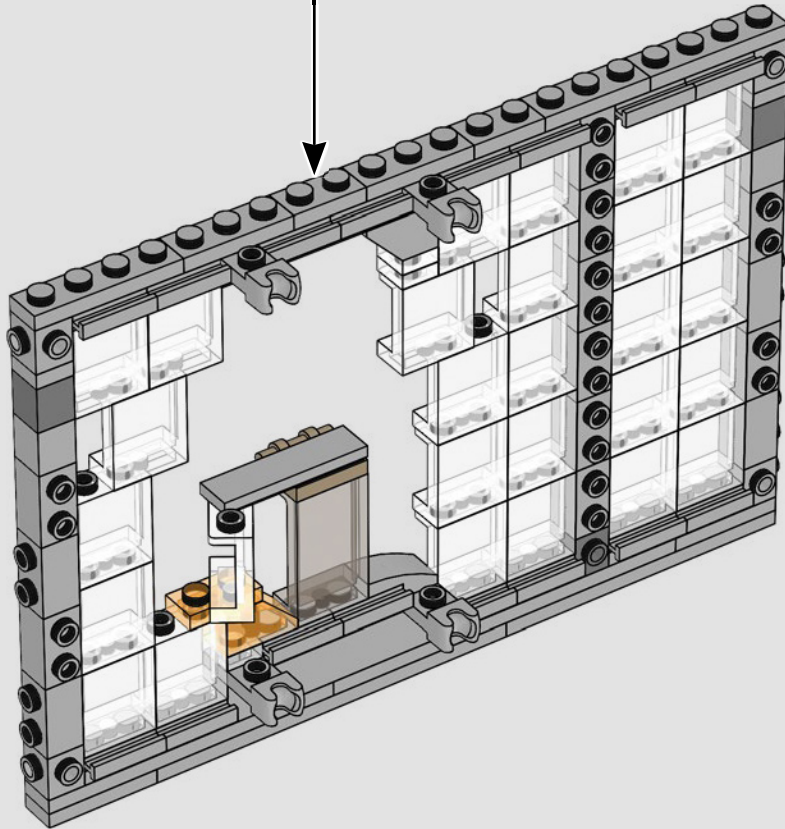
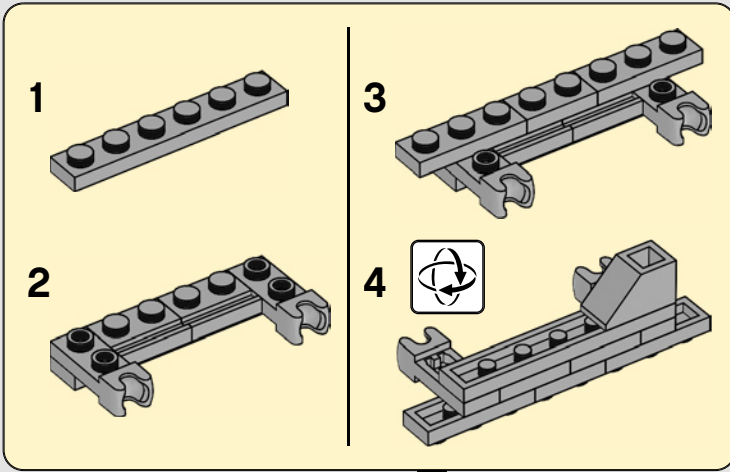



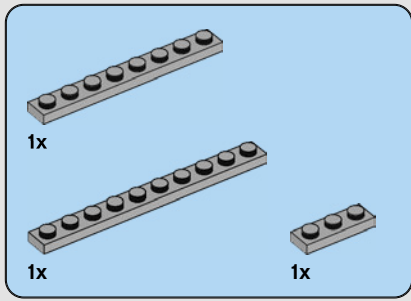

362

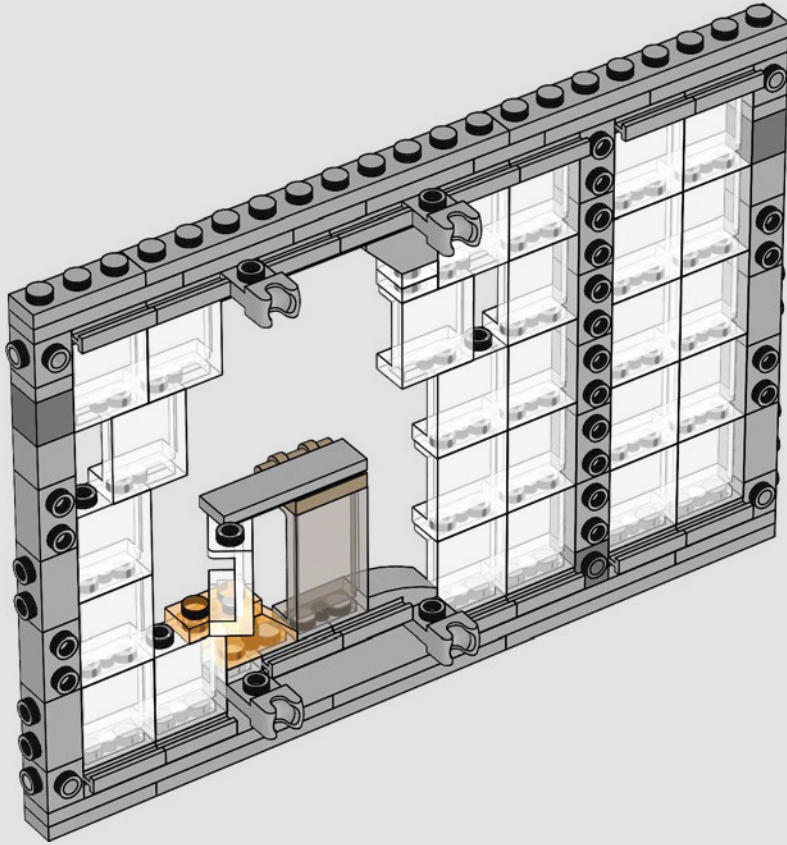

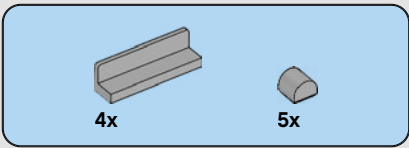

**363**

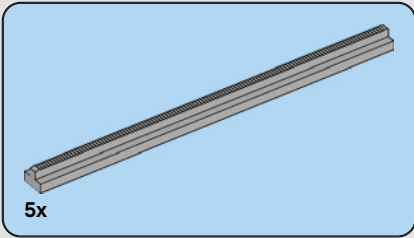
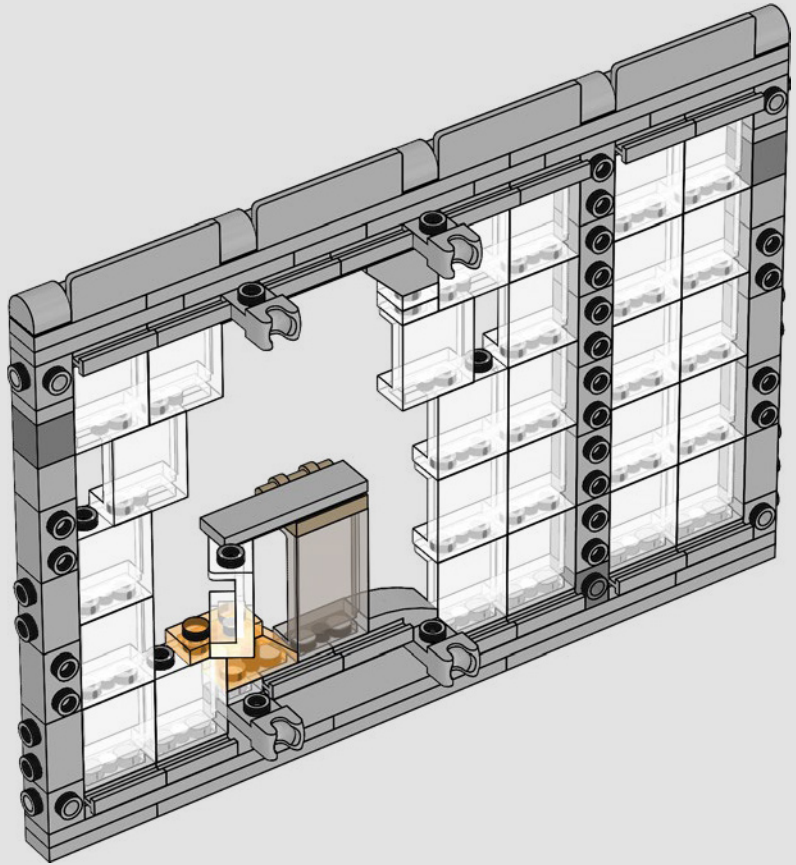

**364**

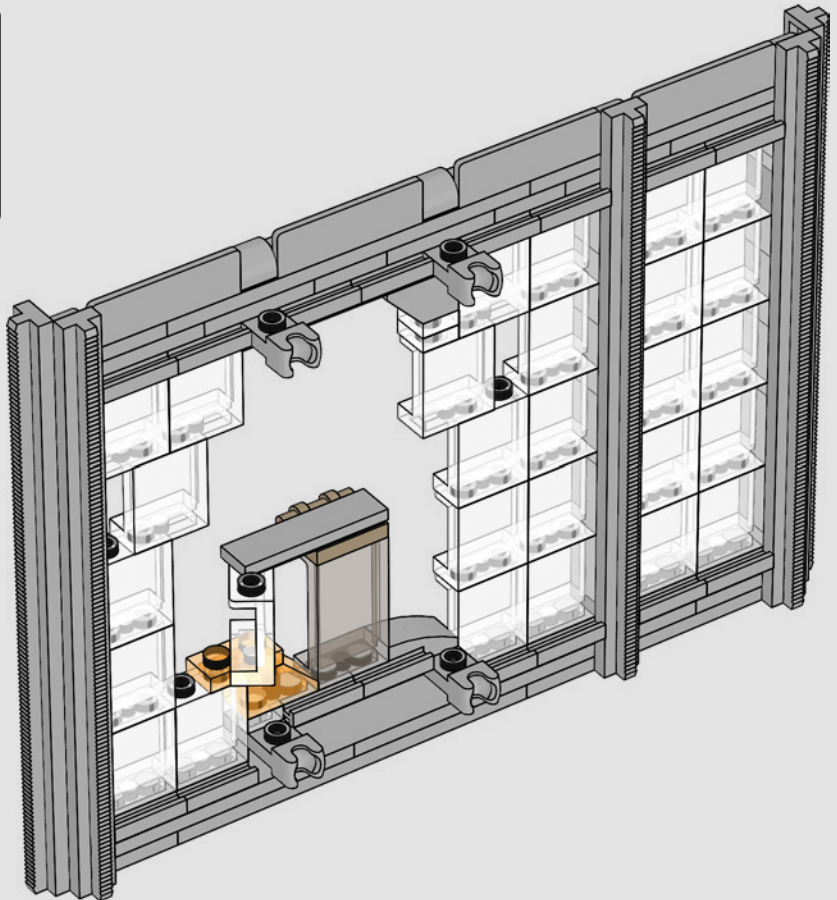

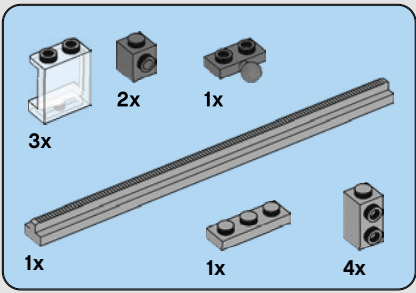

365

1

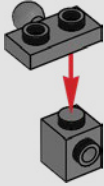

2

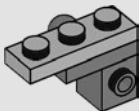

3

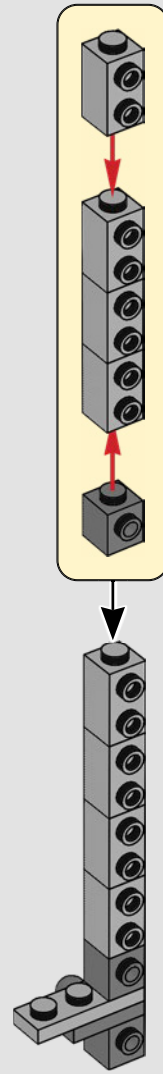

4

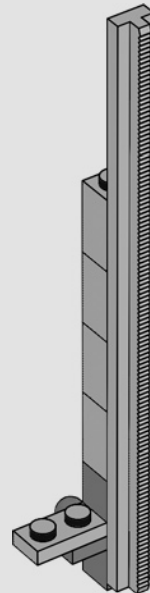



5

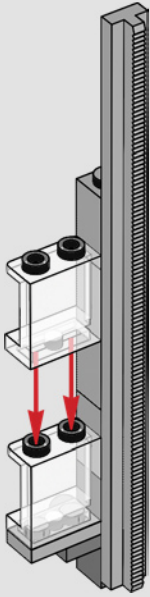

6

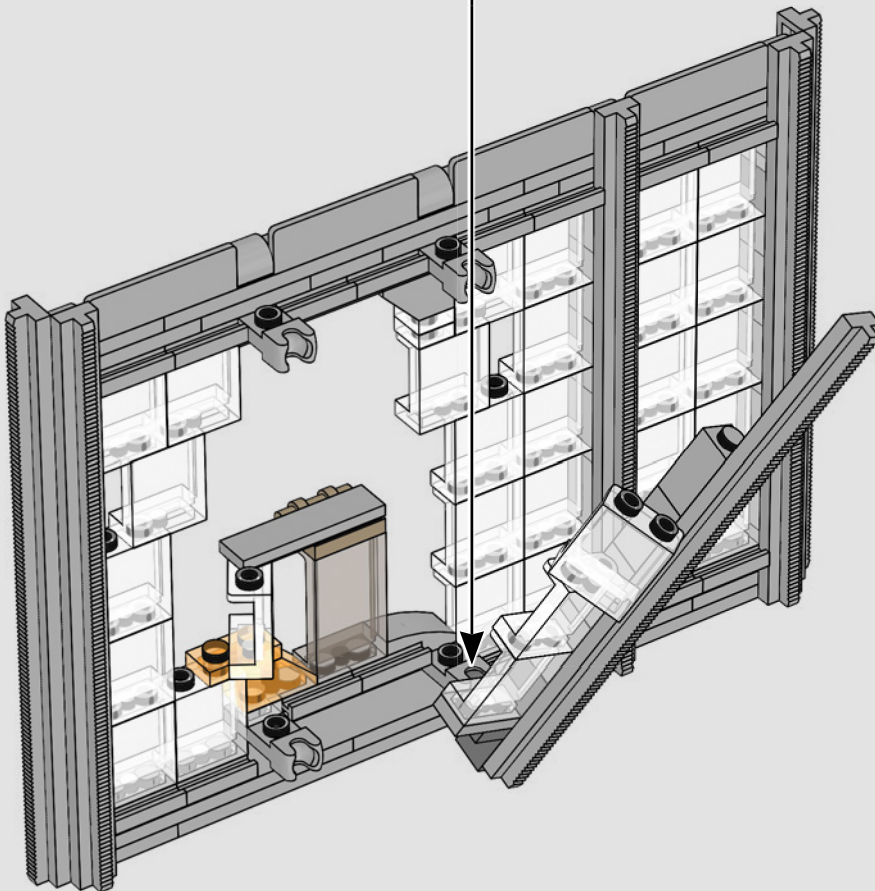
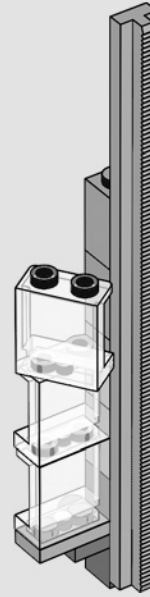



5

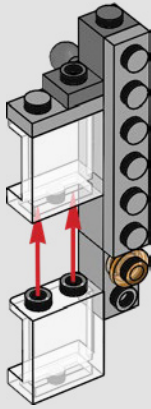

6

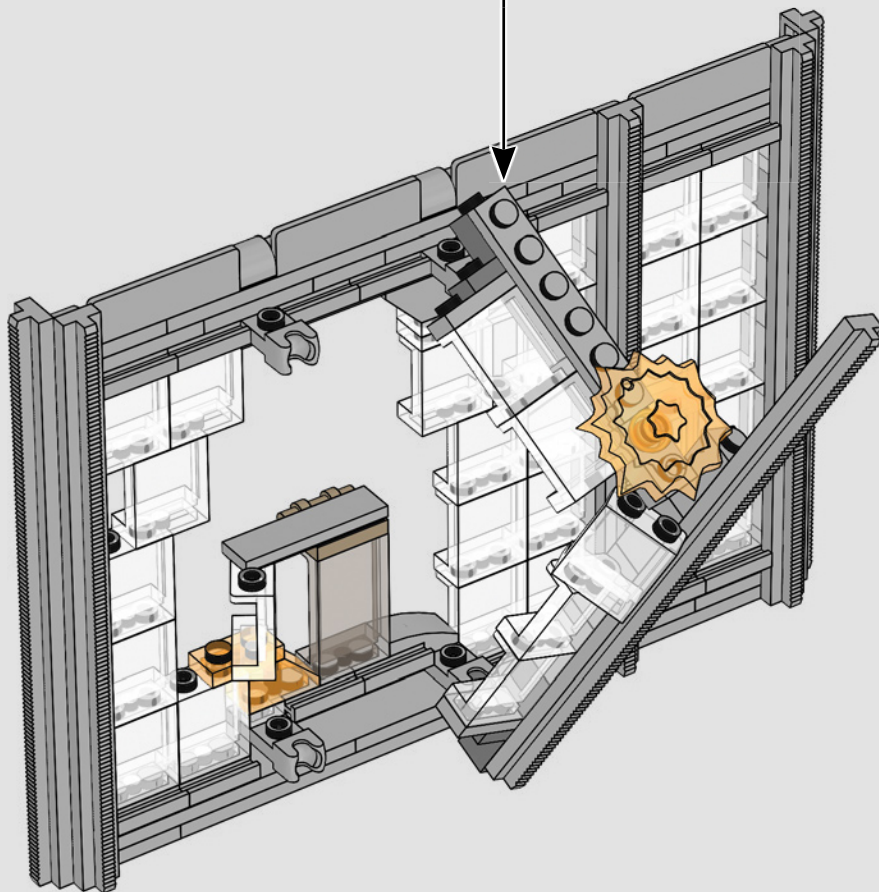
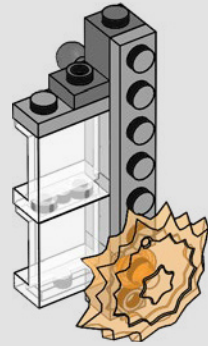



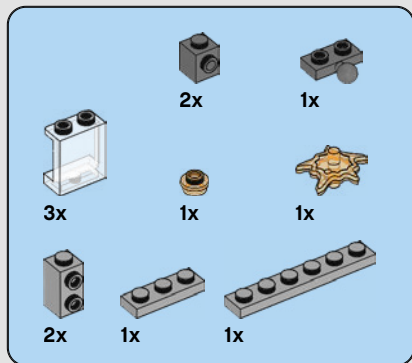

**367**

**1**

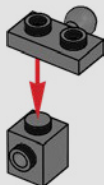

**2**

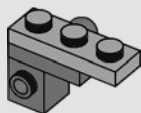

**3**

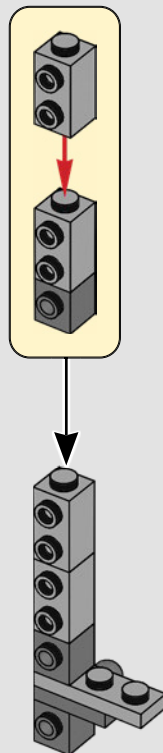

**4**

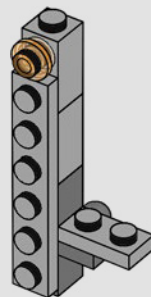

5

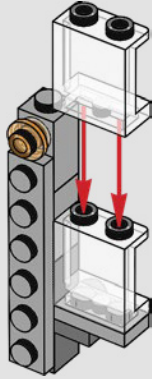

6

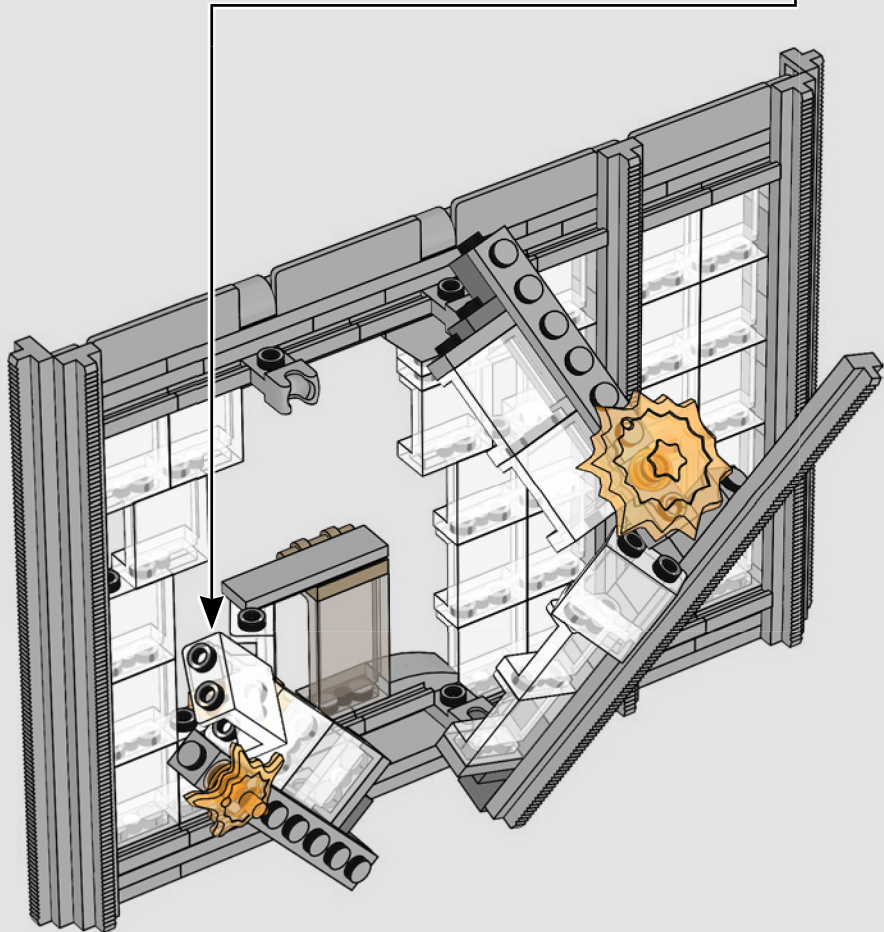
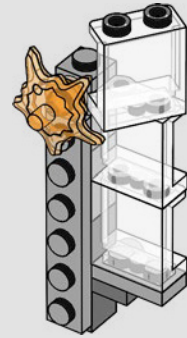

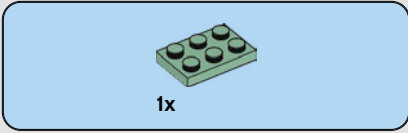
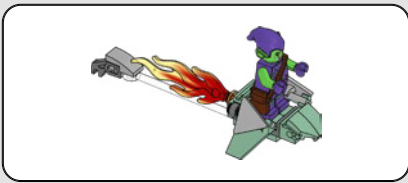

**368**

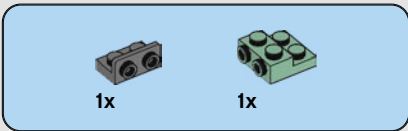
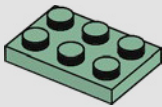

**369**

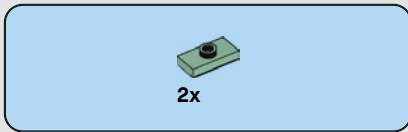
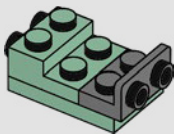

**370**

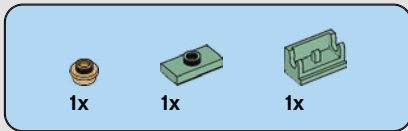
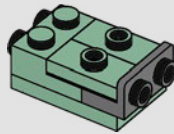

**371**

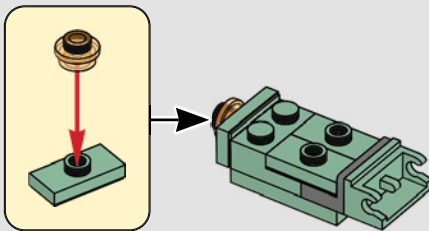



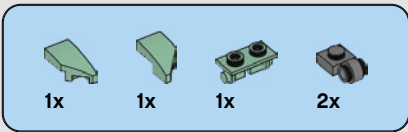

**372**

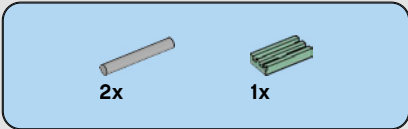
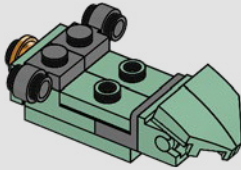
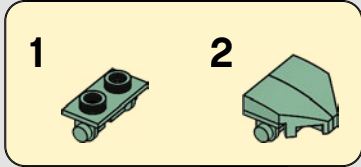

**373**

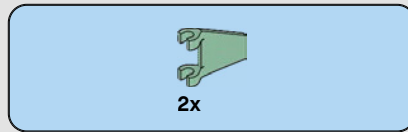
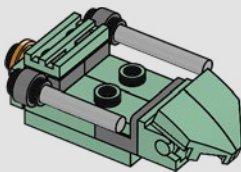

**374**

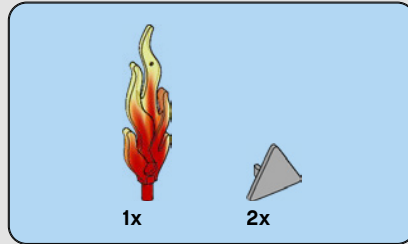
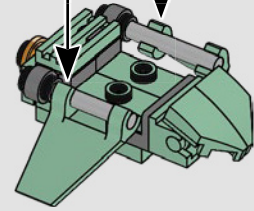
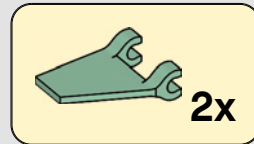

**375**

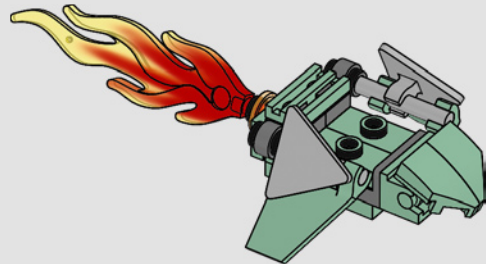

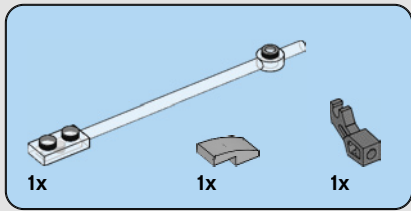

376

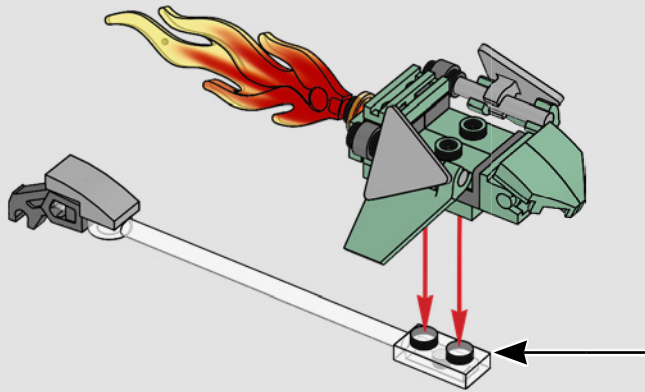
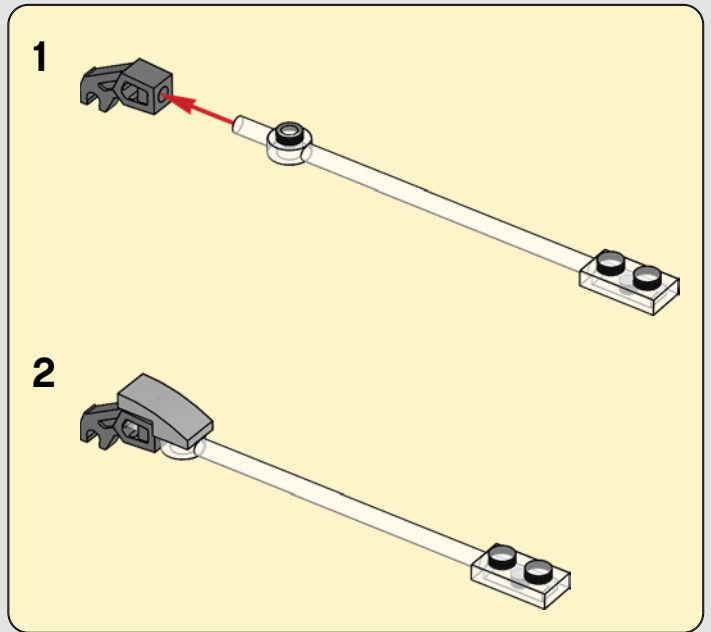

377

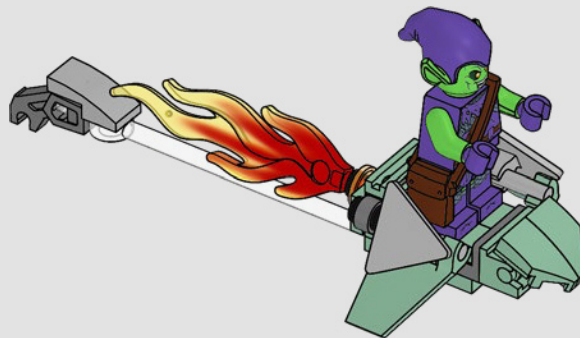

378

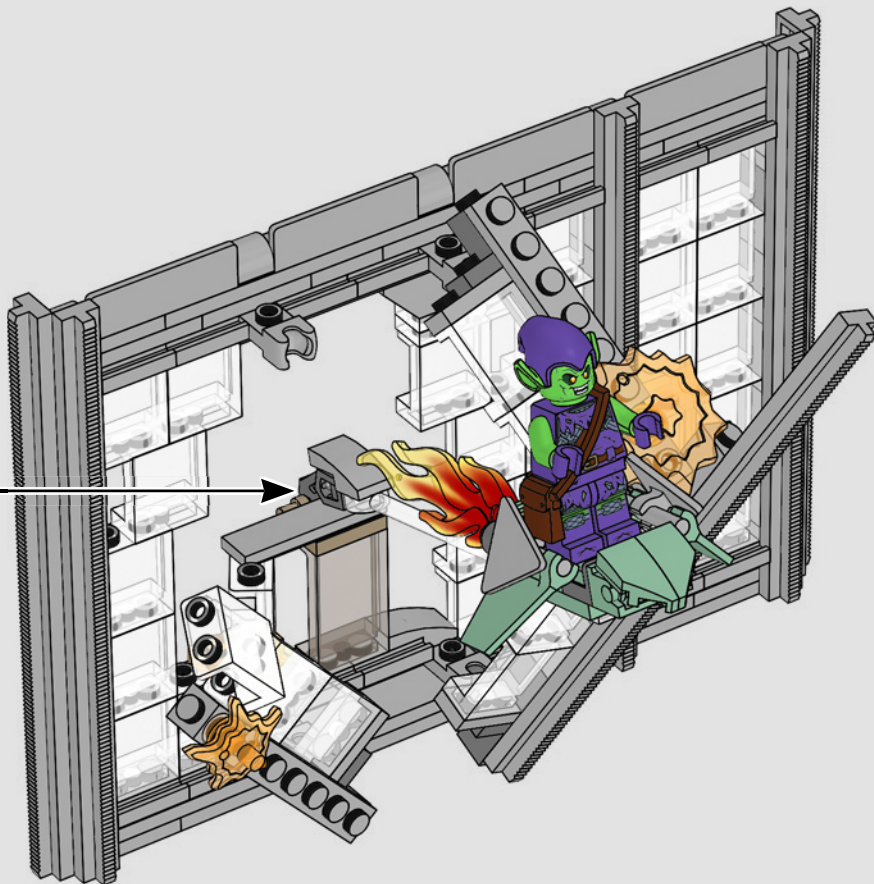



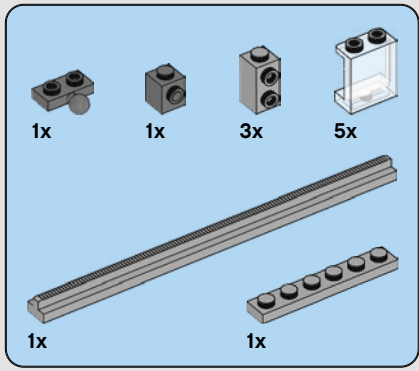

**379**

**1**

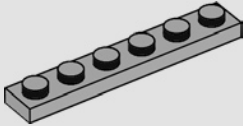

**2**

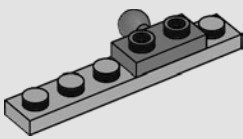

**3**

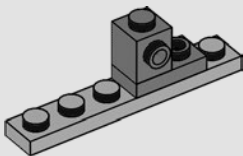

**4**

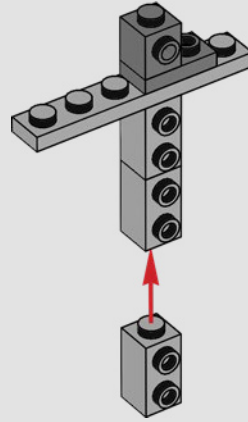

**5**

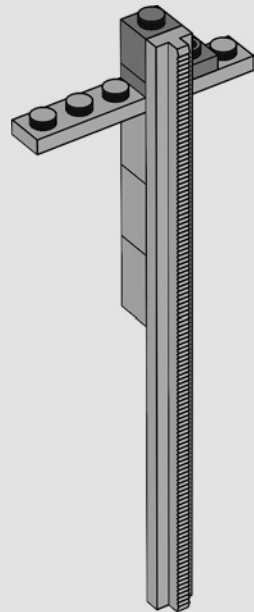

6

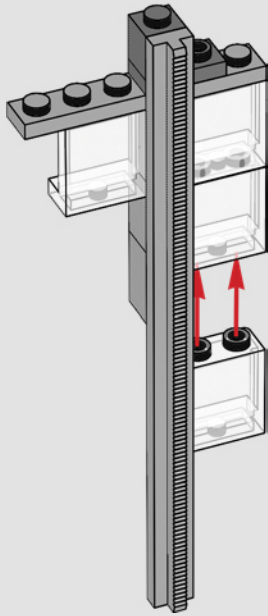

7

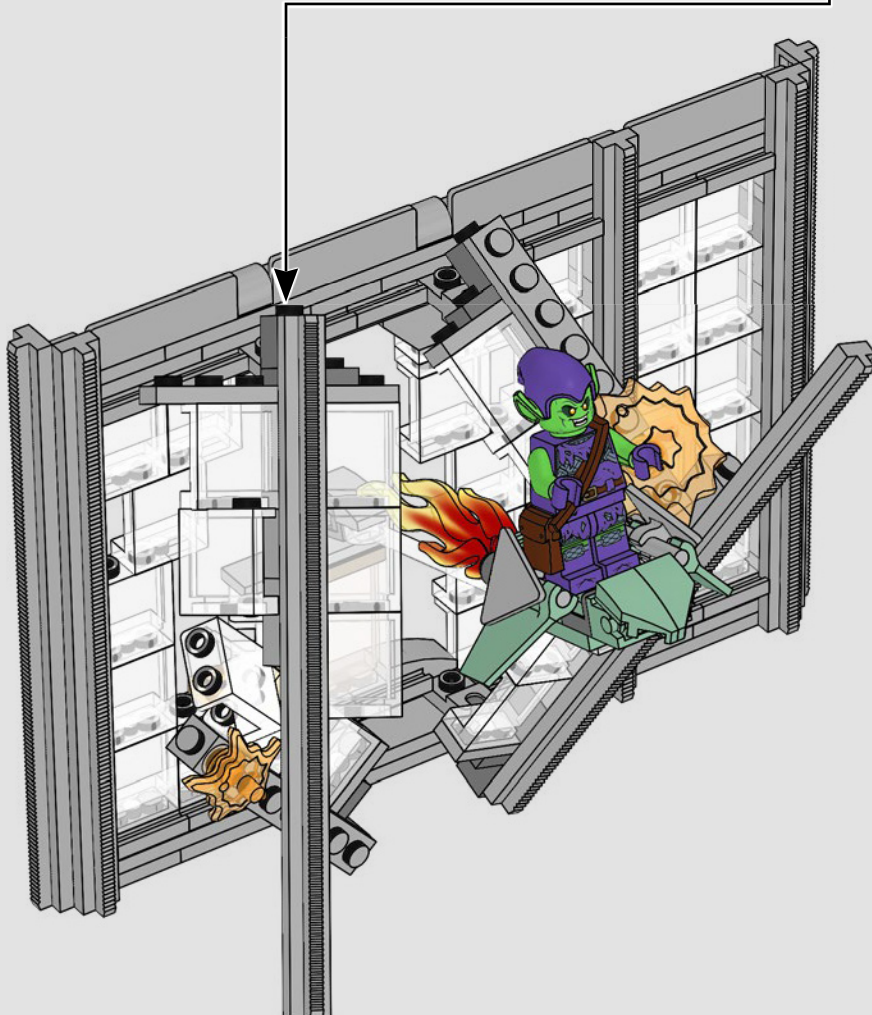
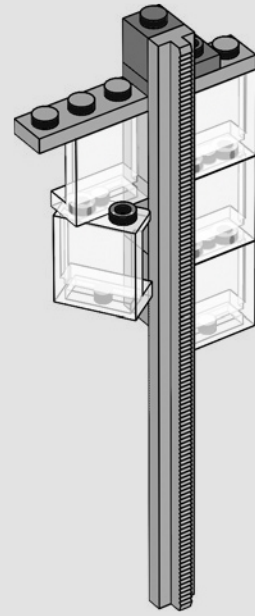







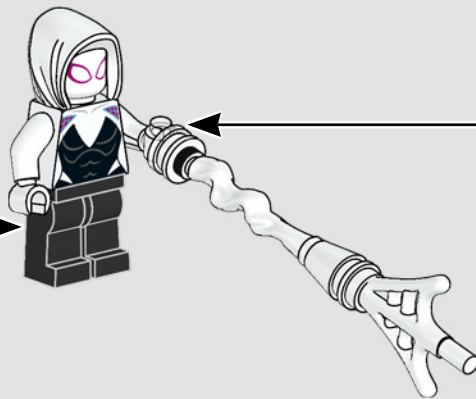
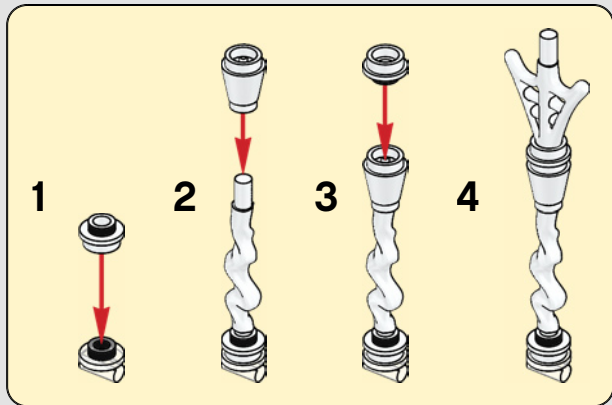
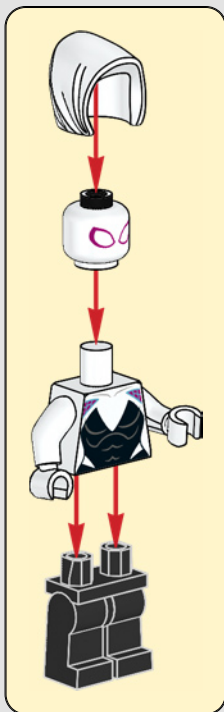
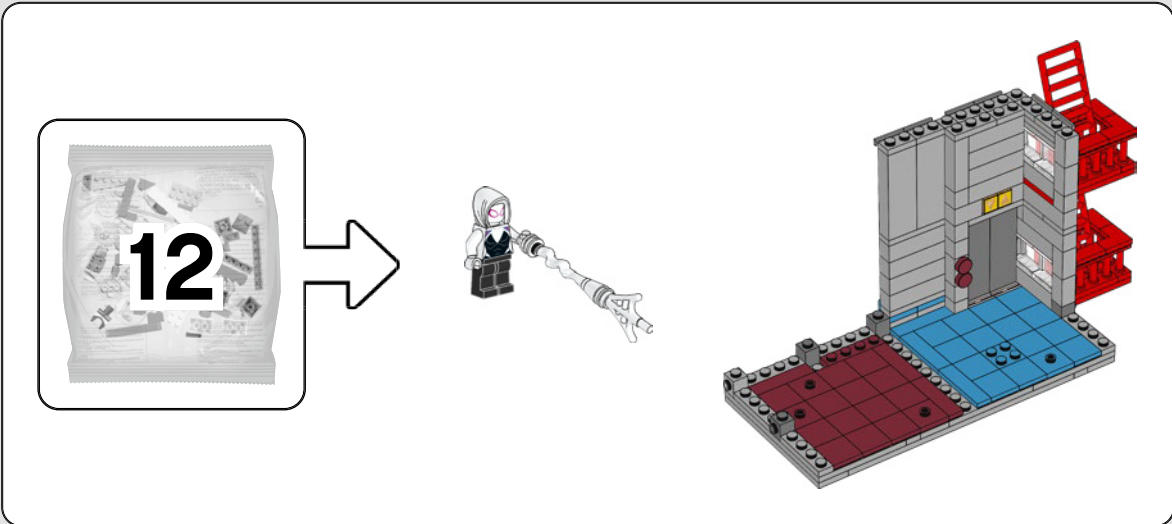

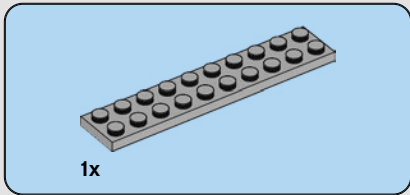
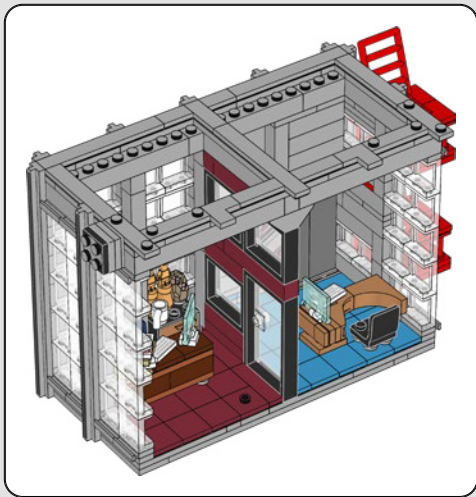

1x

**381**

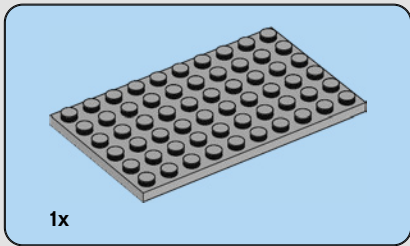
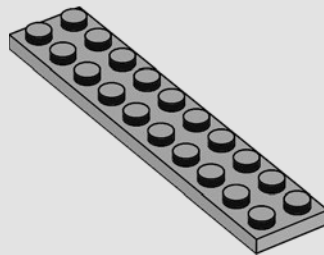

1x

**382**

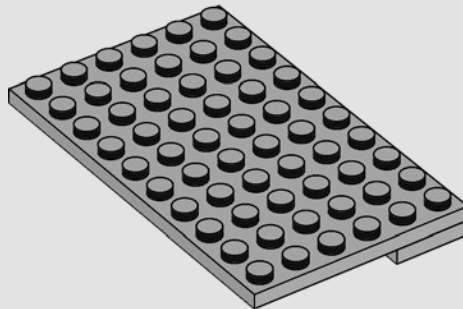

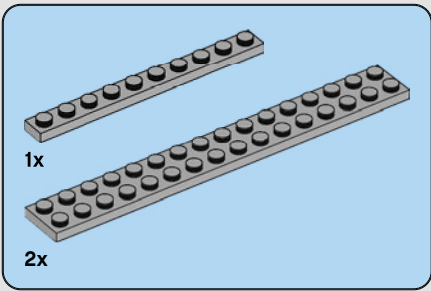

**383**

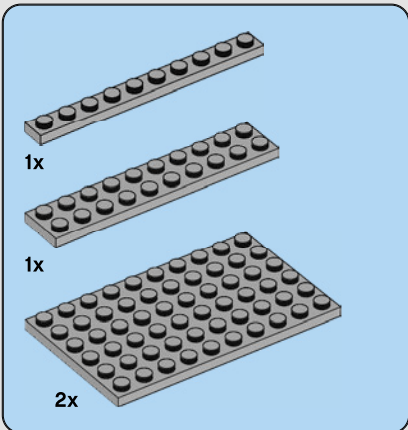
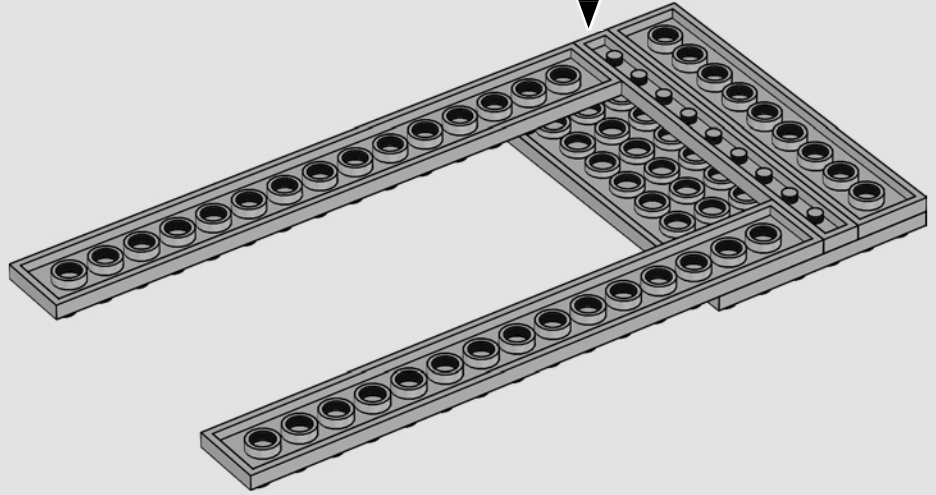
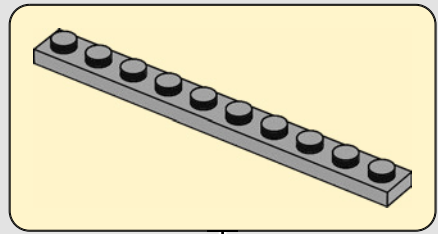

**384**

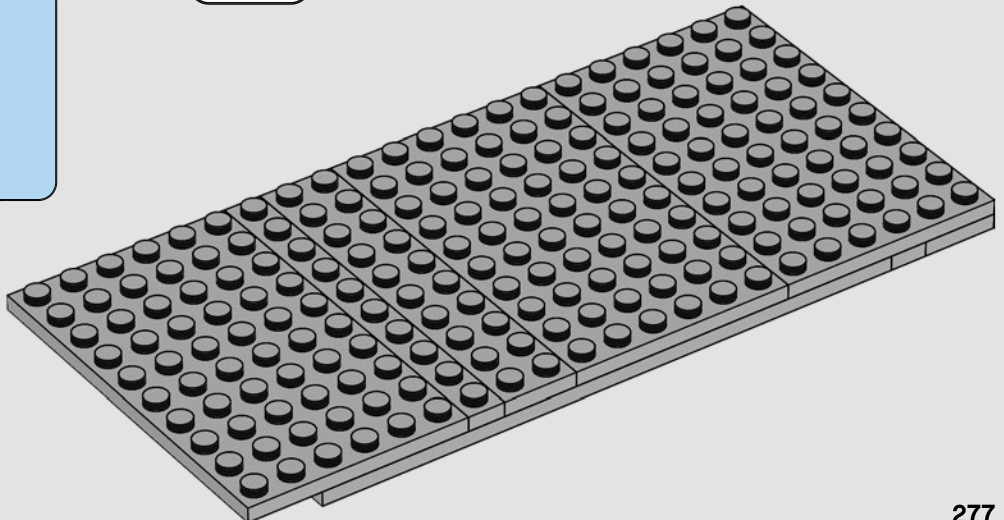
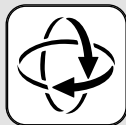



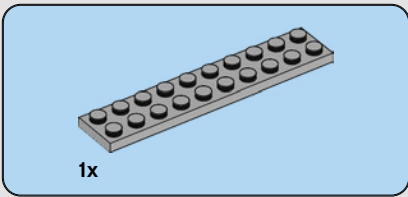

# 385

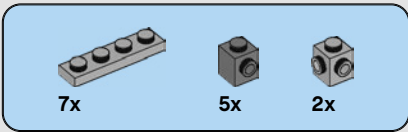
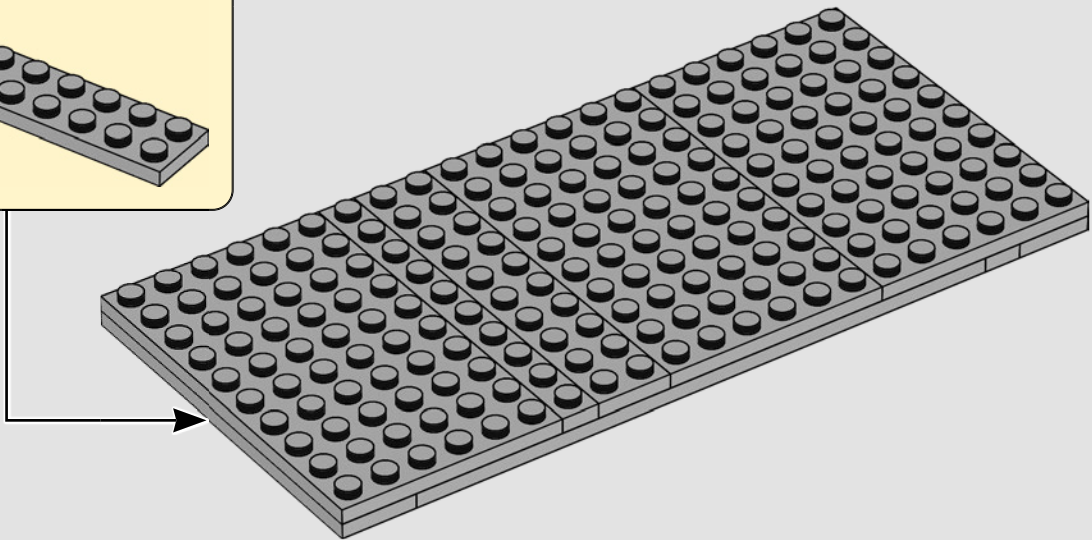
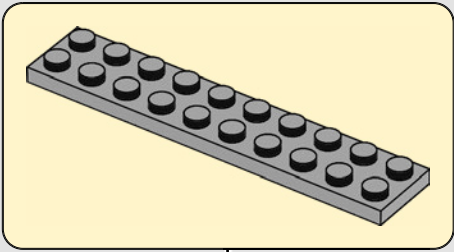

# 386

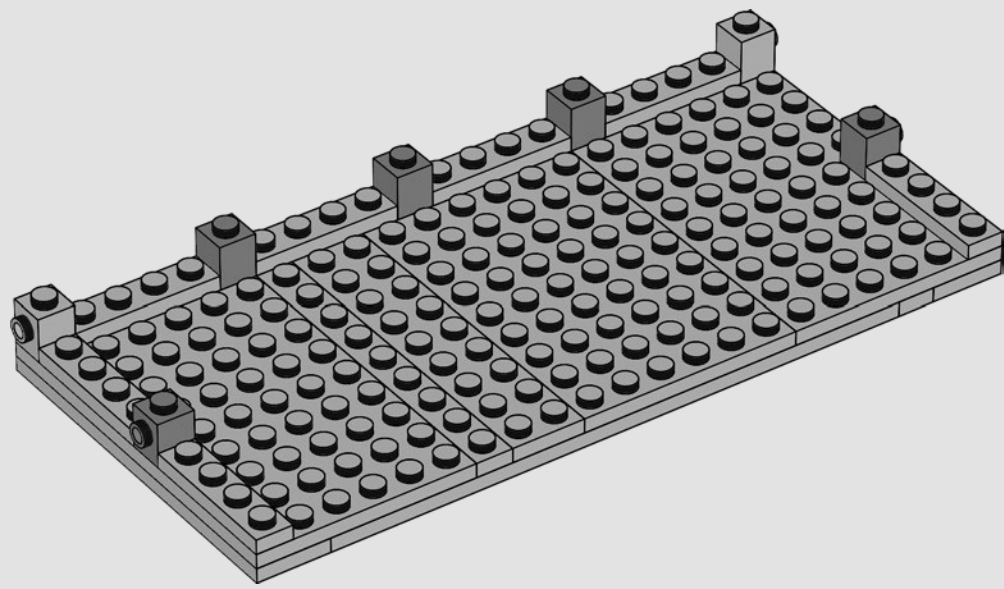

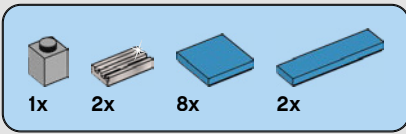

**387**

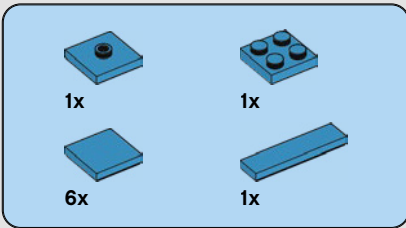
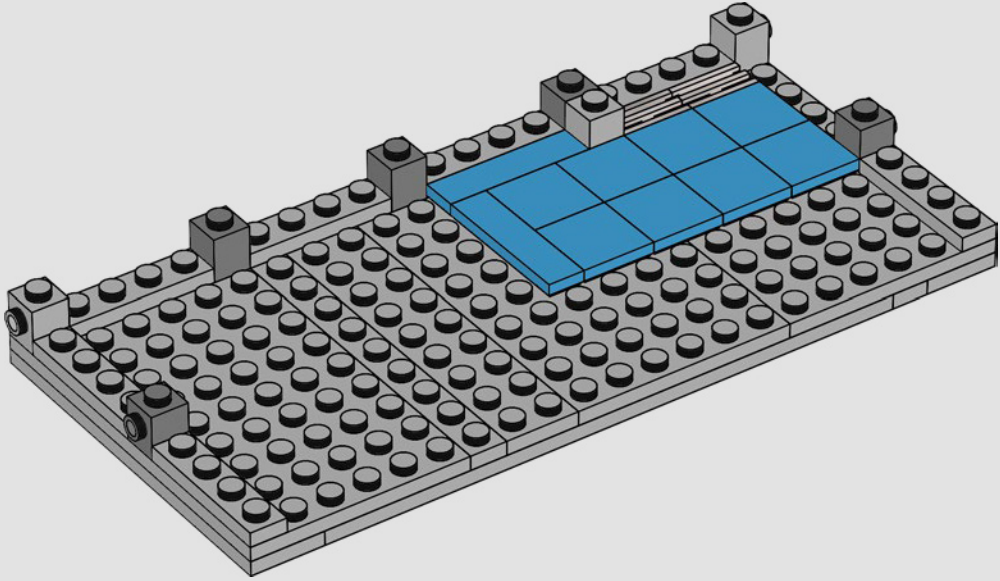

**388**

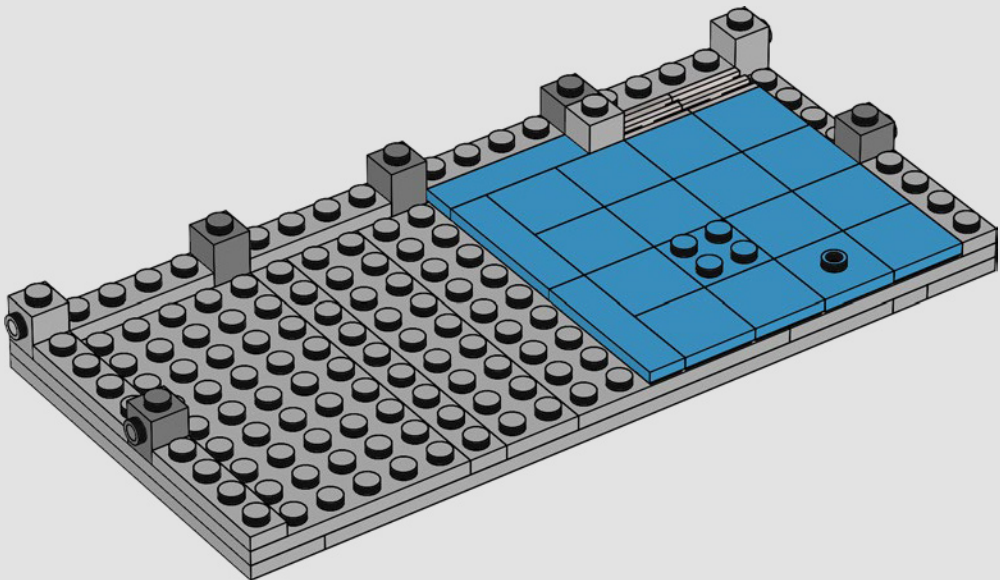

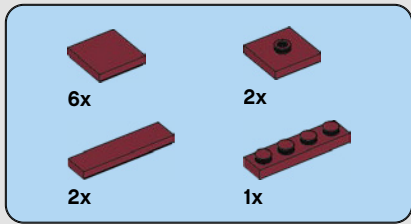

389

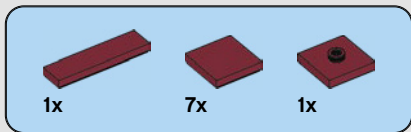
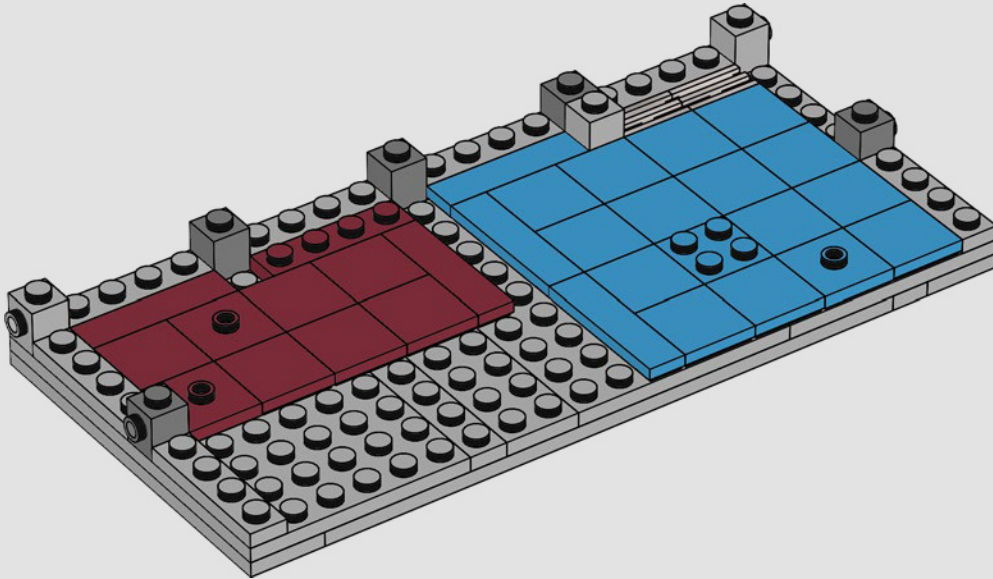

390

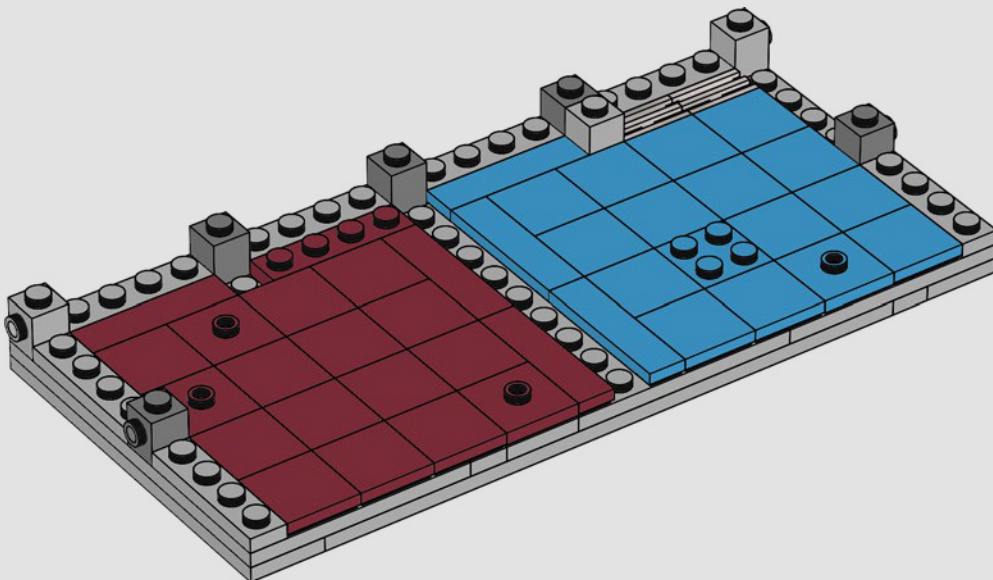





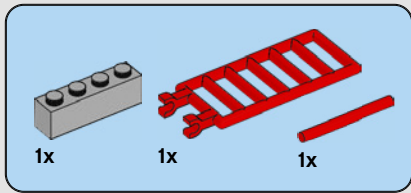

395

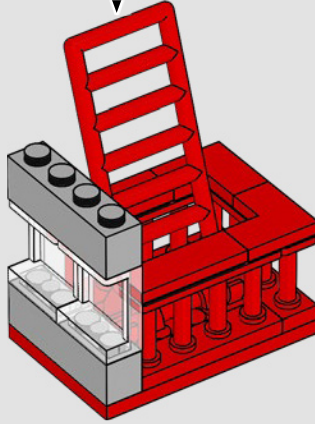
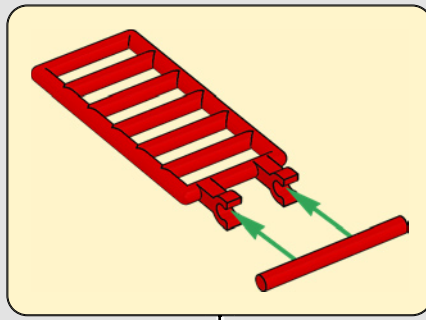

396

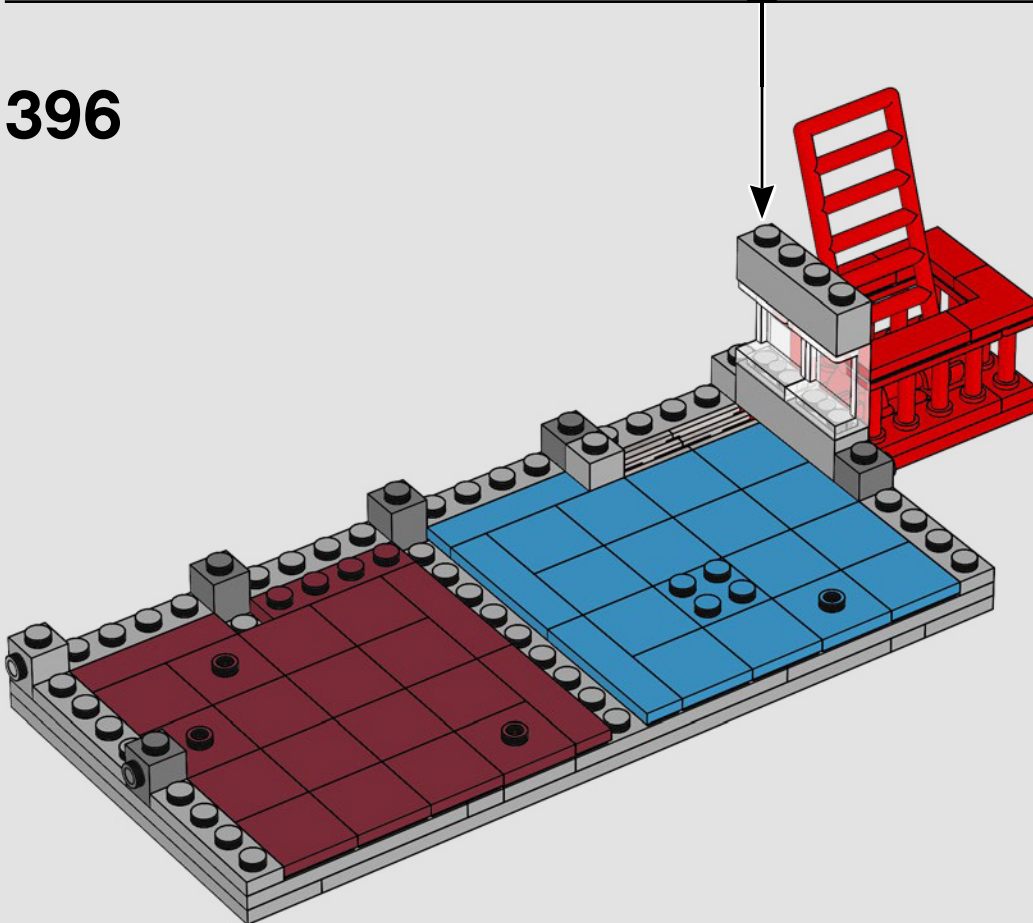



397

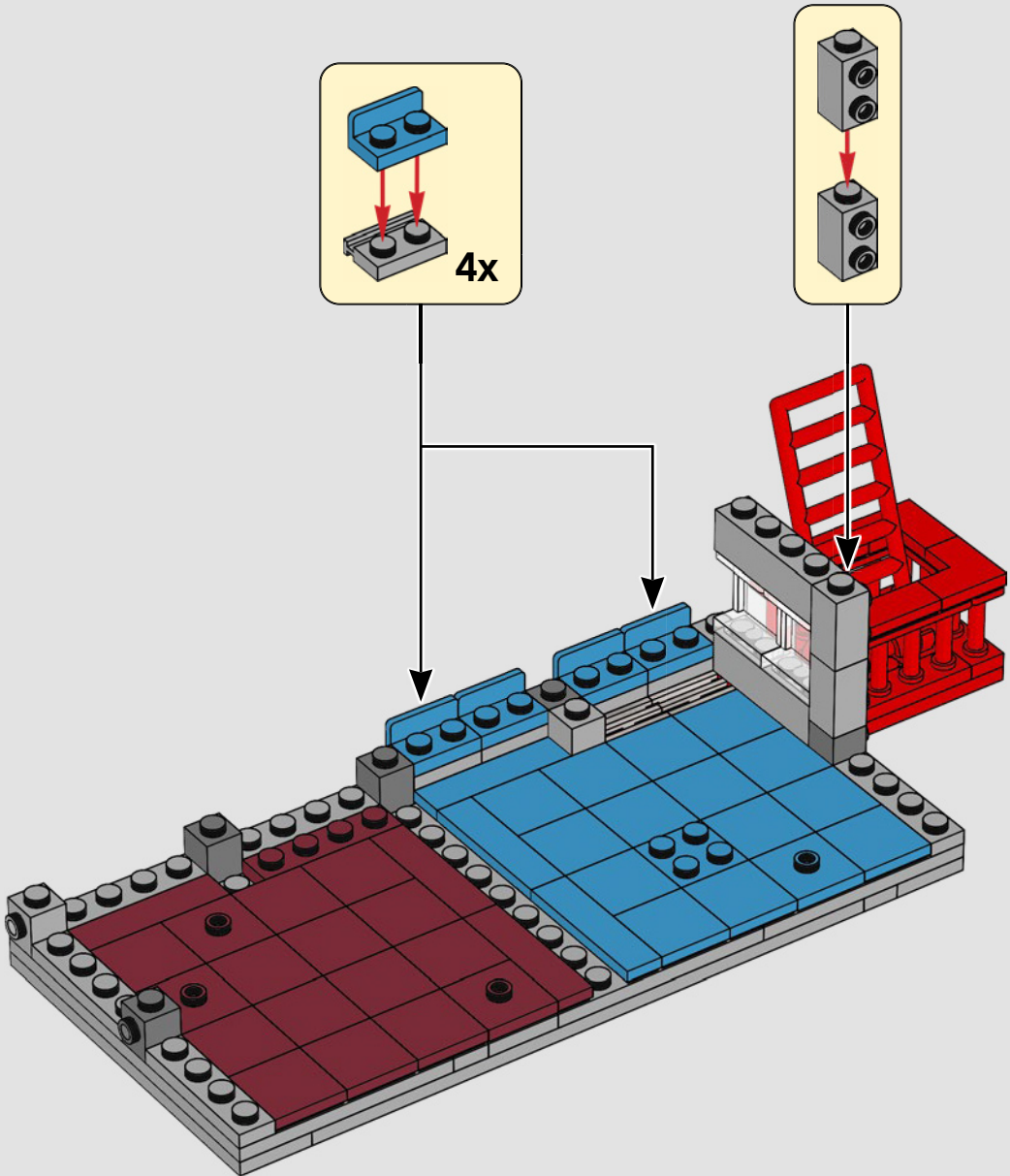



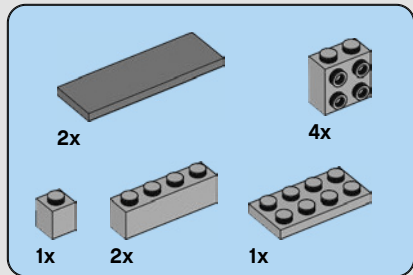

398

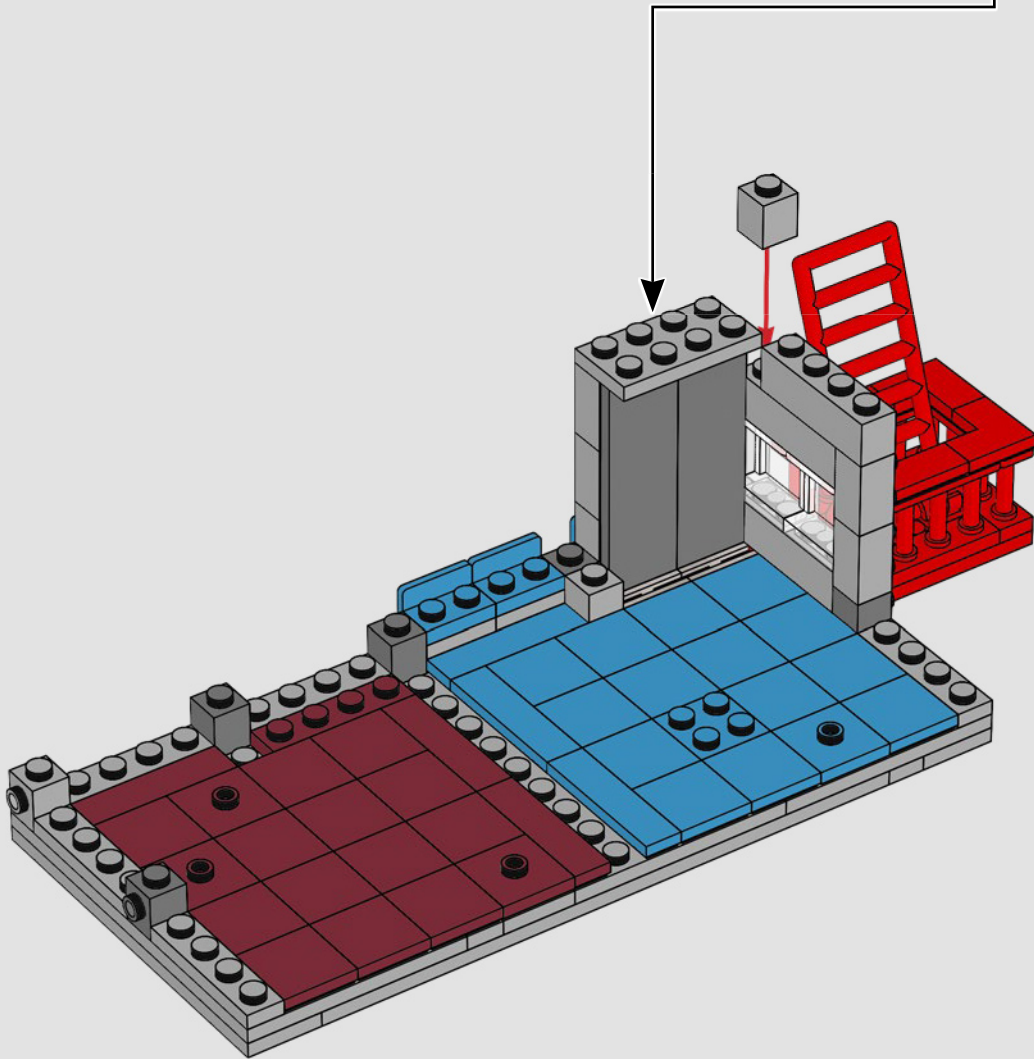
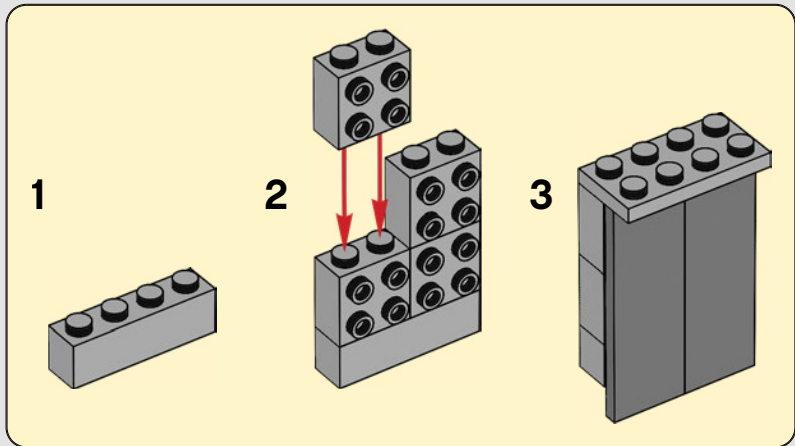

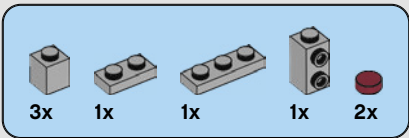

399

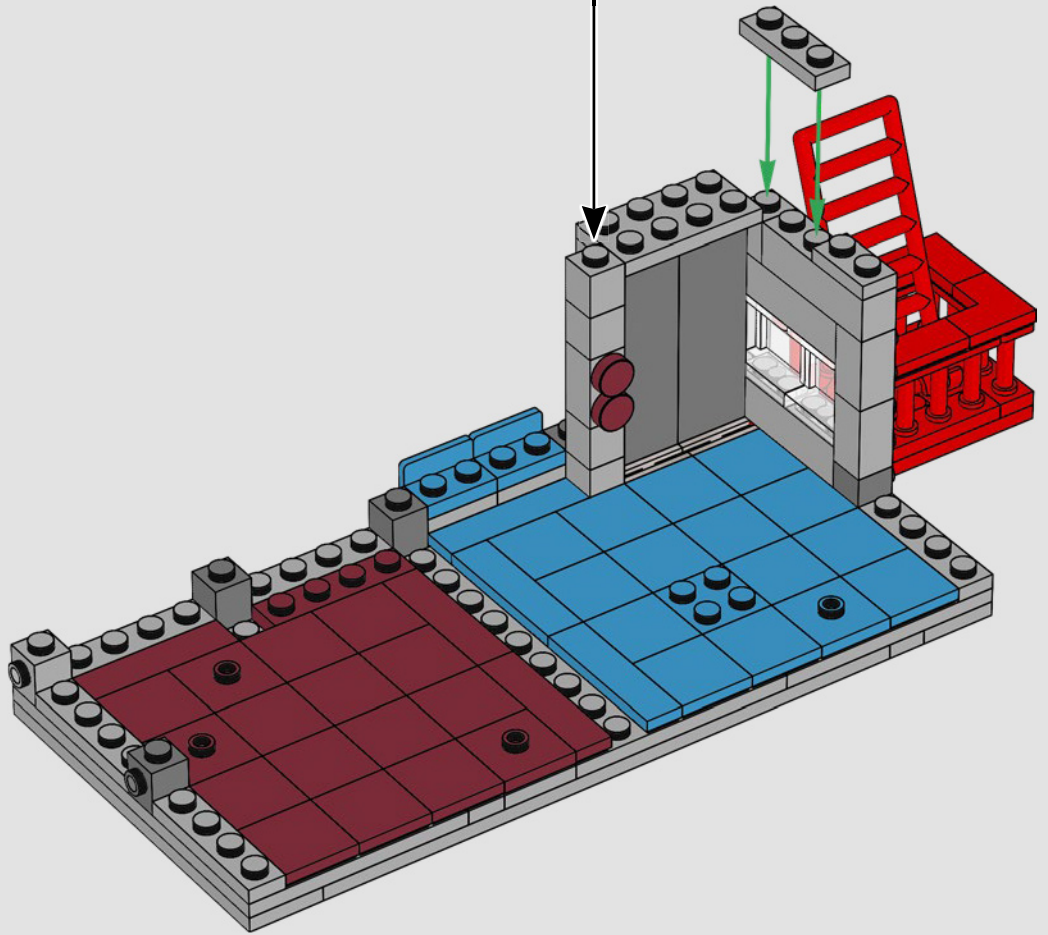
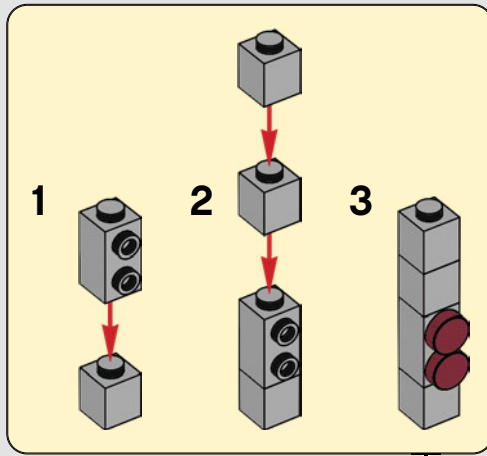

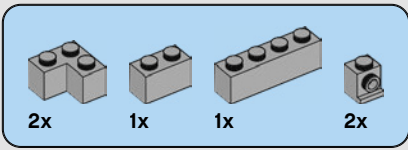

400

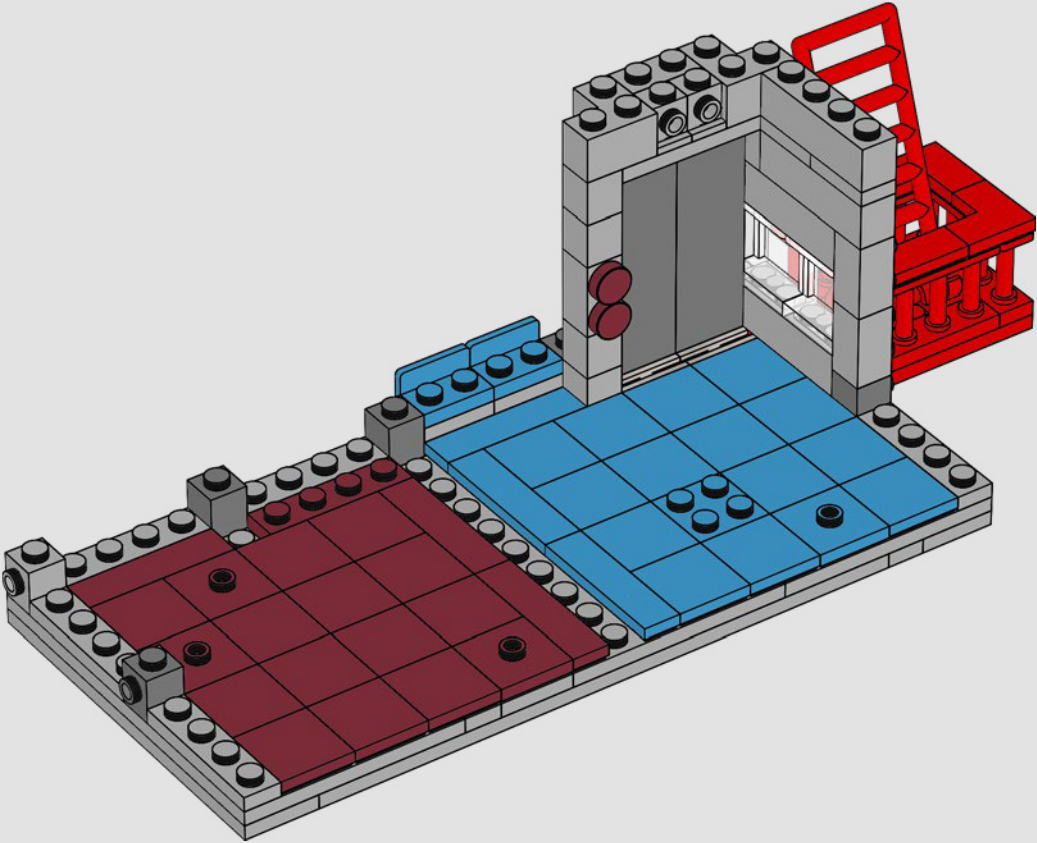



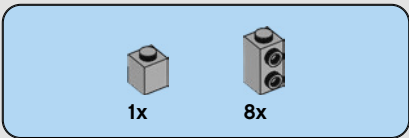

401

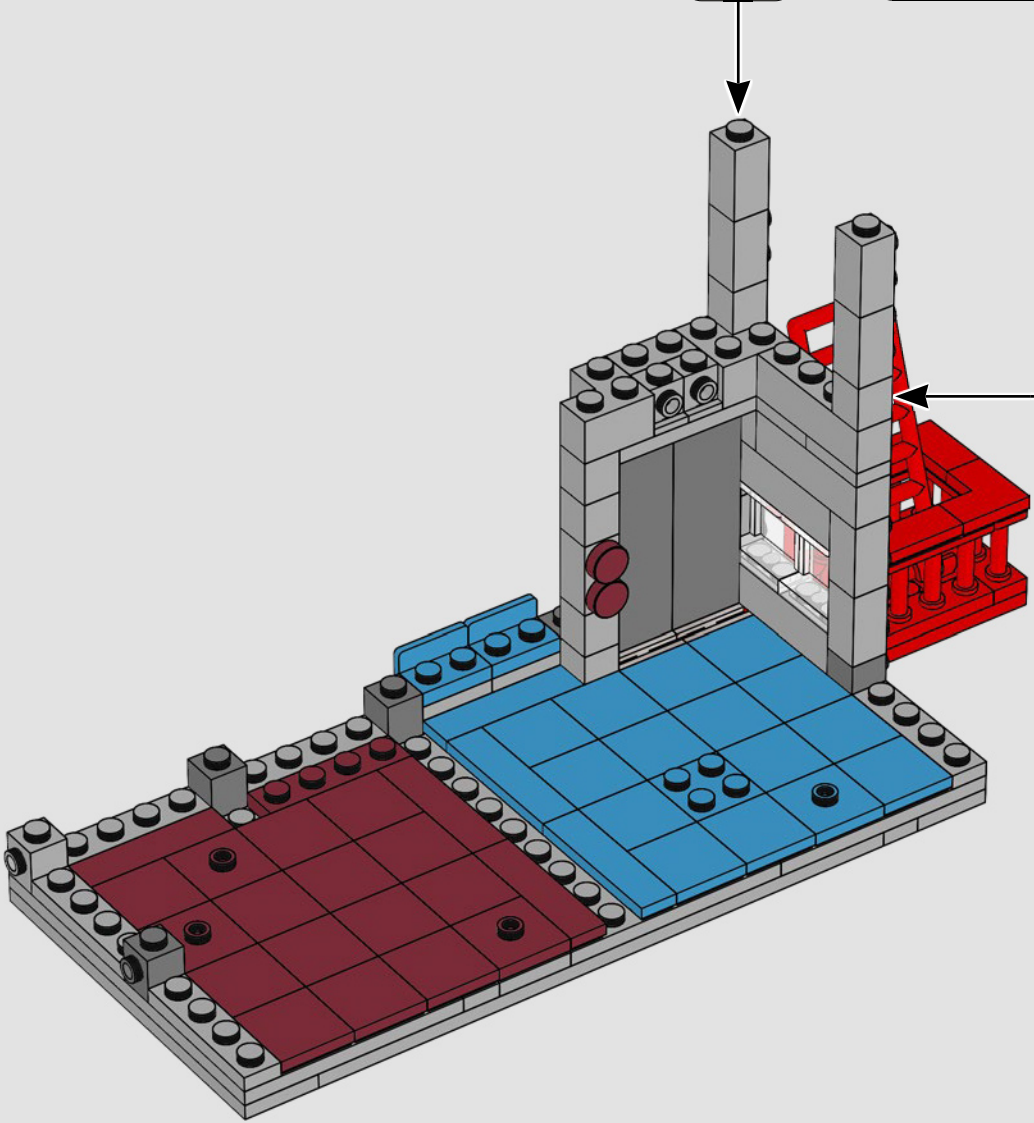
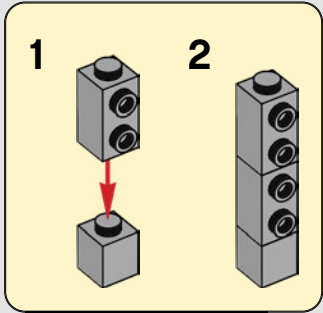
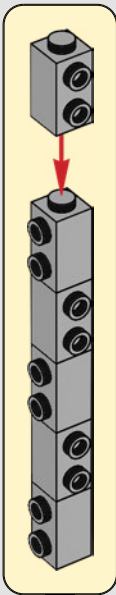

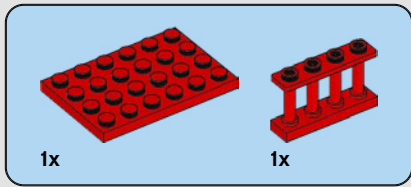

402

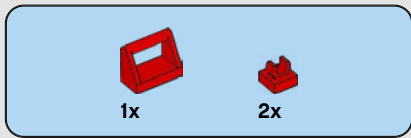
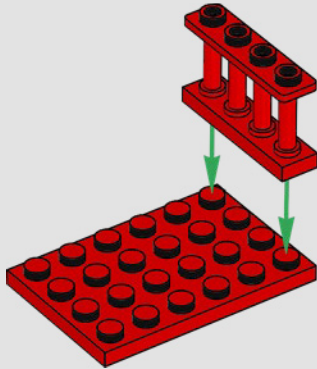

403

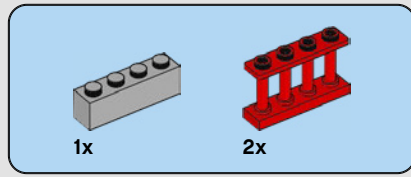
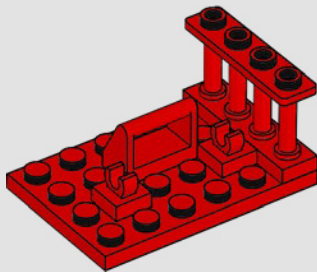

404

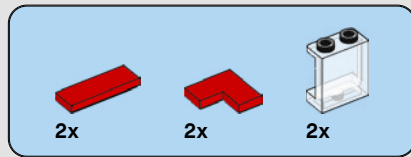
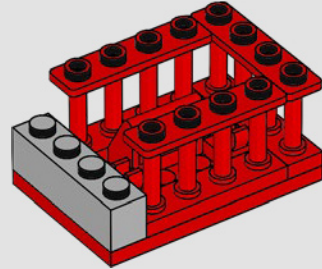

405

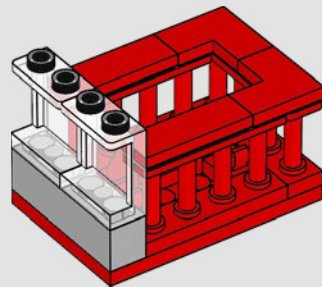

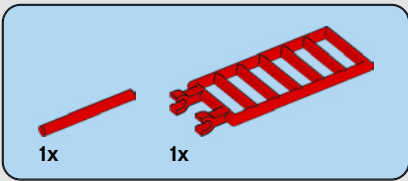

406

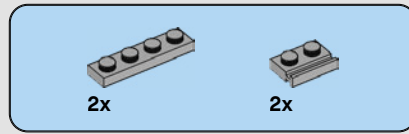
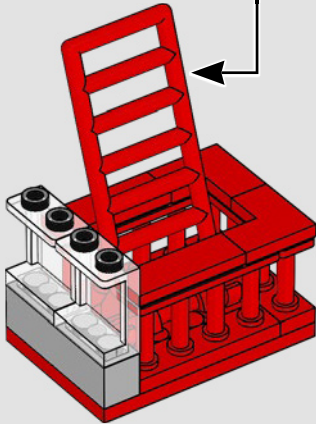
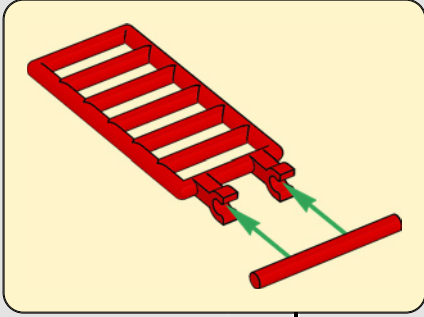

407

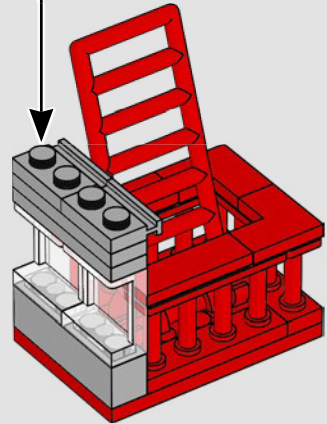
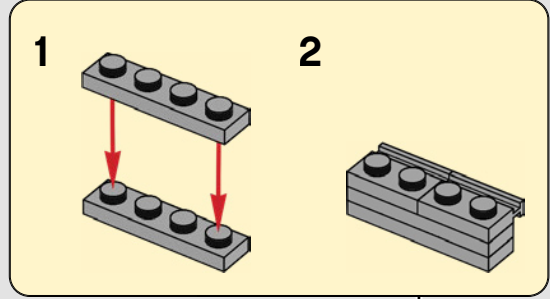

408

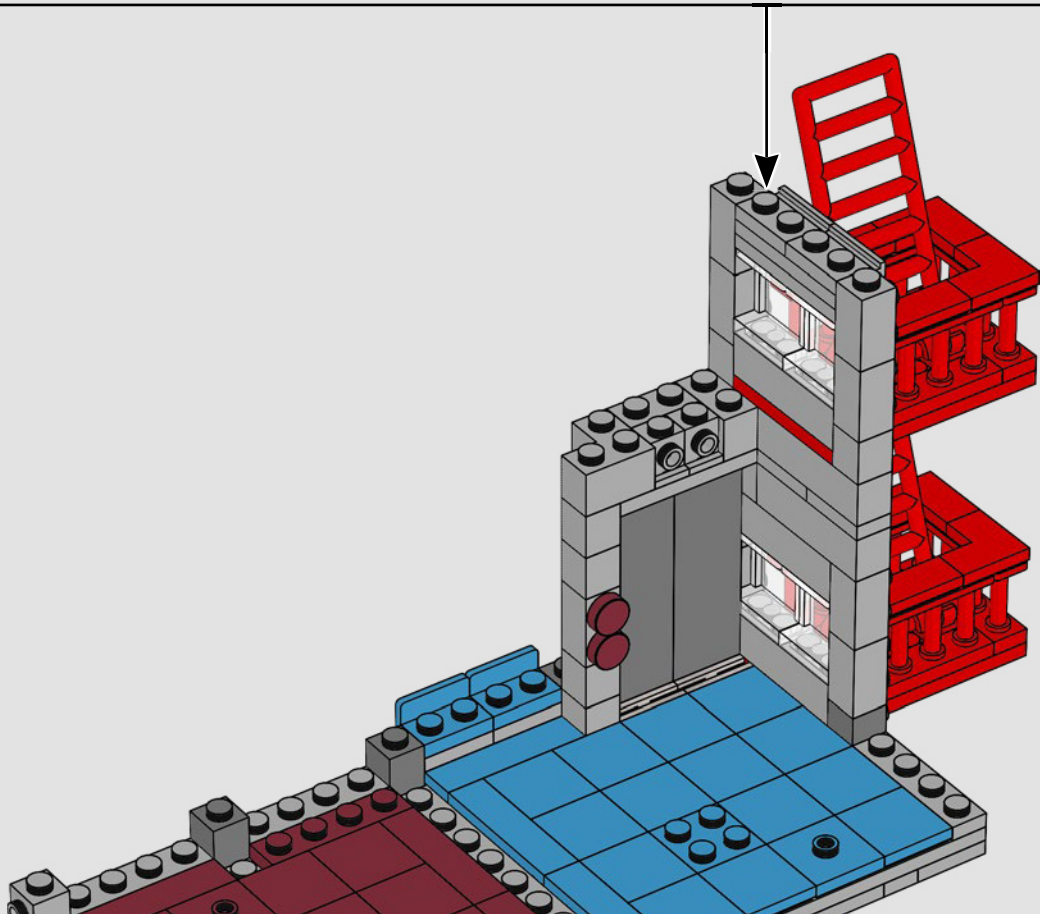



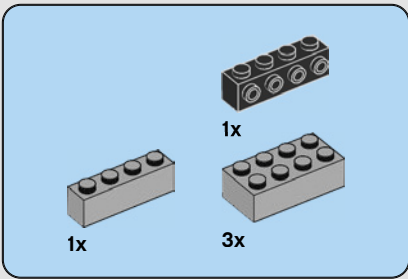

409

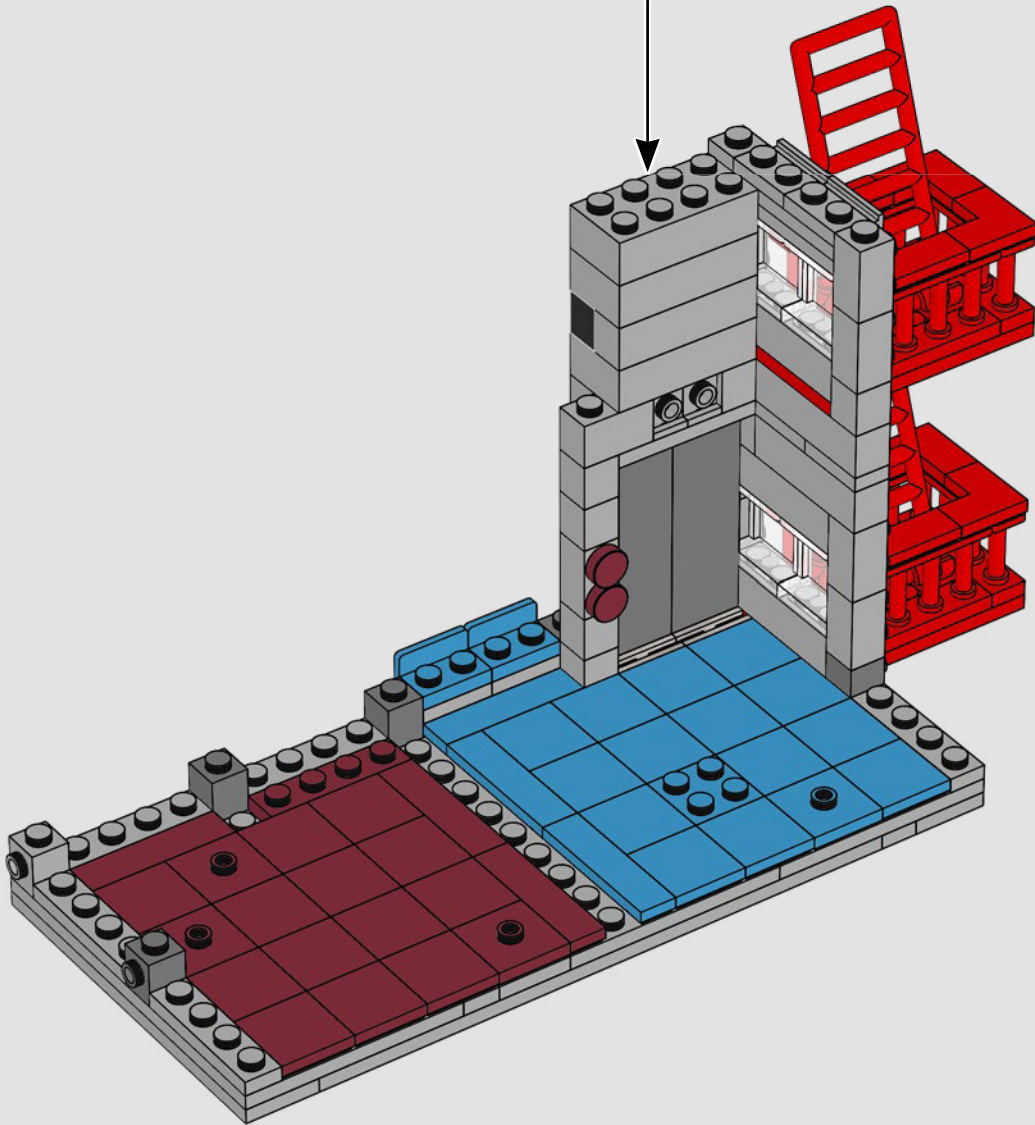
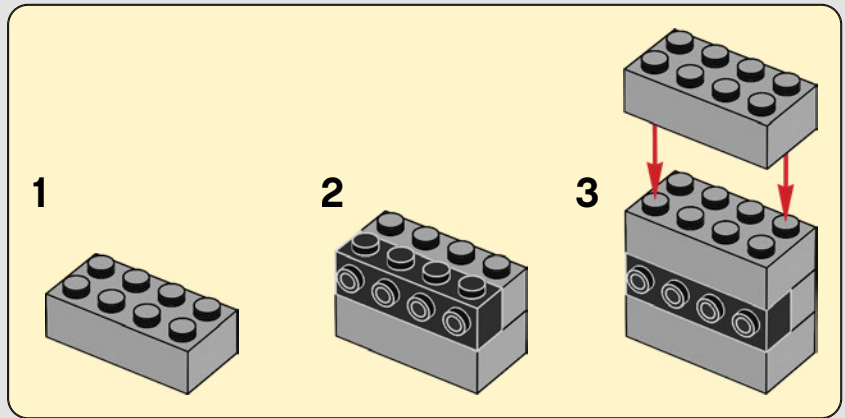

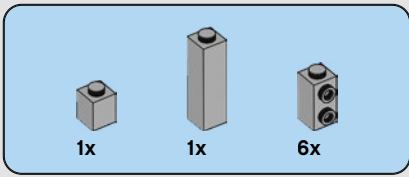

410

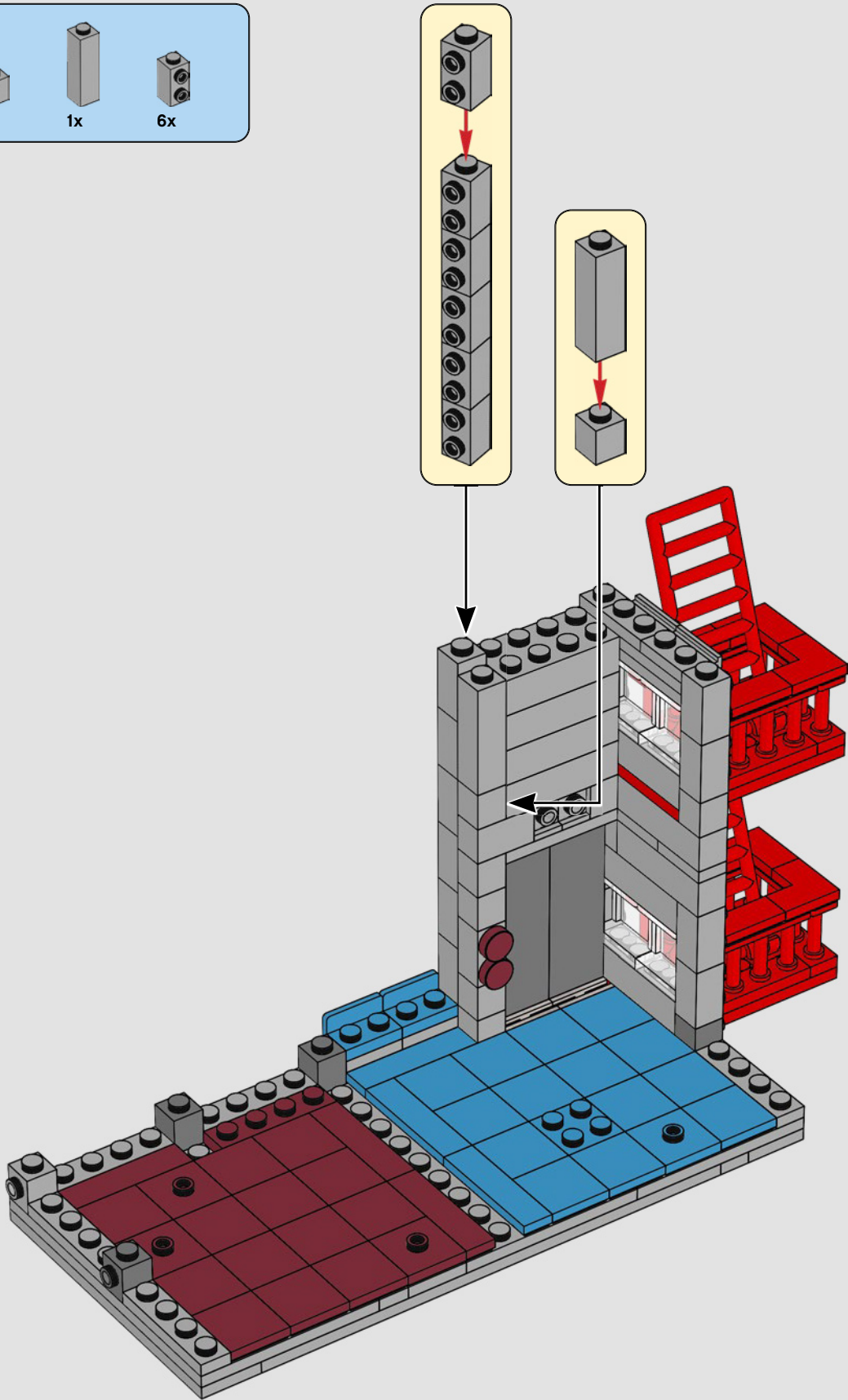

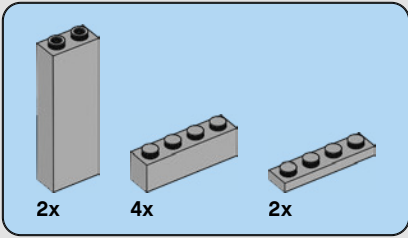

411

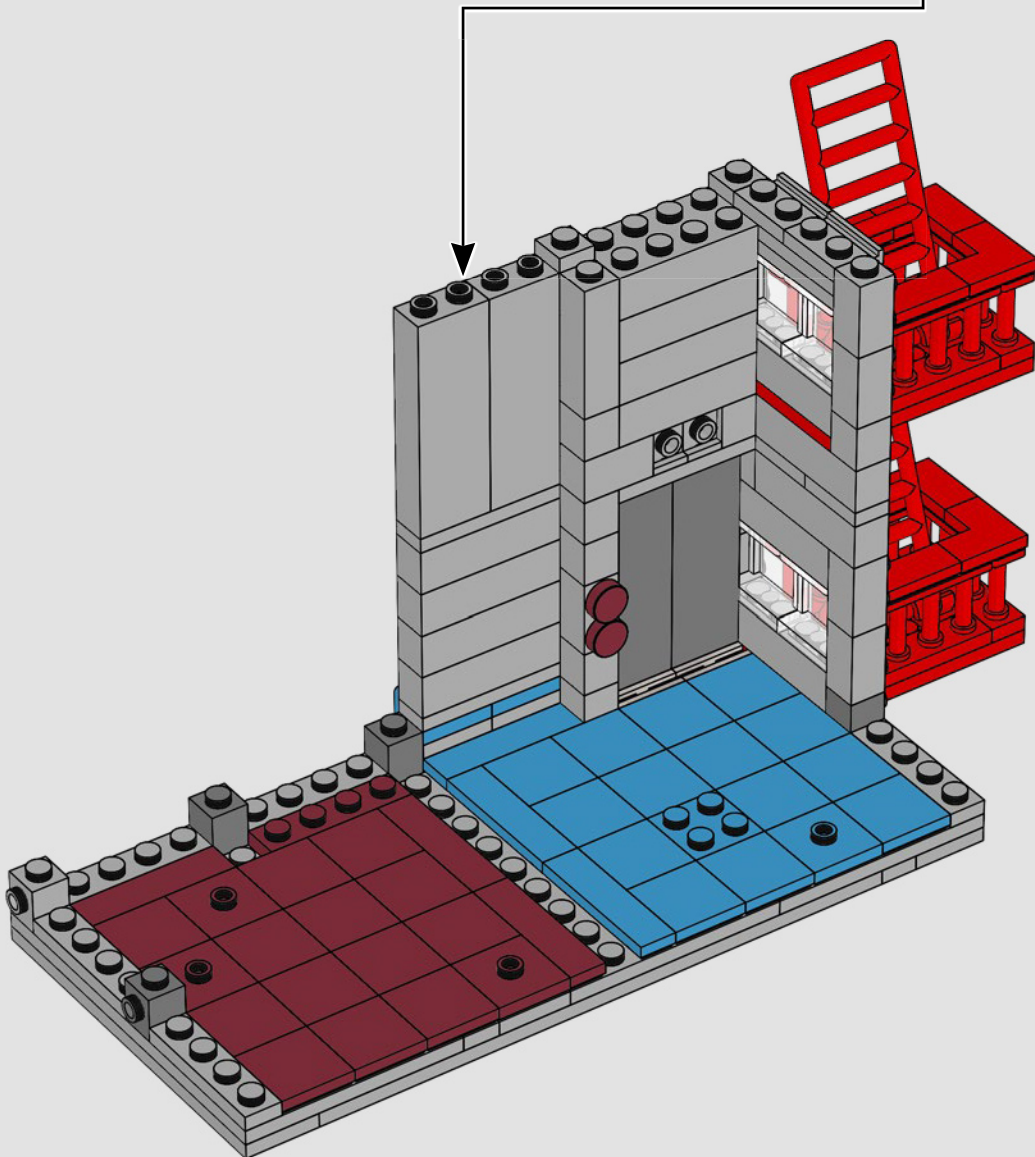
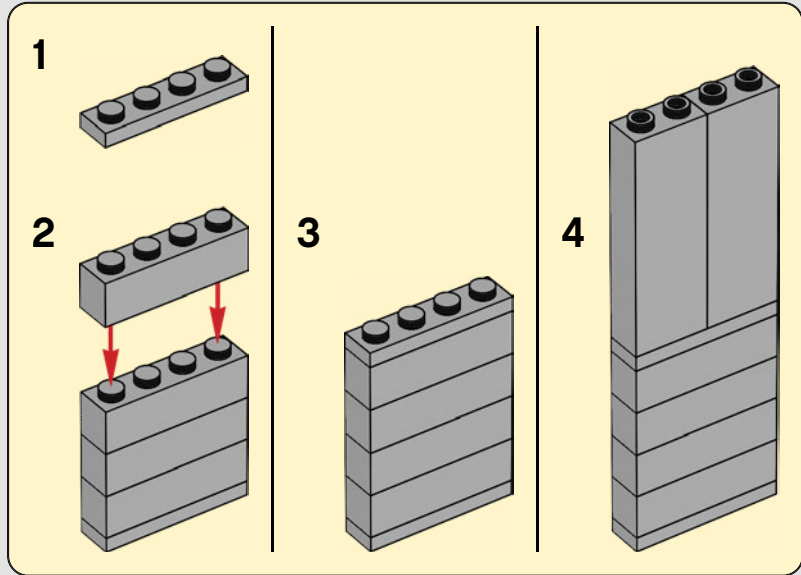



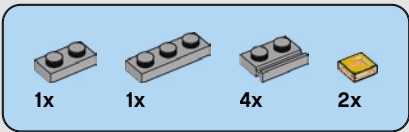

412

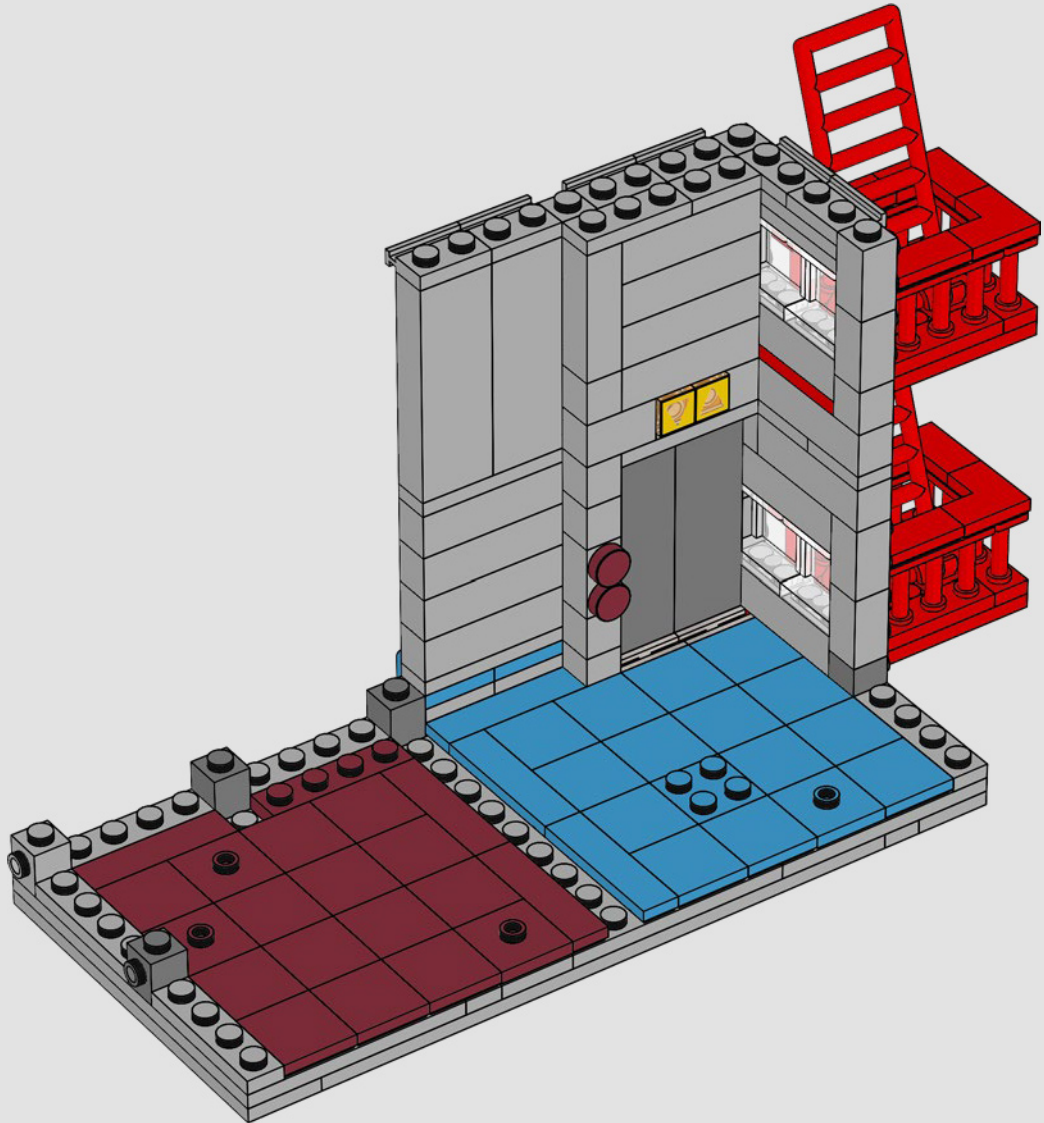

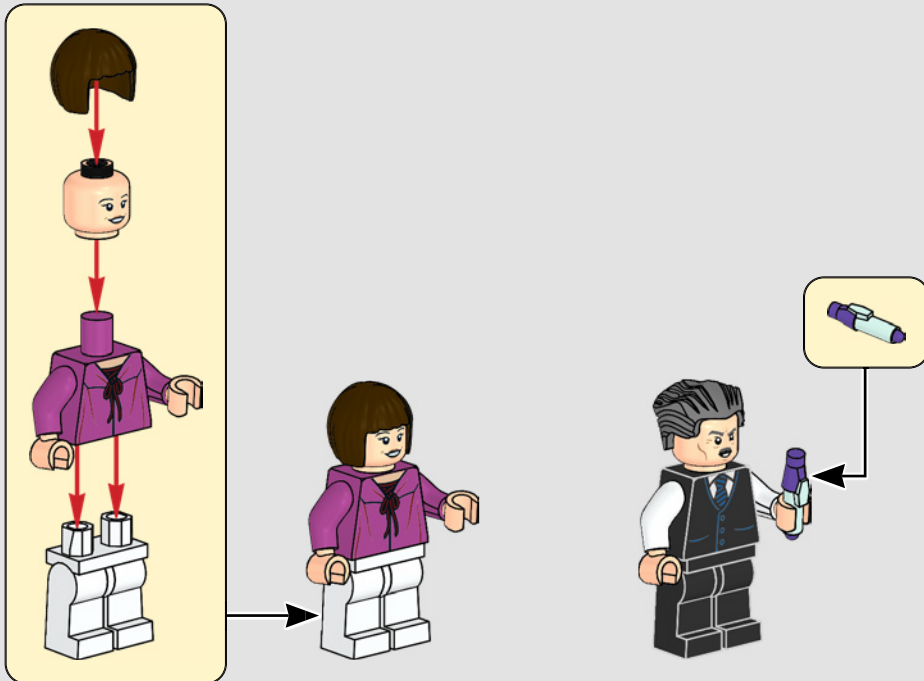
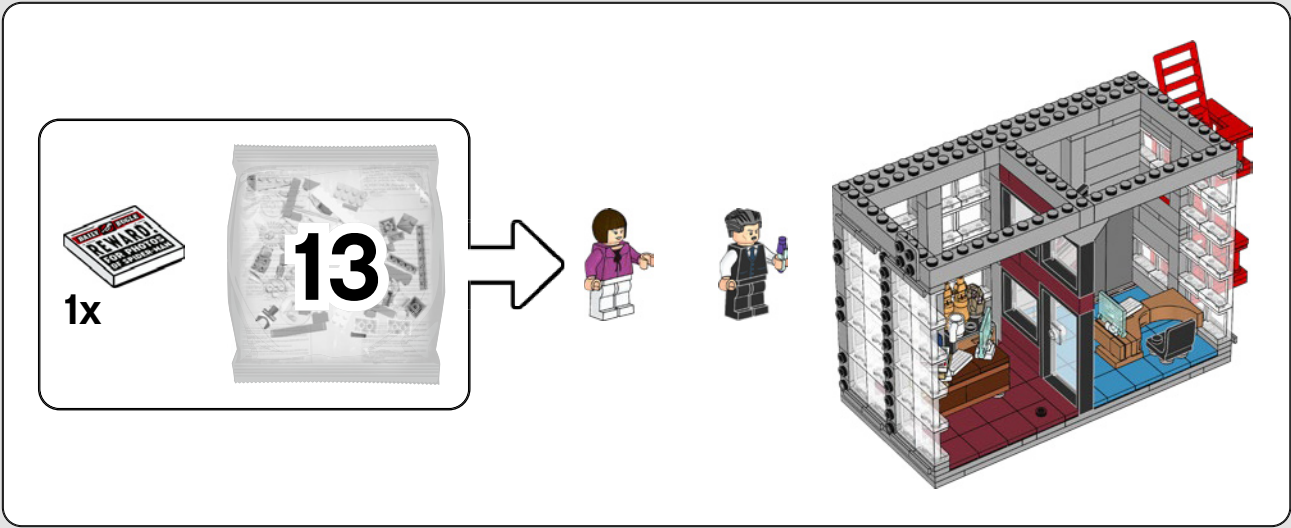

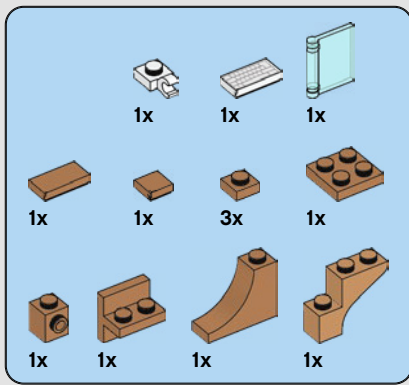

413

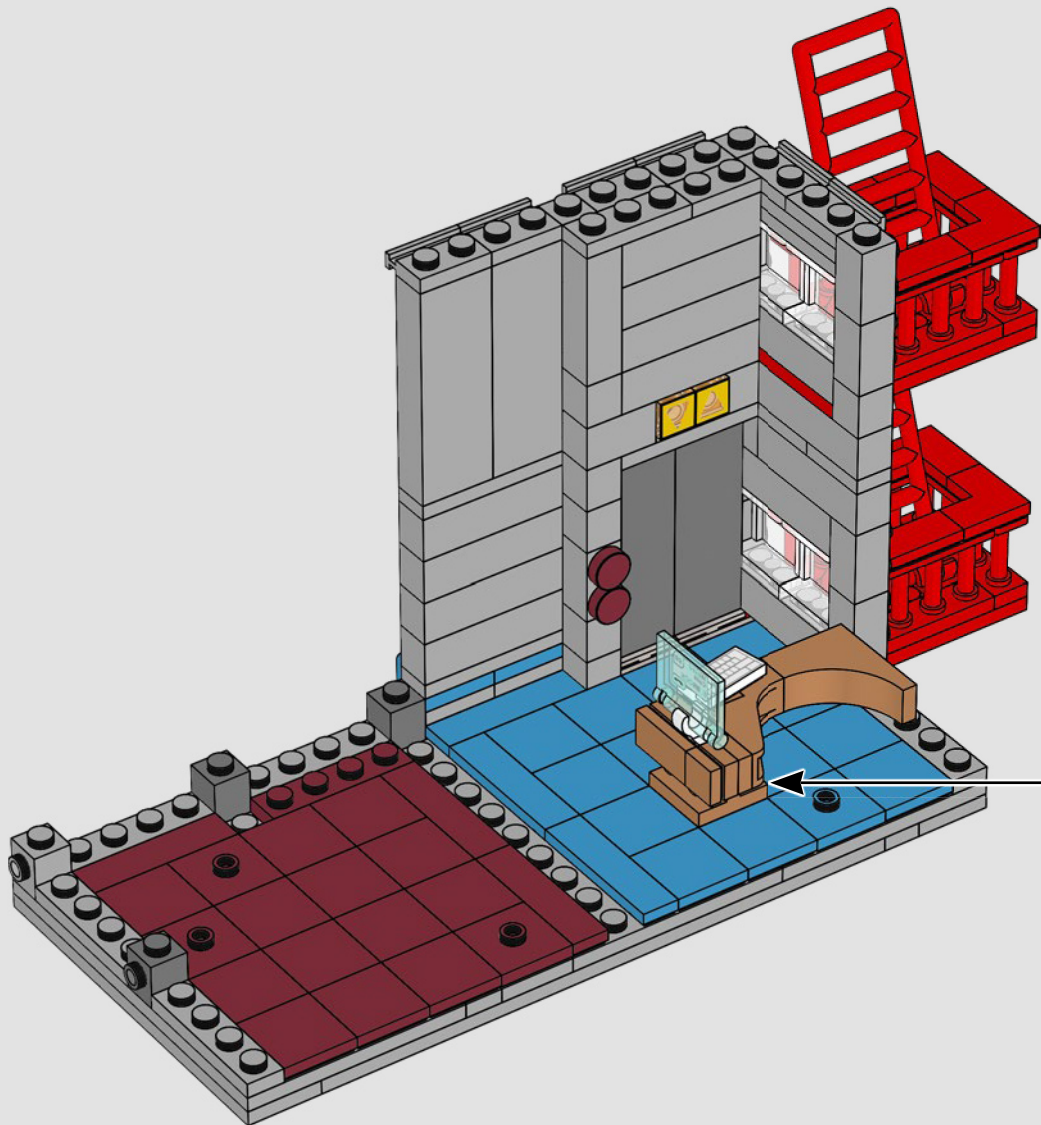
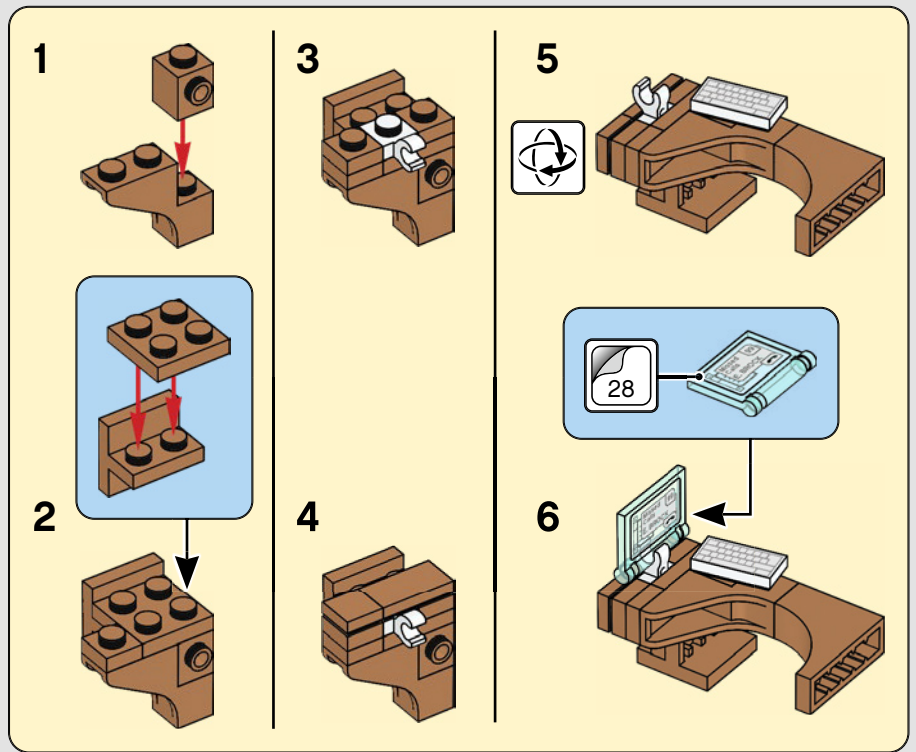



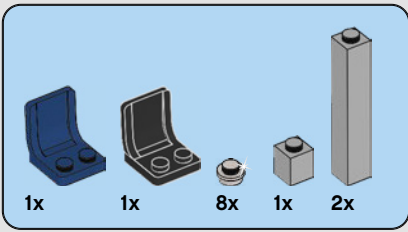

414

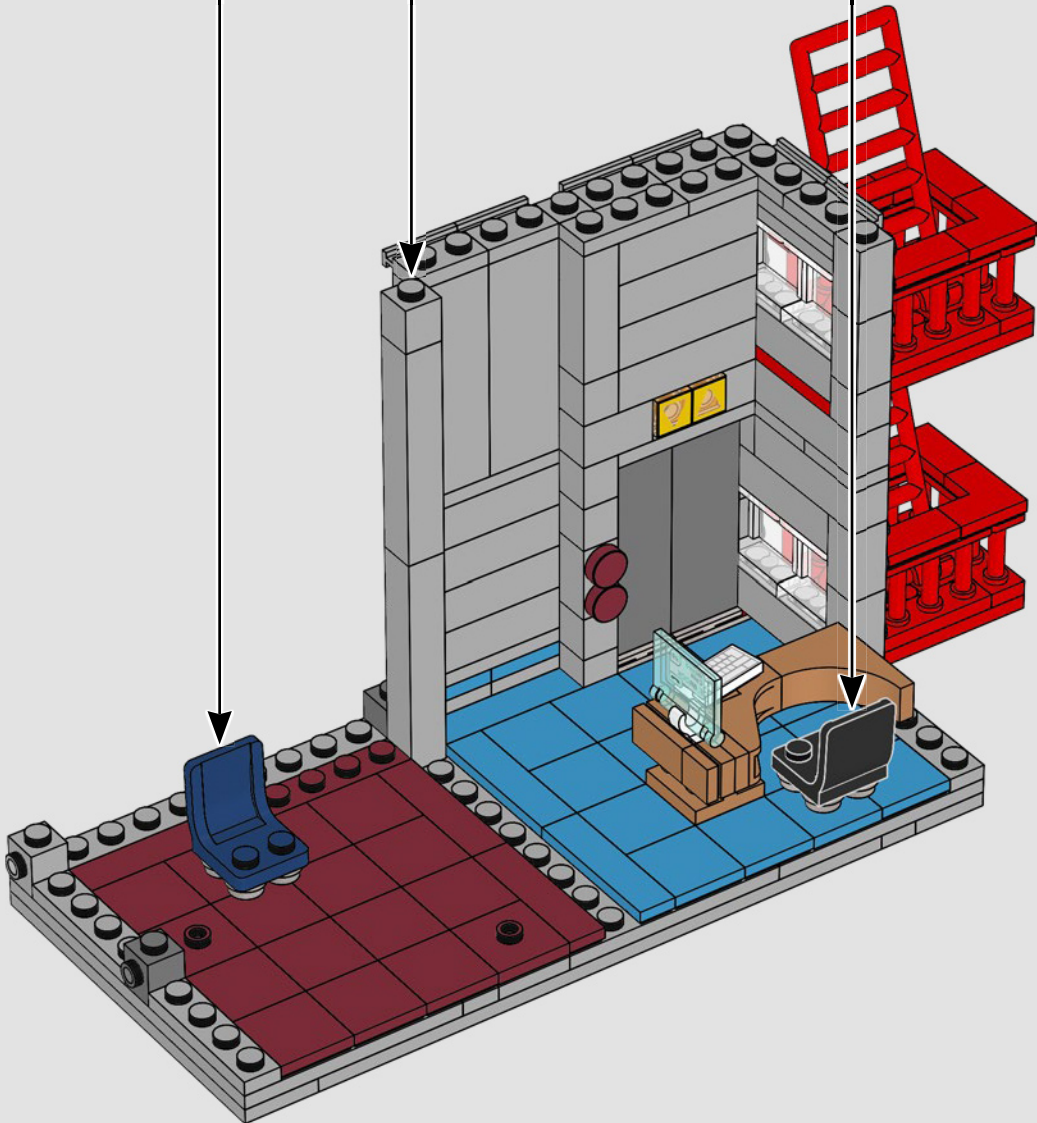
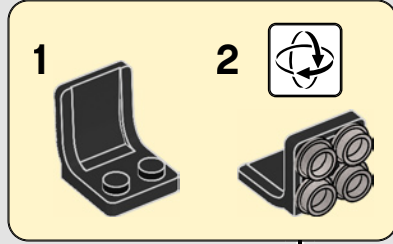
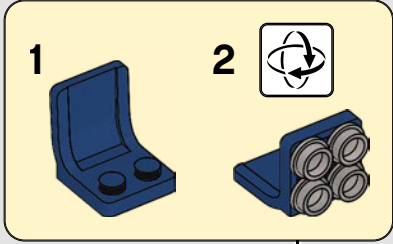
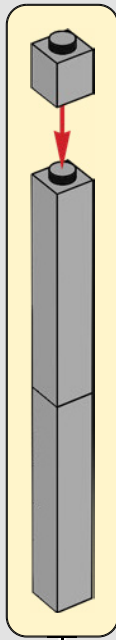

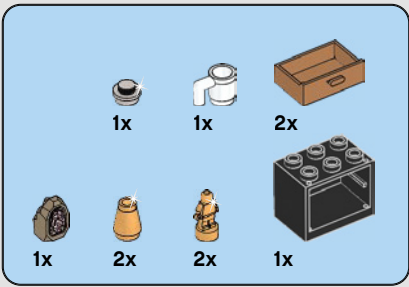

# 415

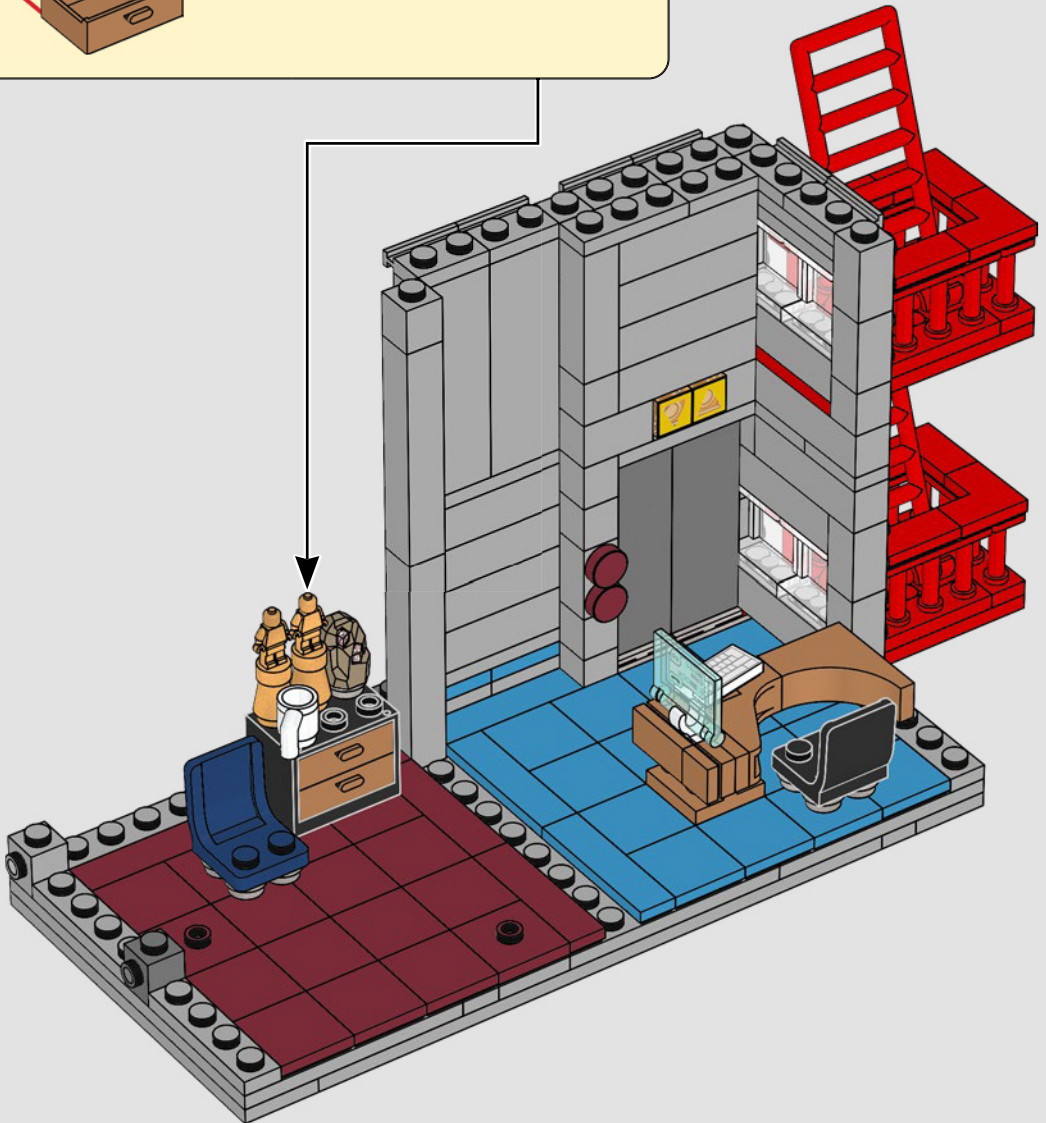
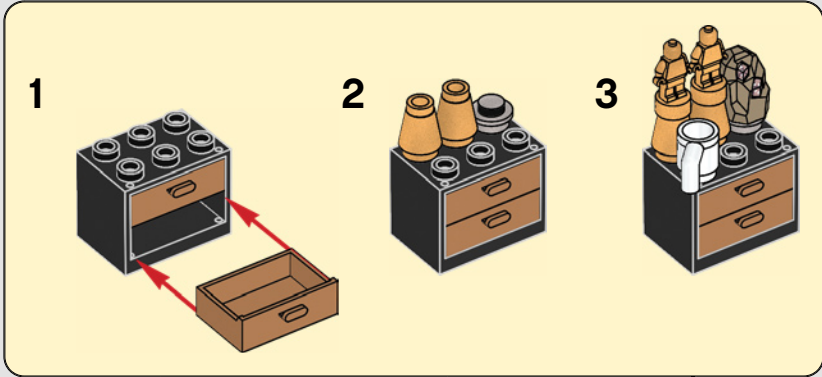

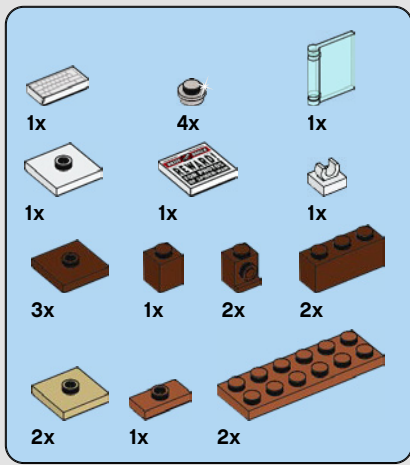

# 416

1

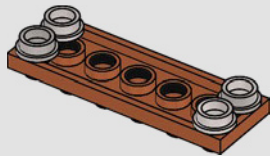

2

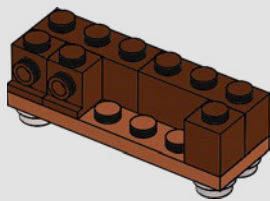

3

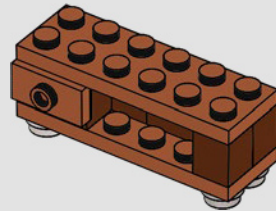

4

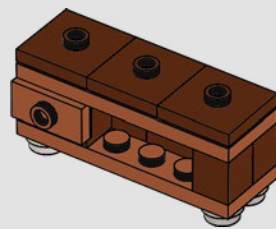



5

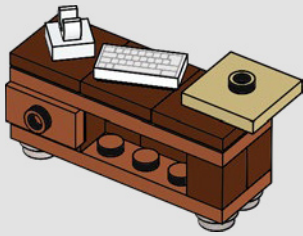

6

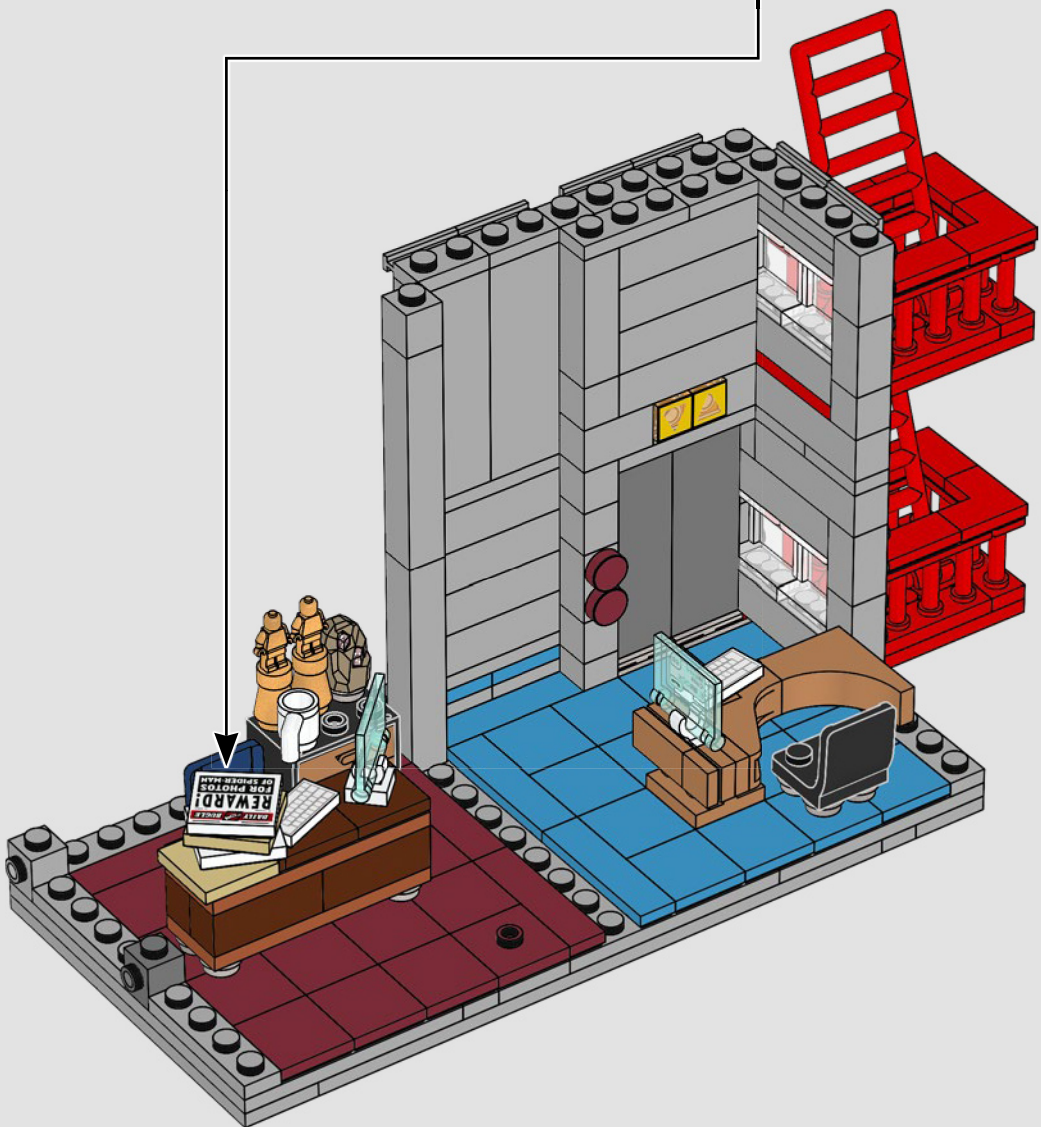
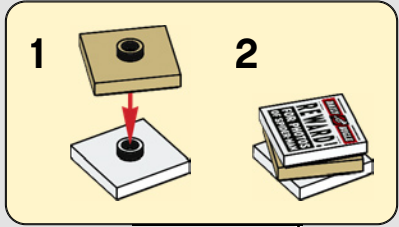
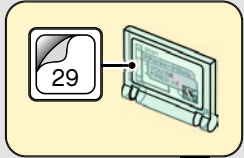

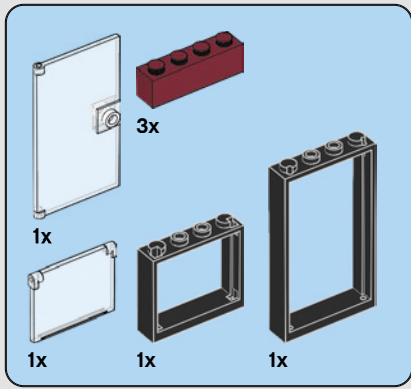

417

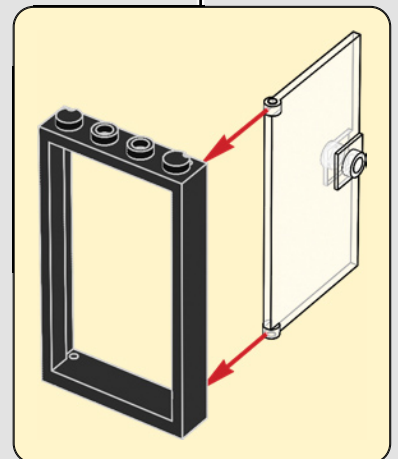
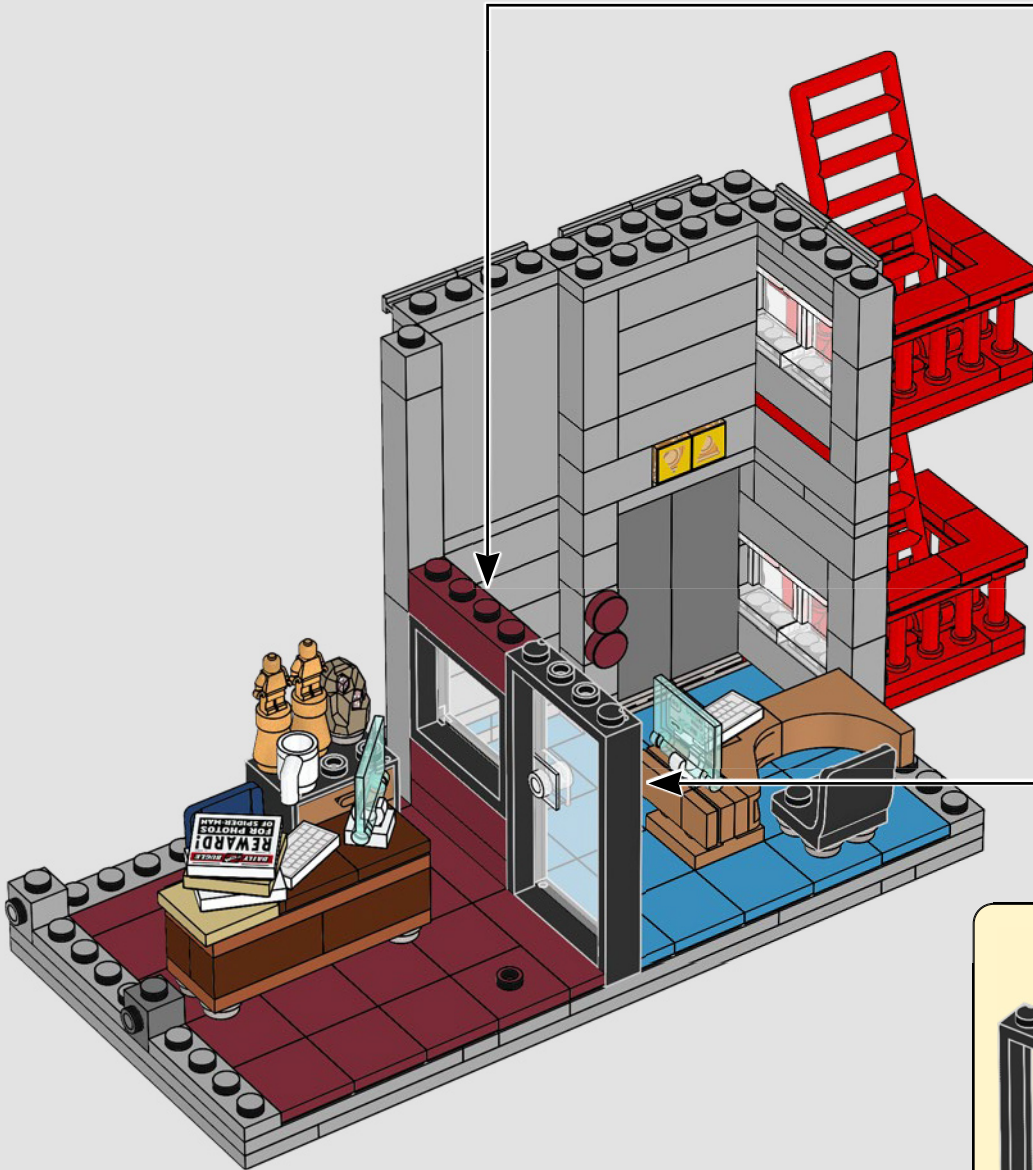
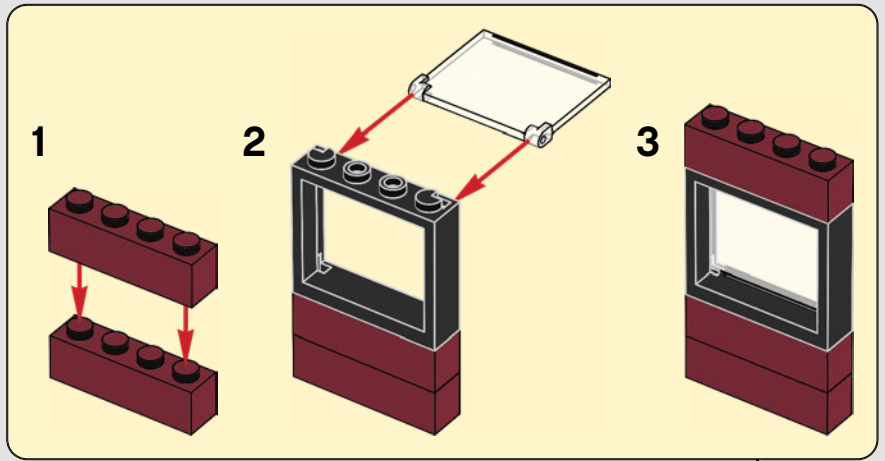

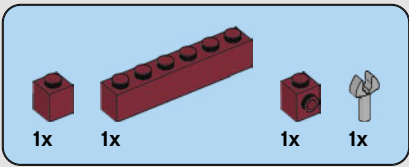

# 418

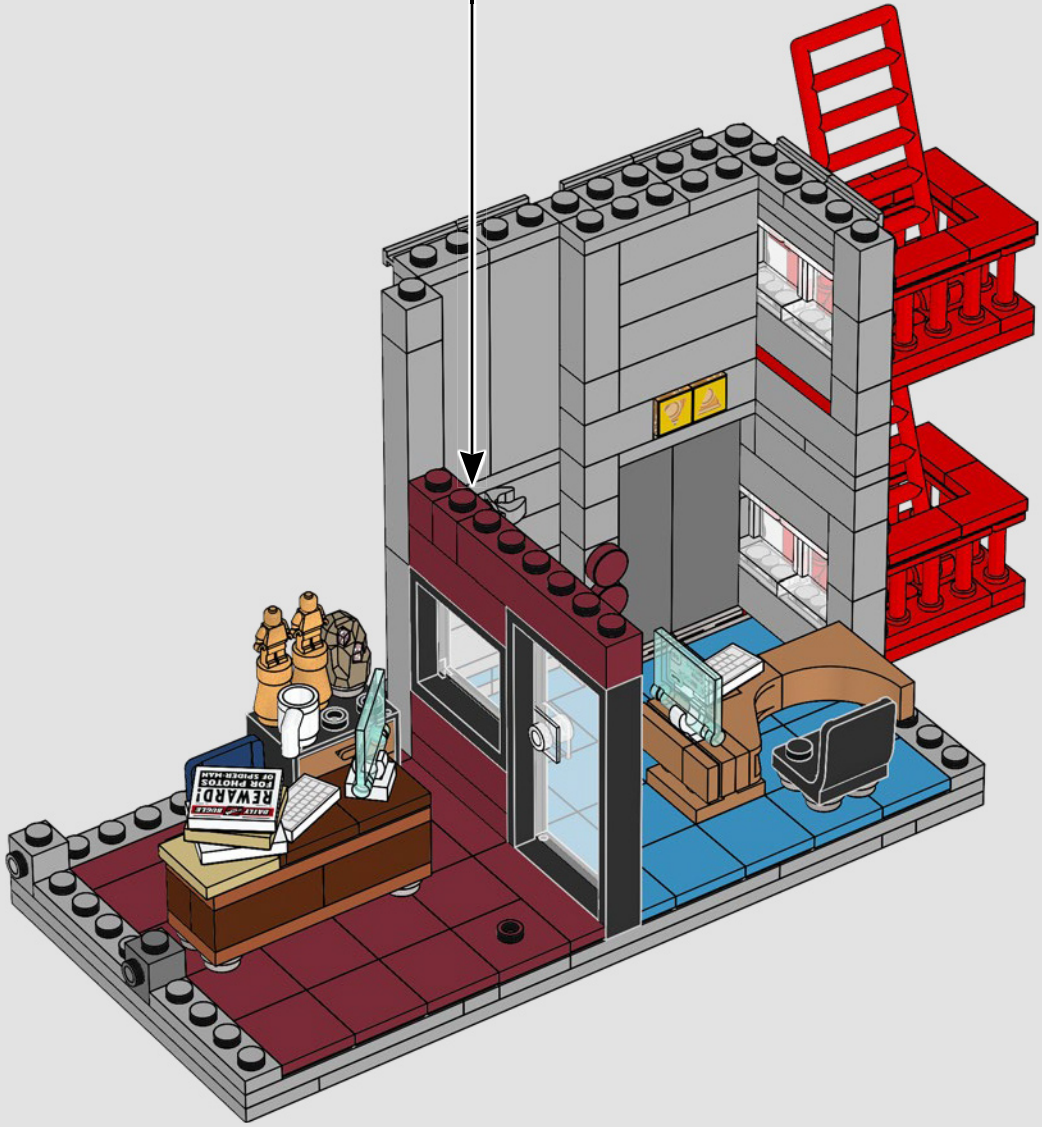
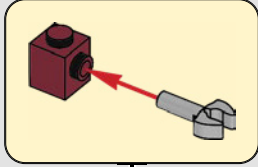



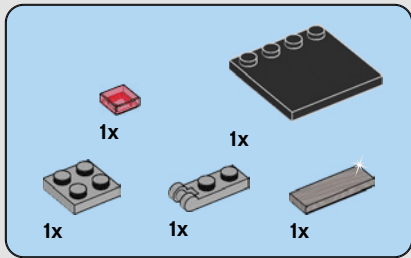

# 419

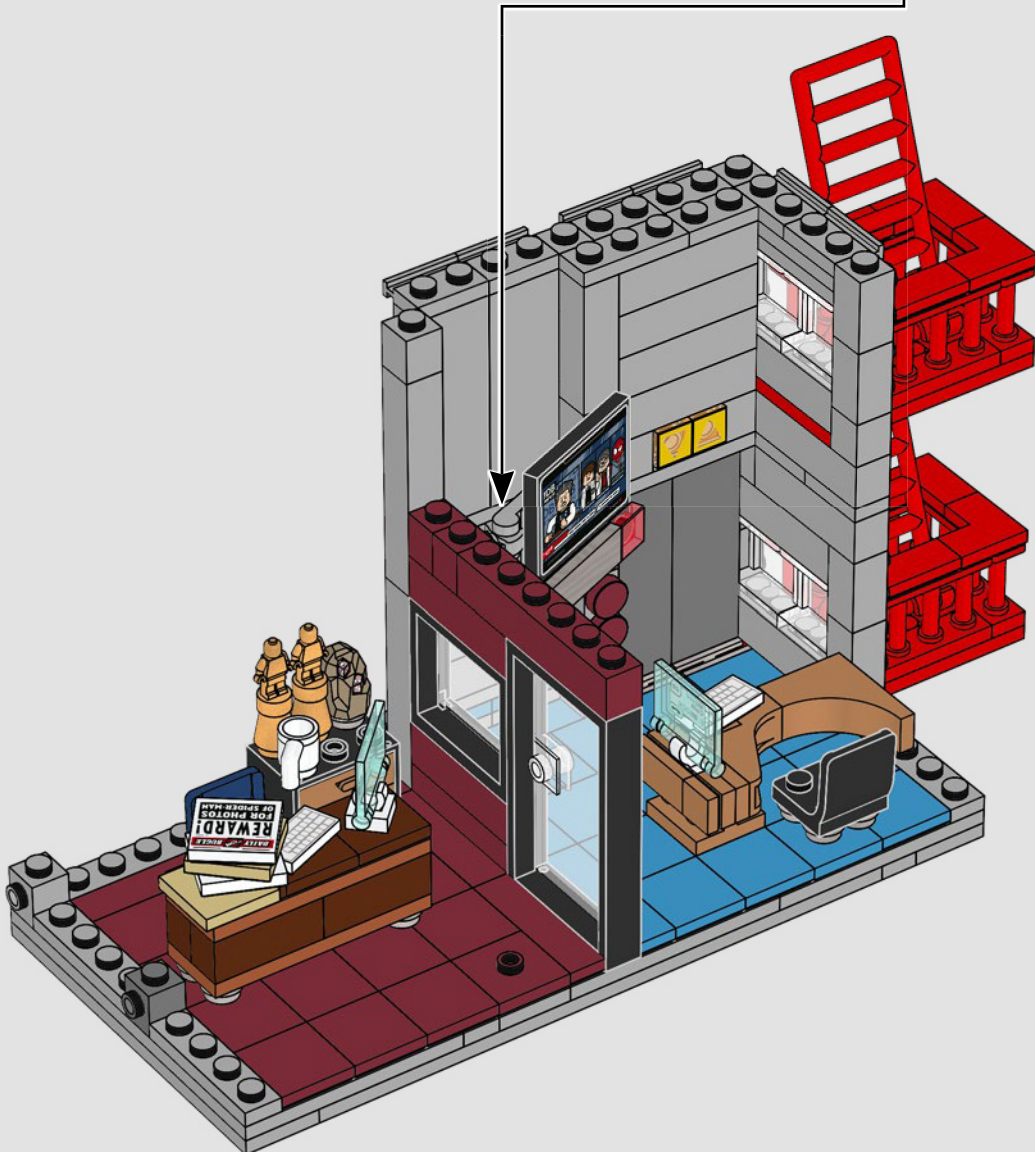
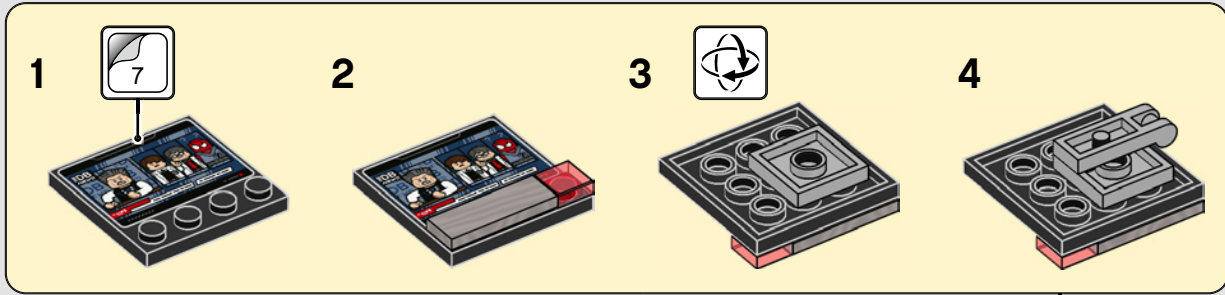

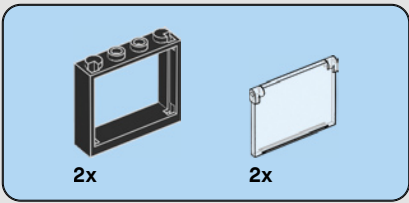

420

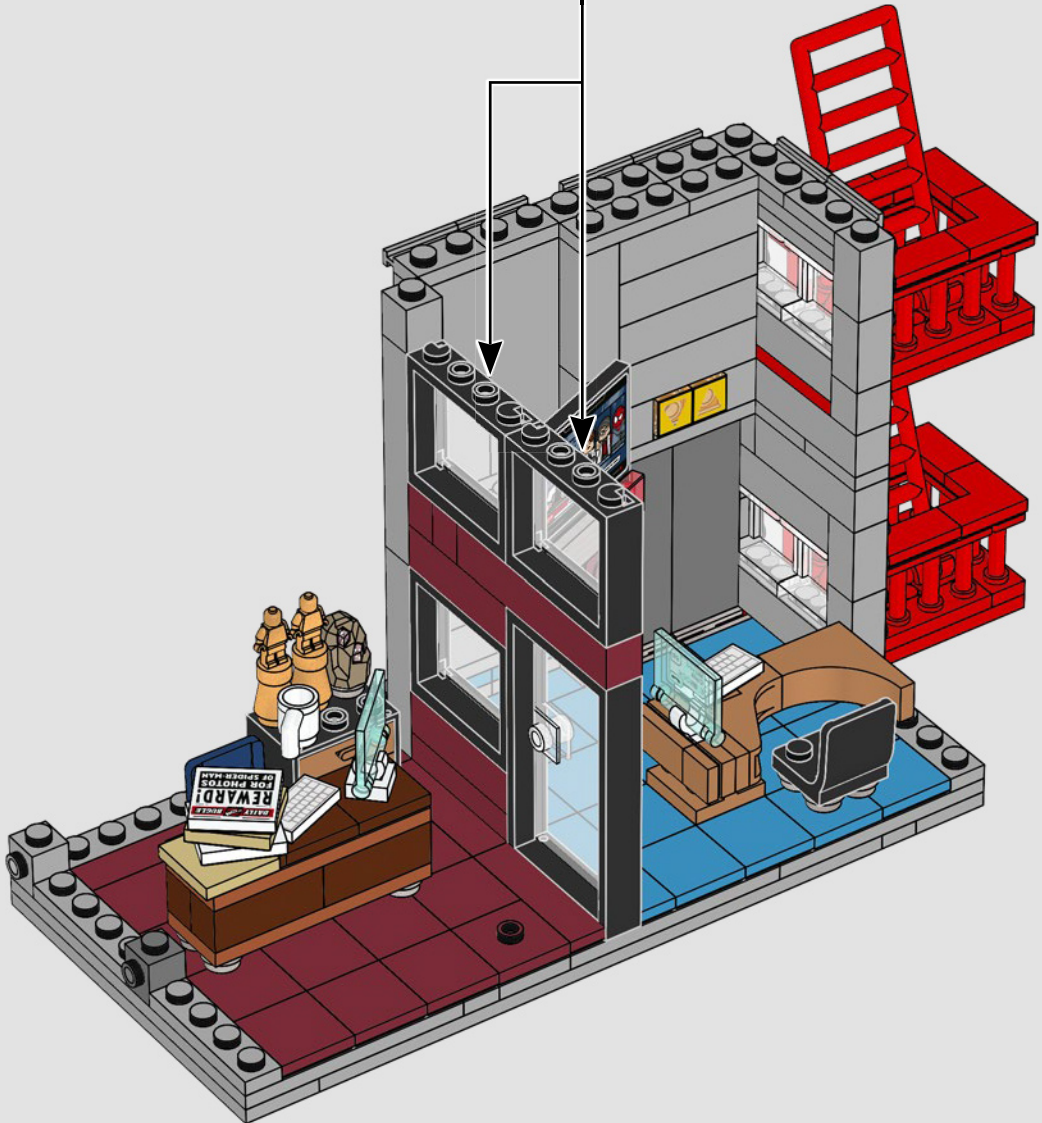
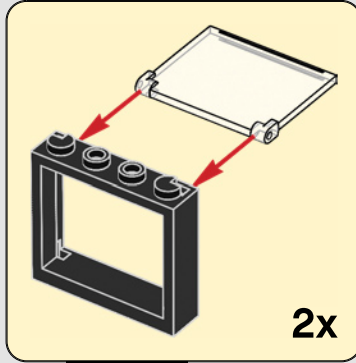

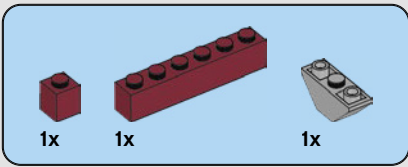

421

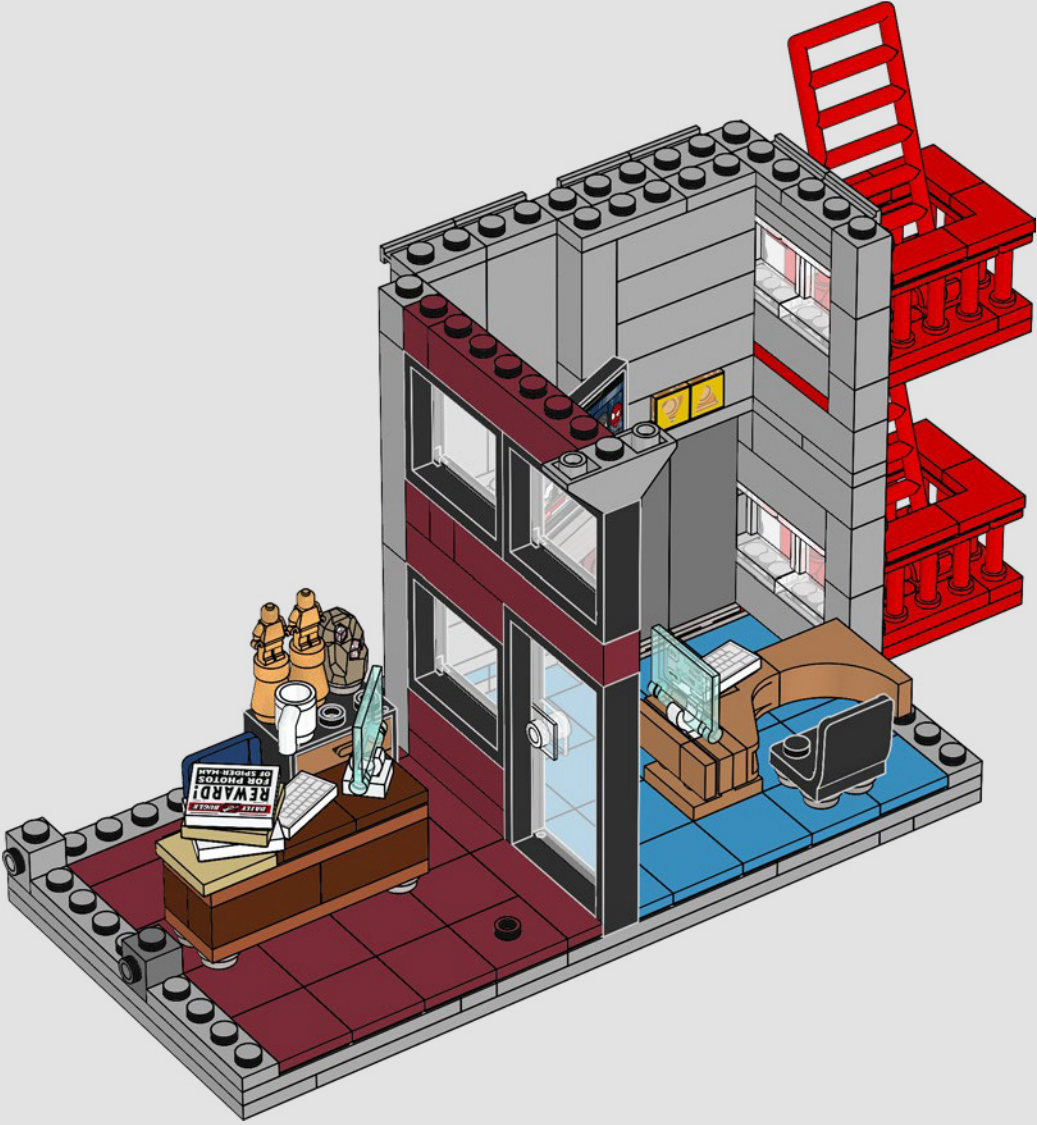





24x

# 422



3x

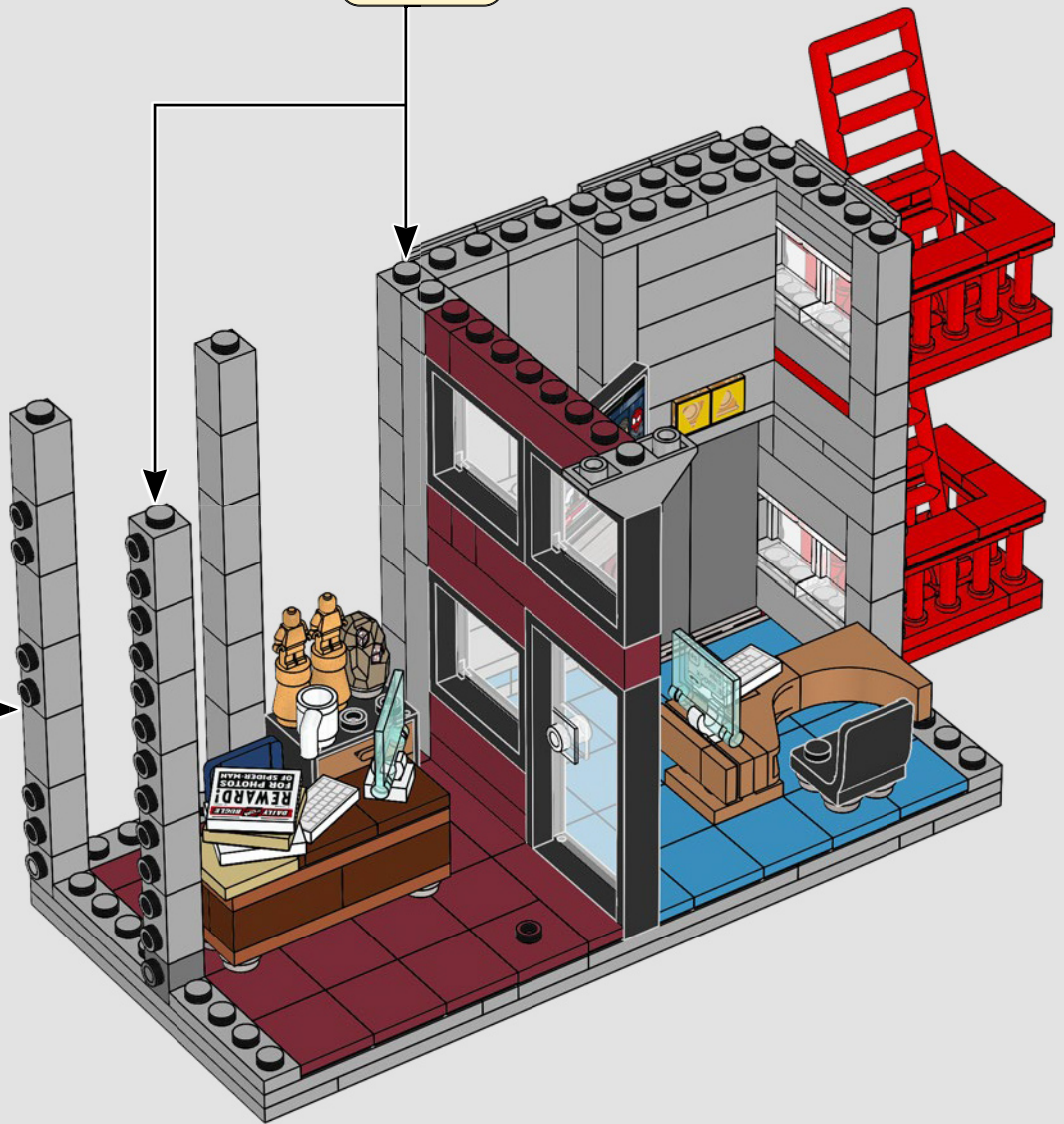
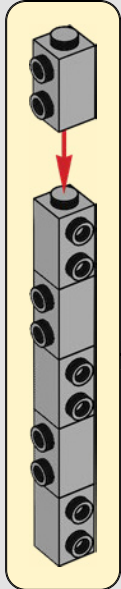

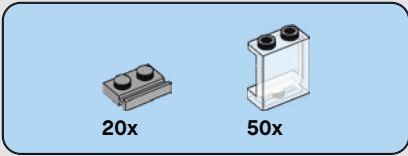

423

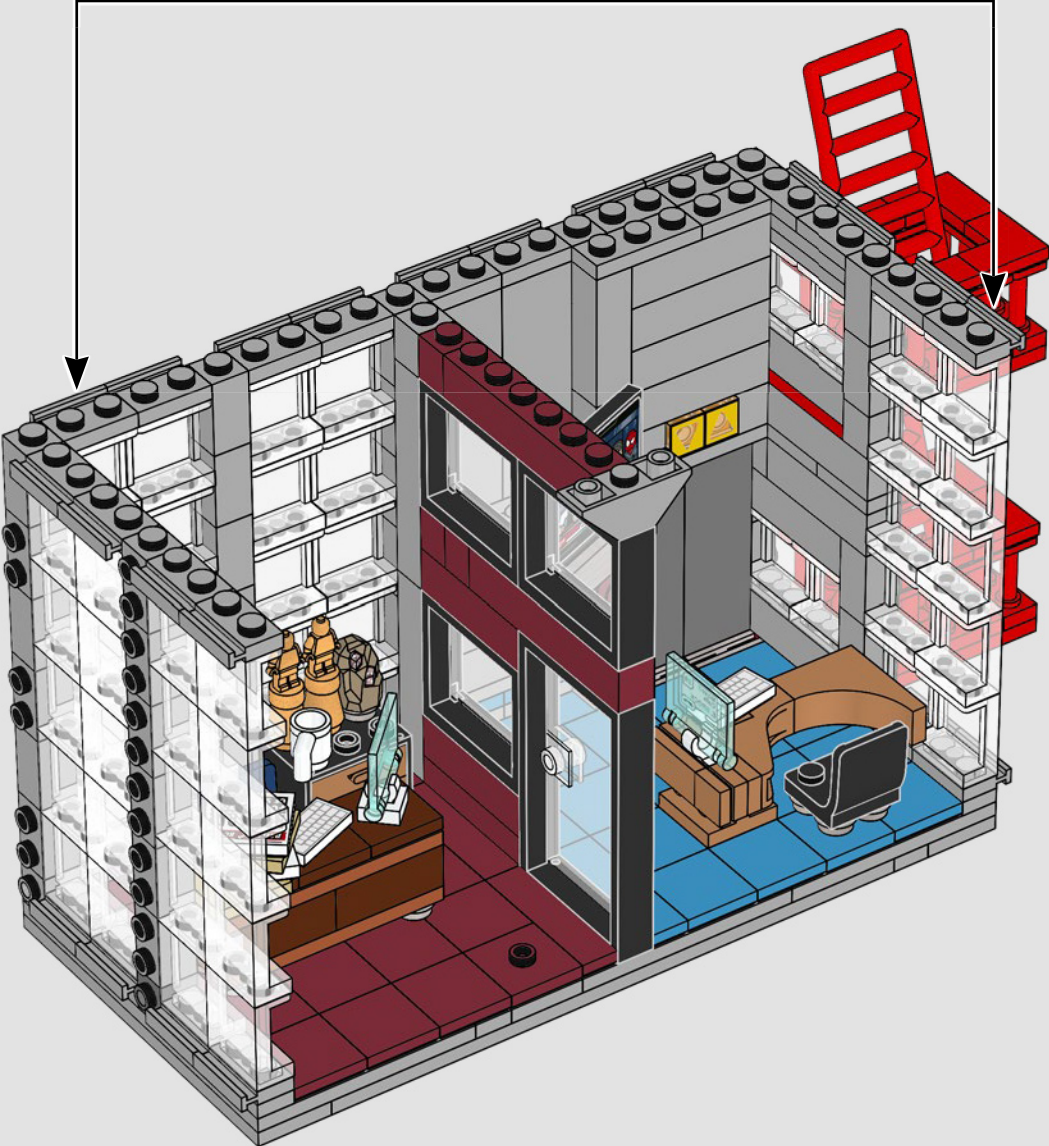
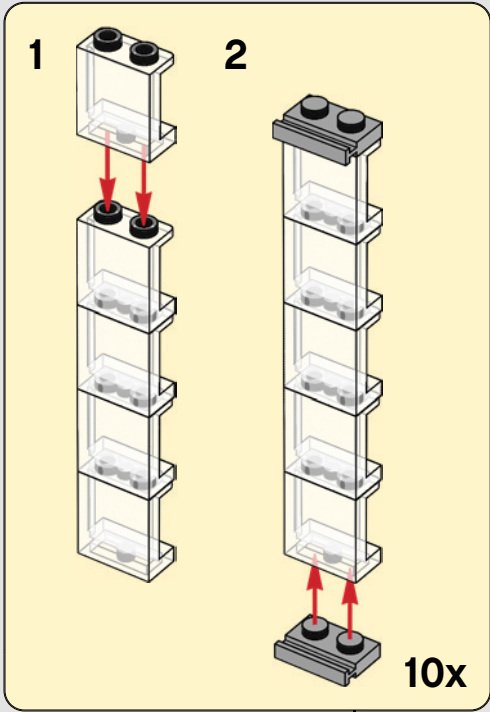



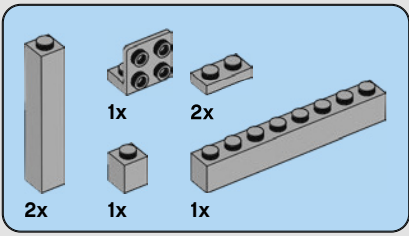

424

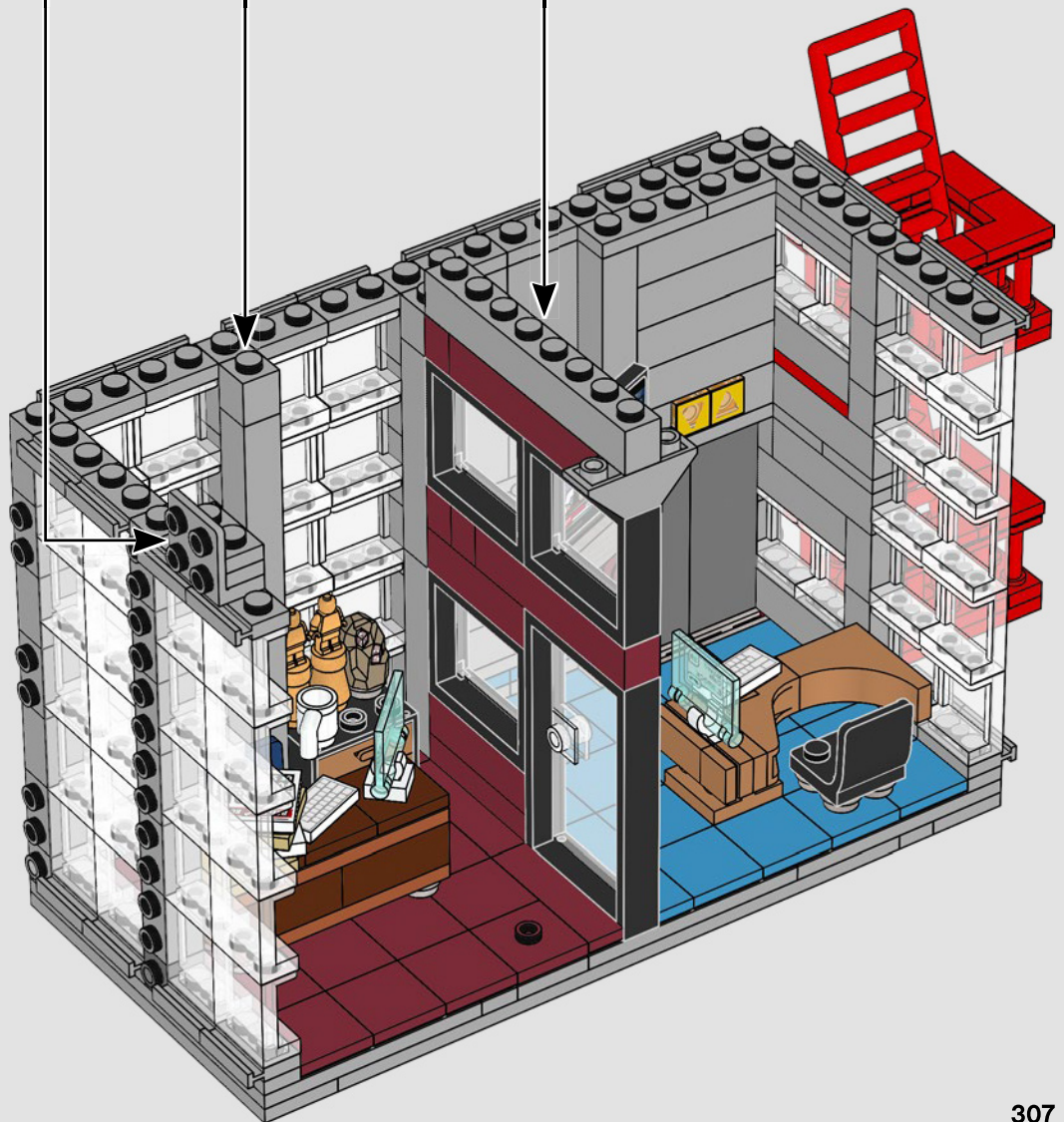
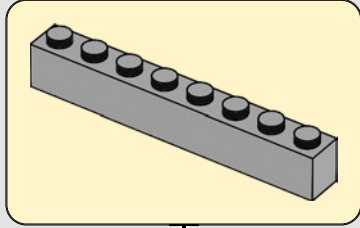
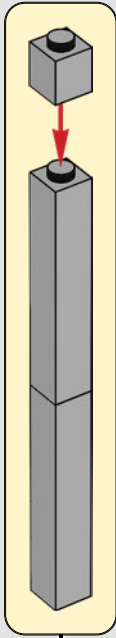
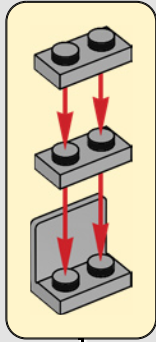



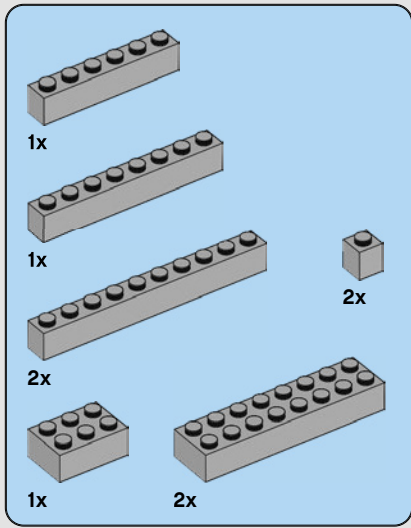

425

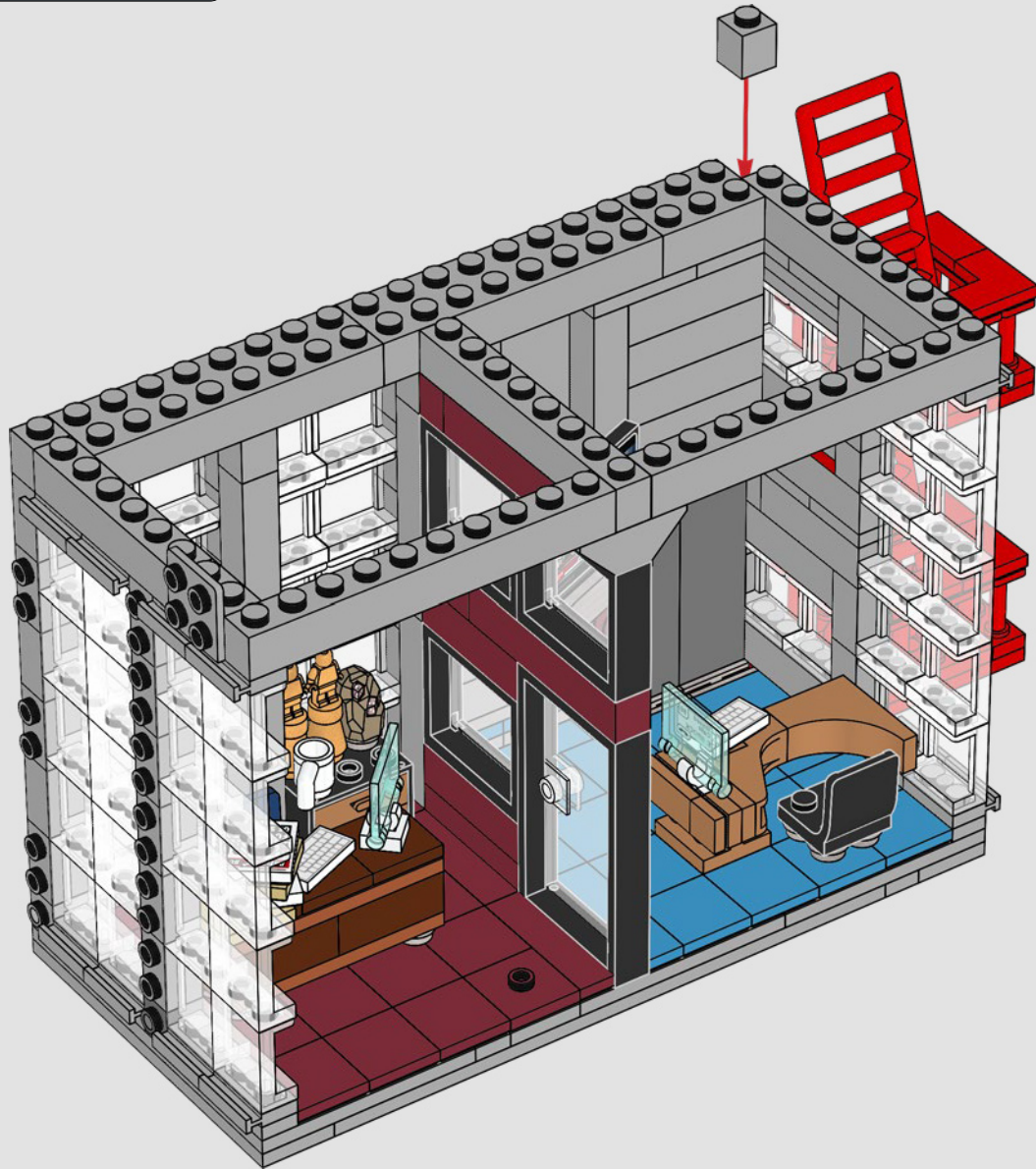

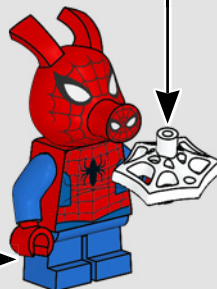
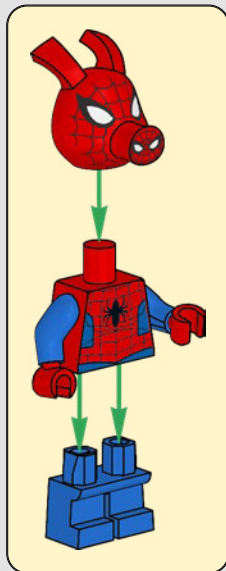
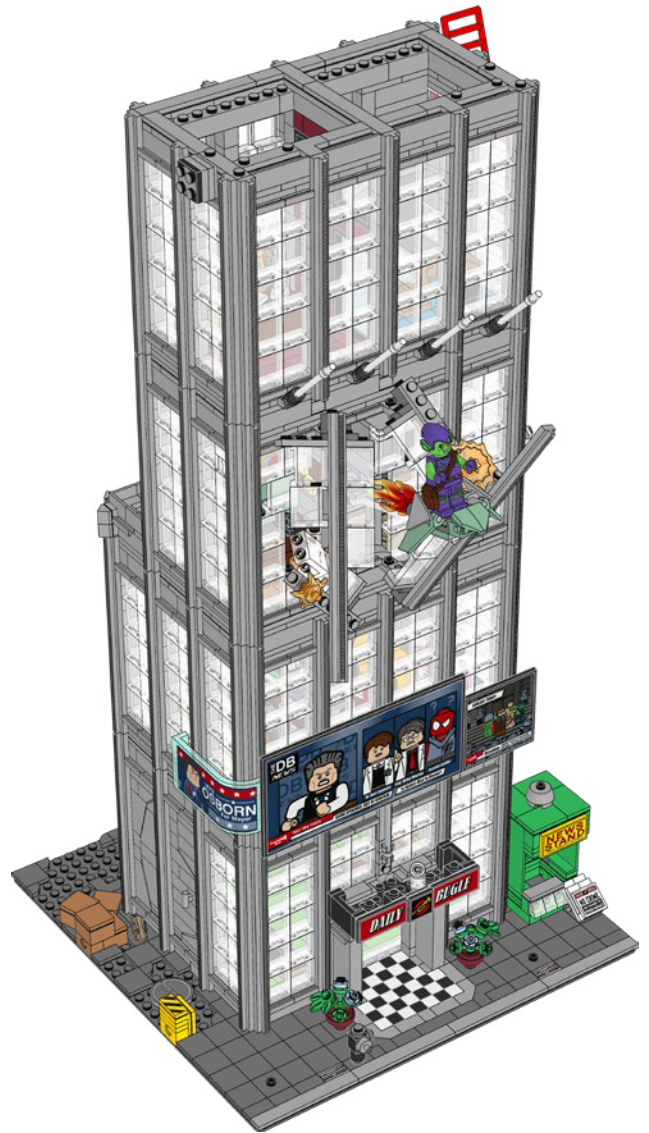
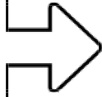

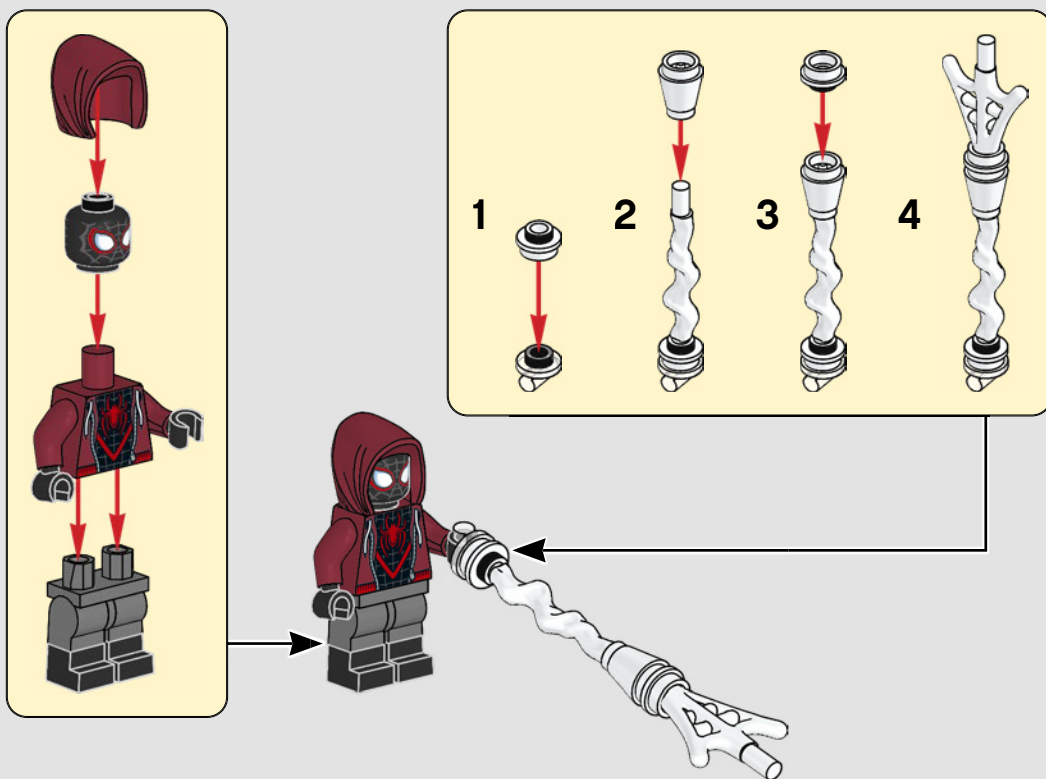
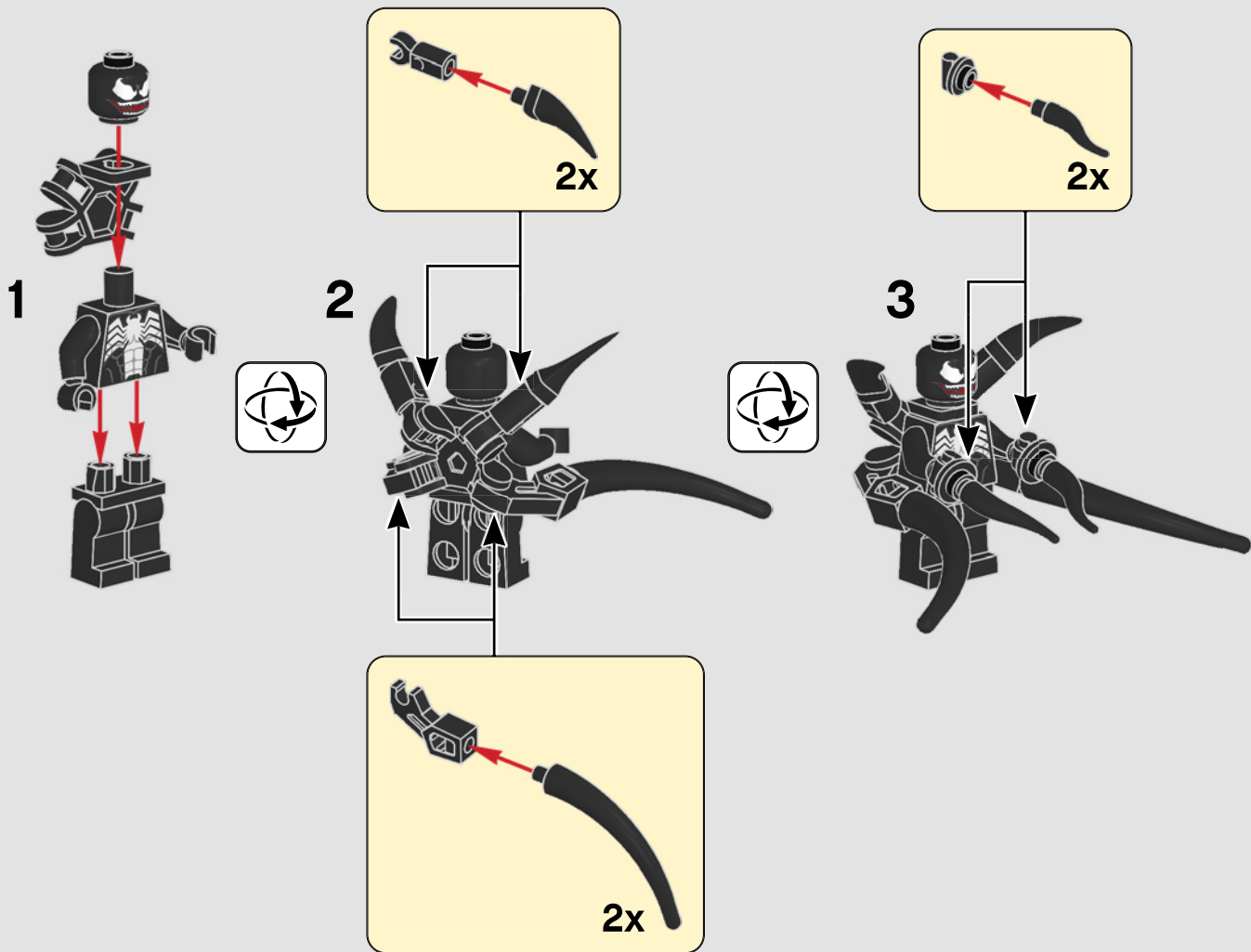



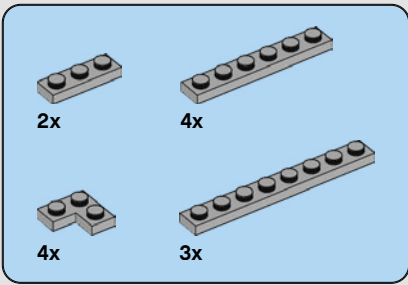

426

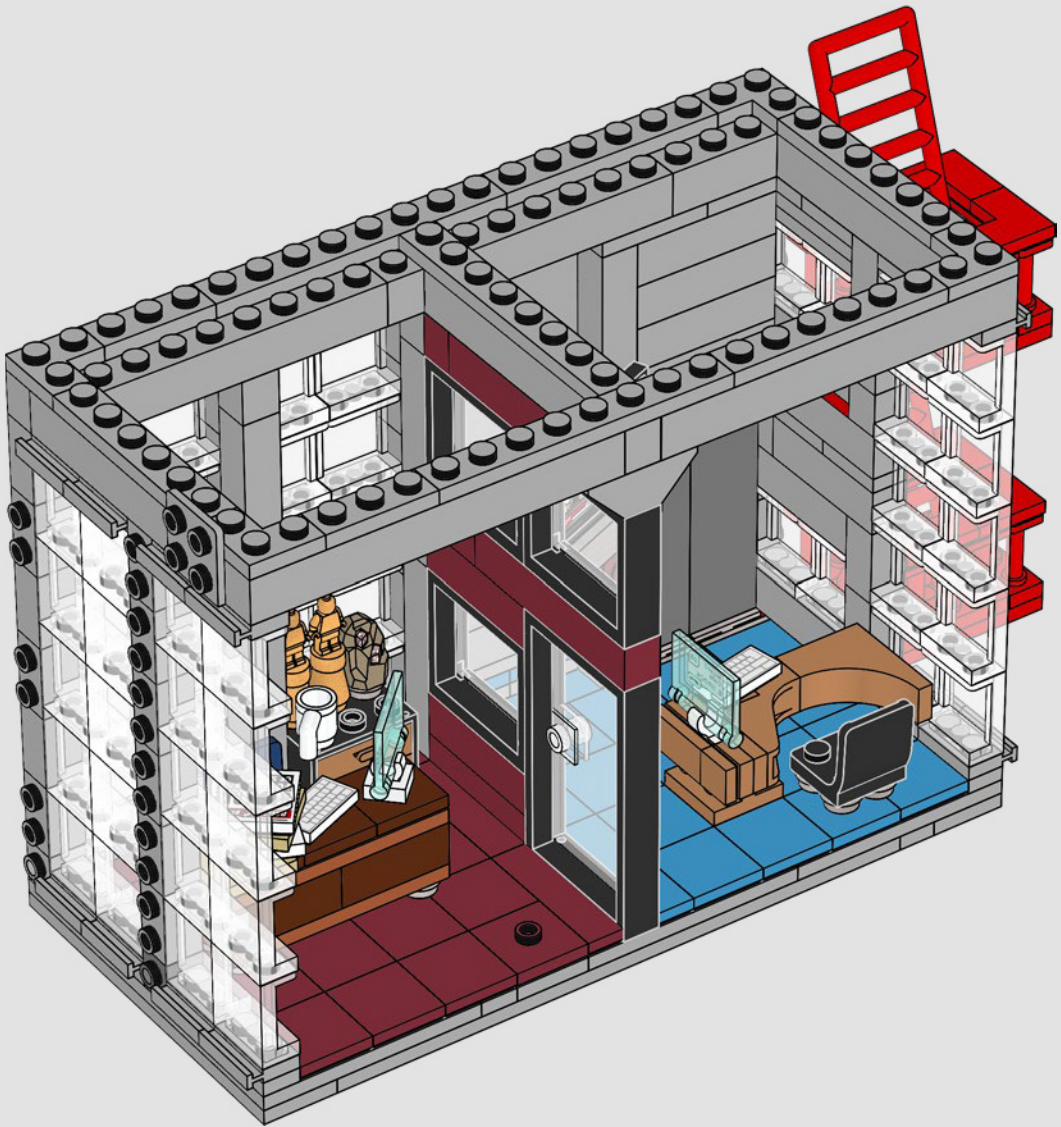

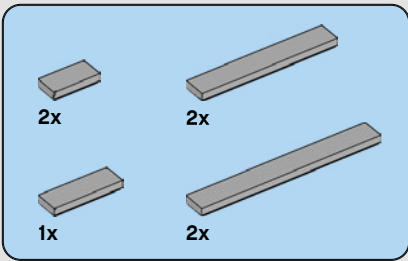

427

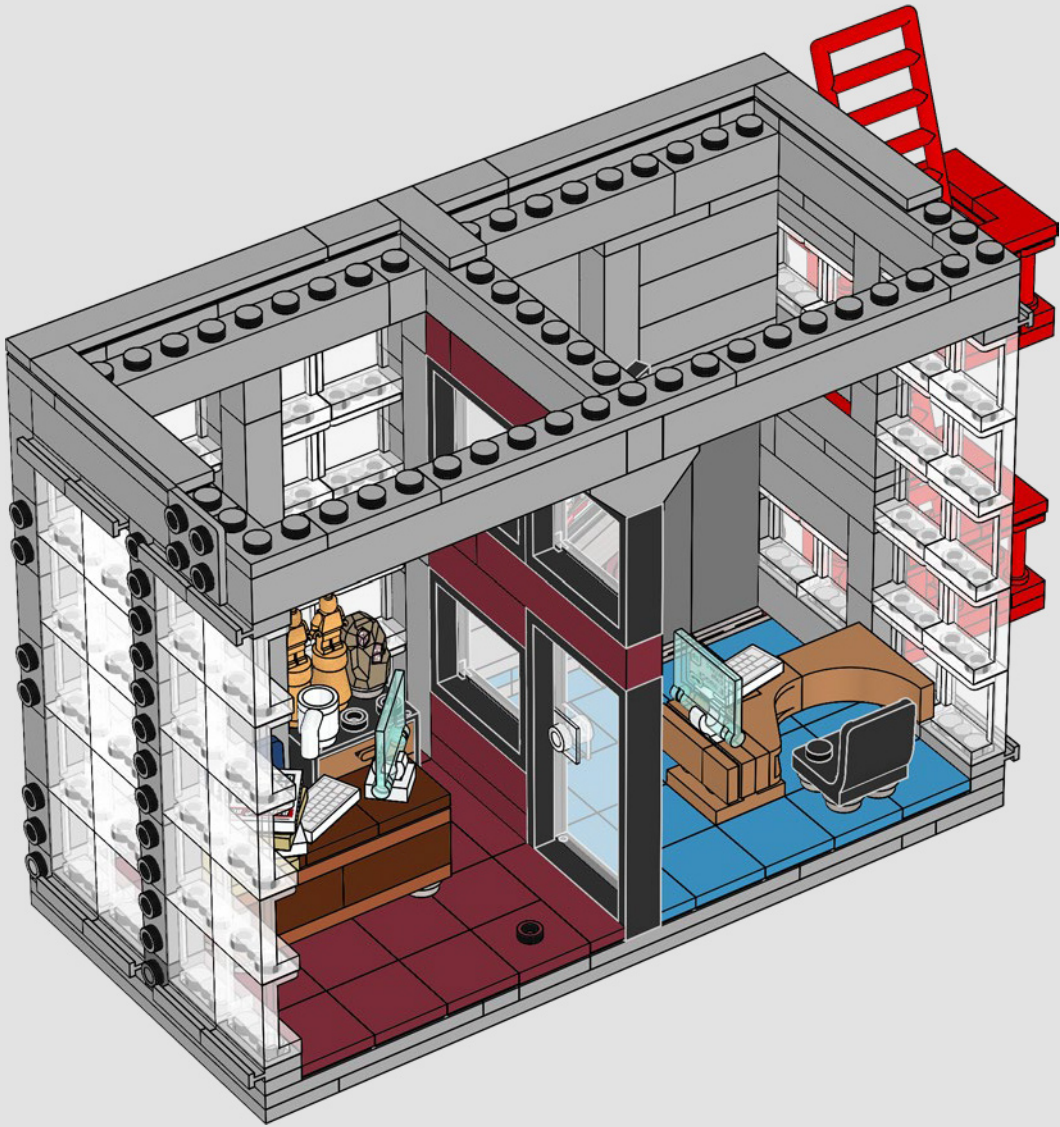

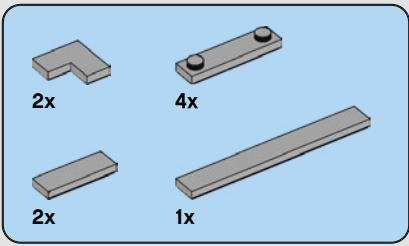

428

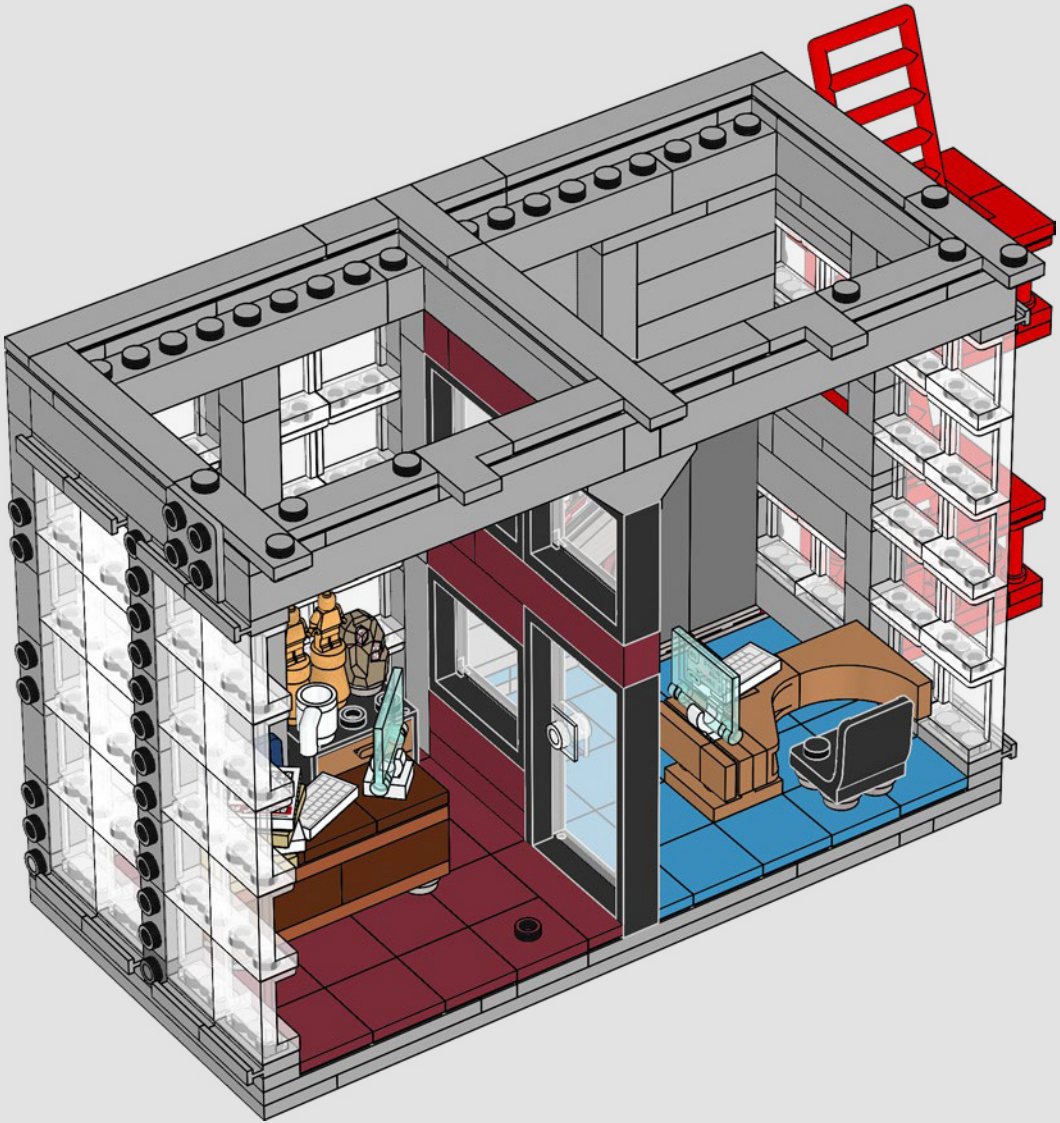



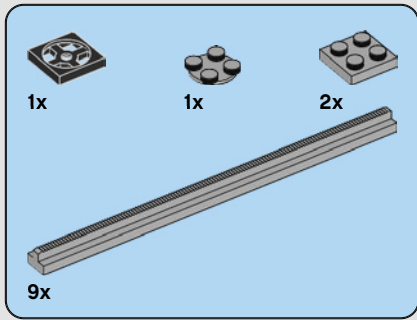

429

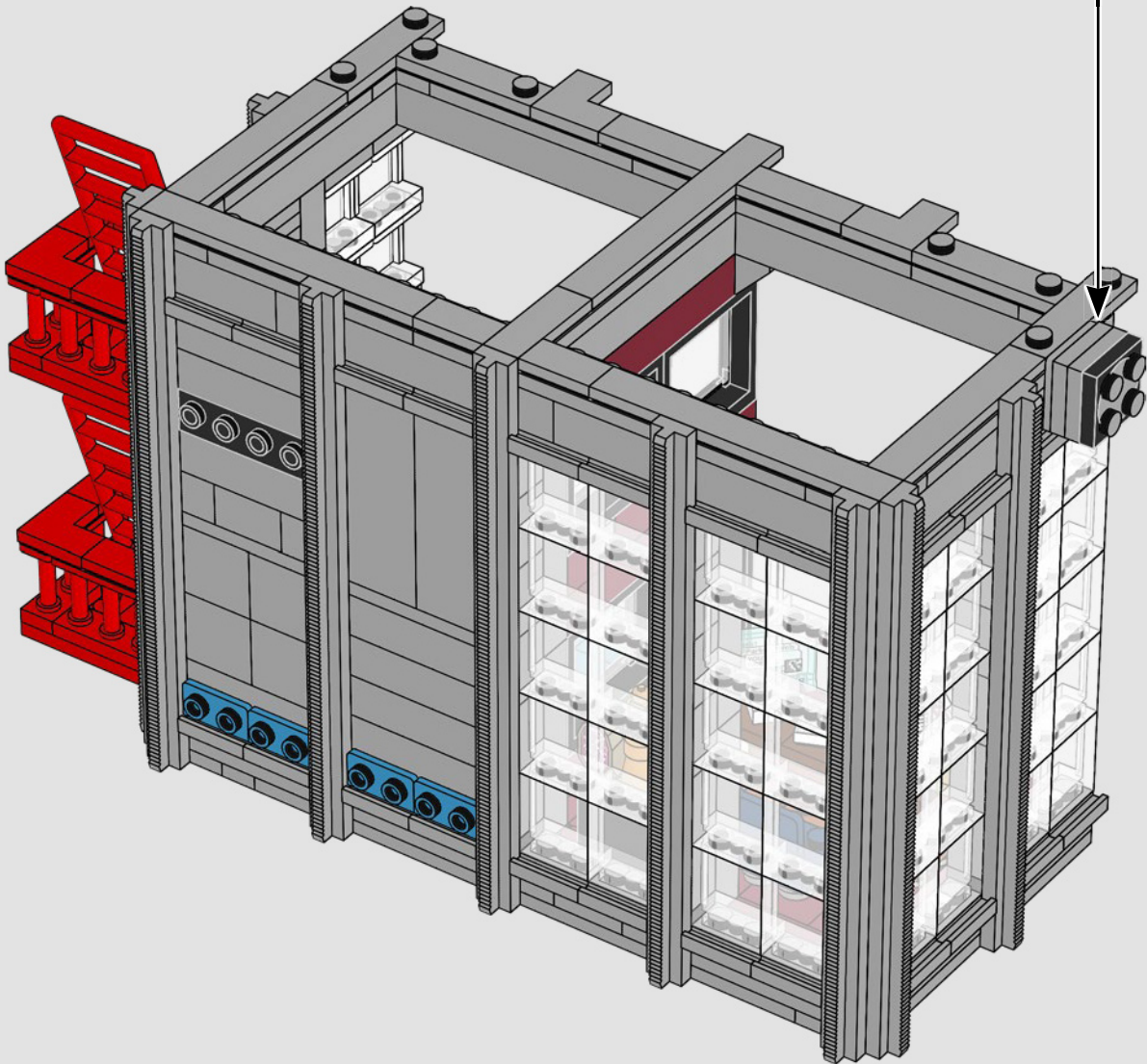
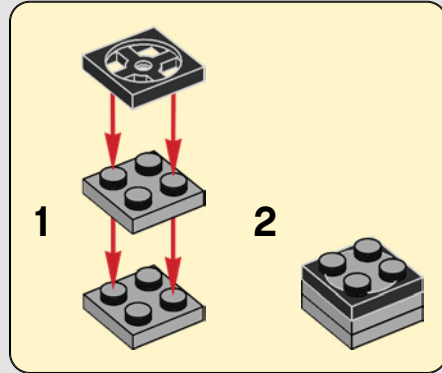

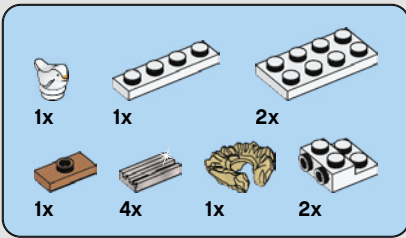

430

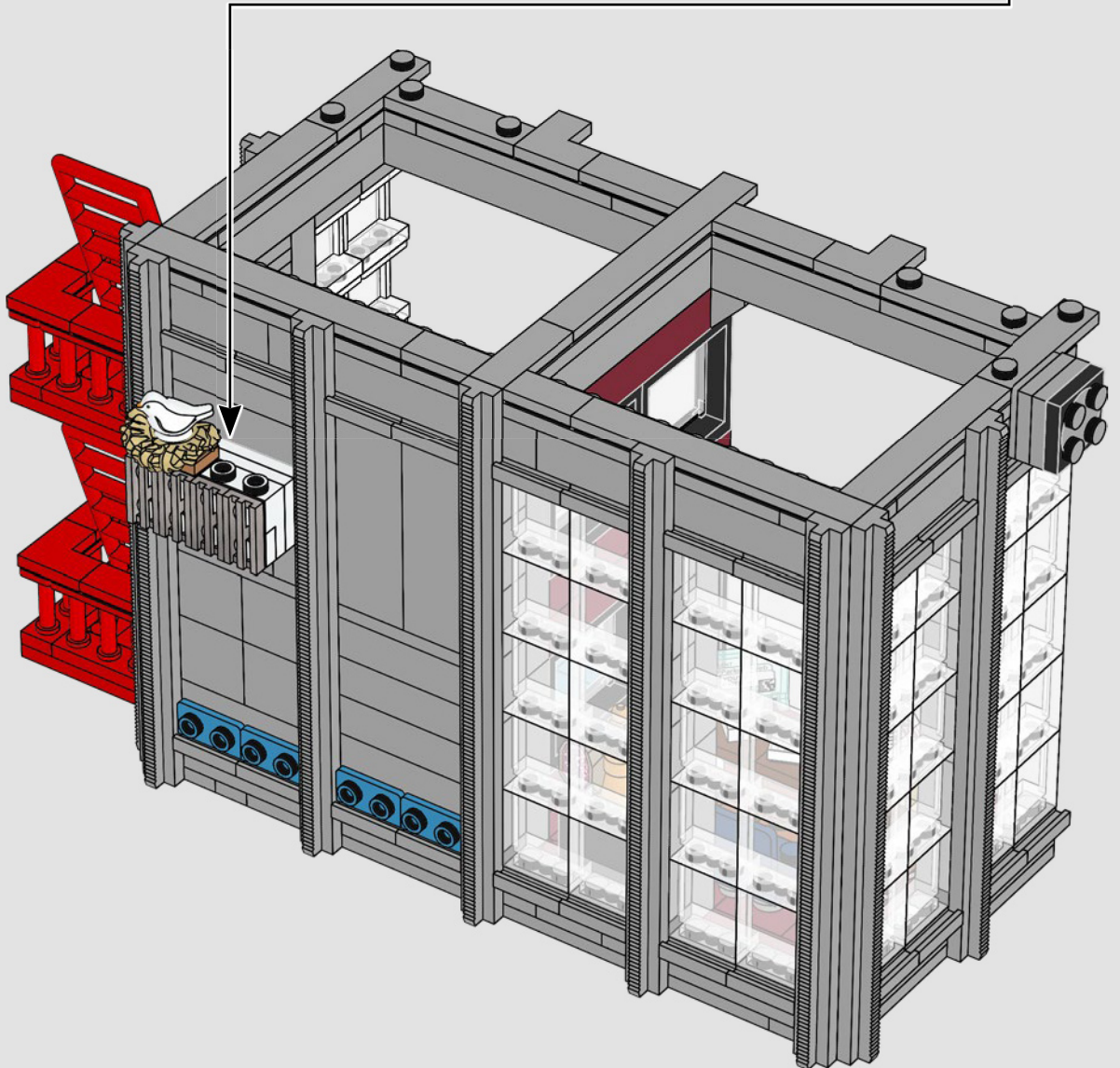
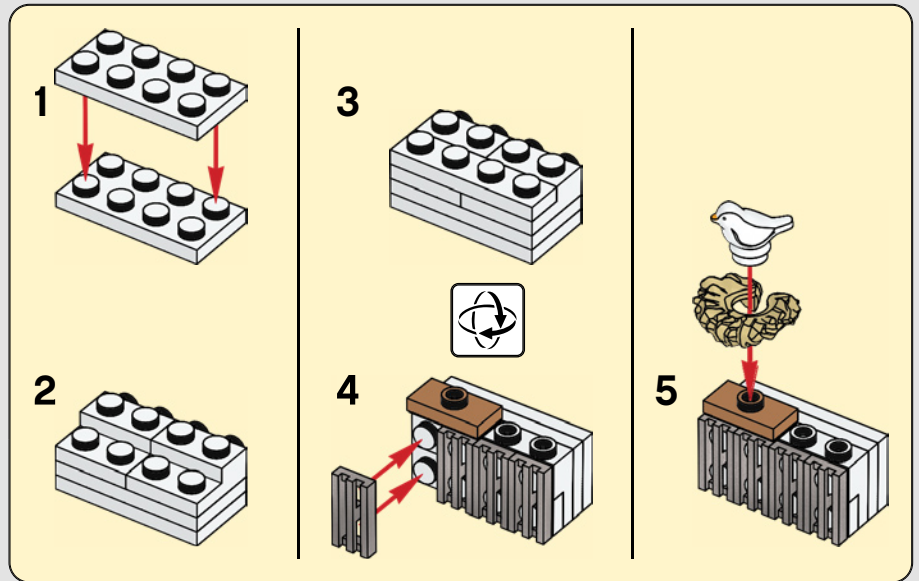

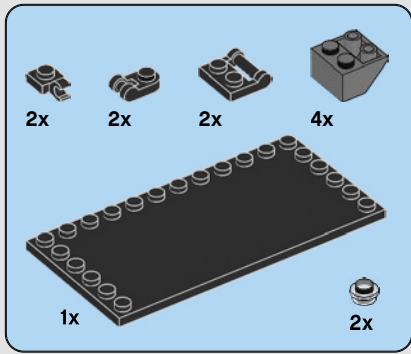

# 431

1

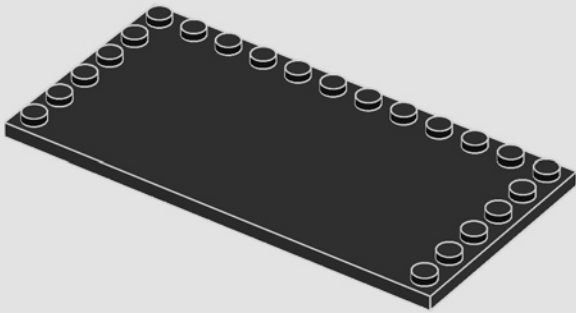

2

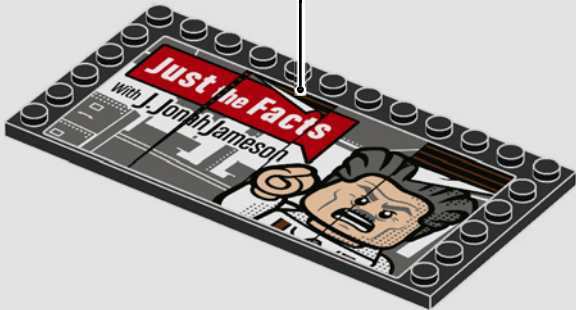

3

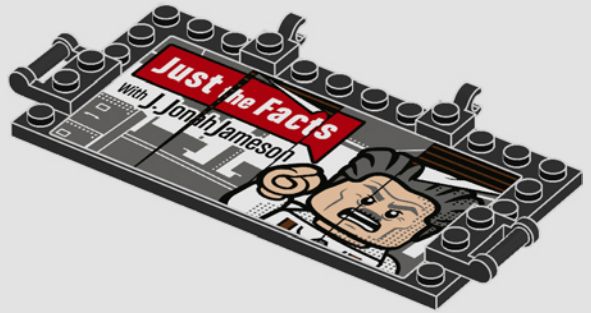

4

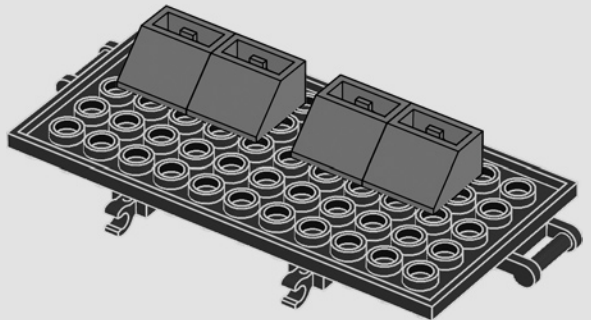
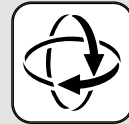



5

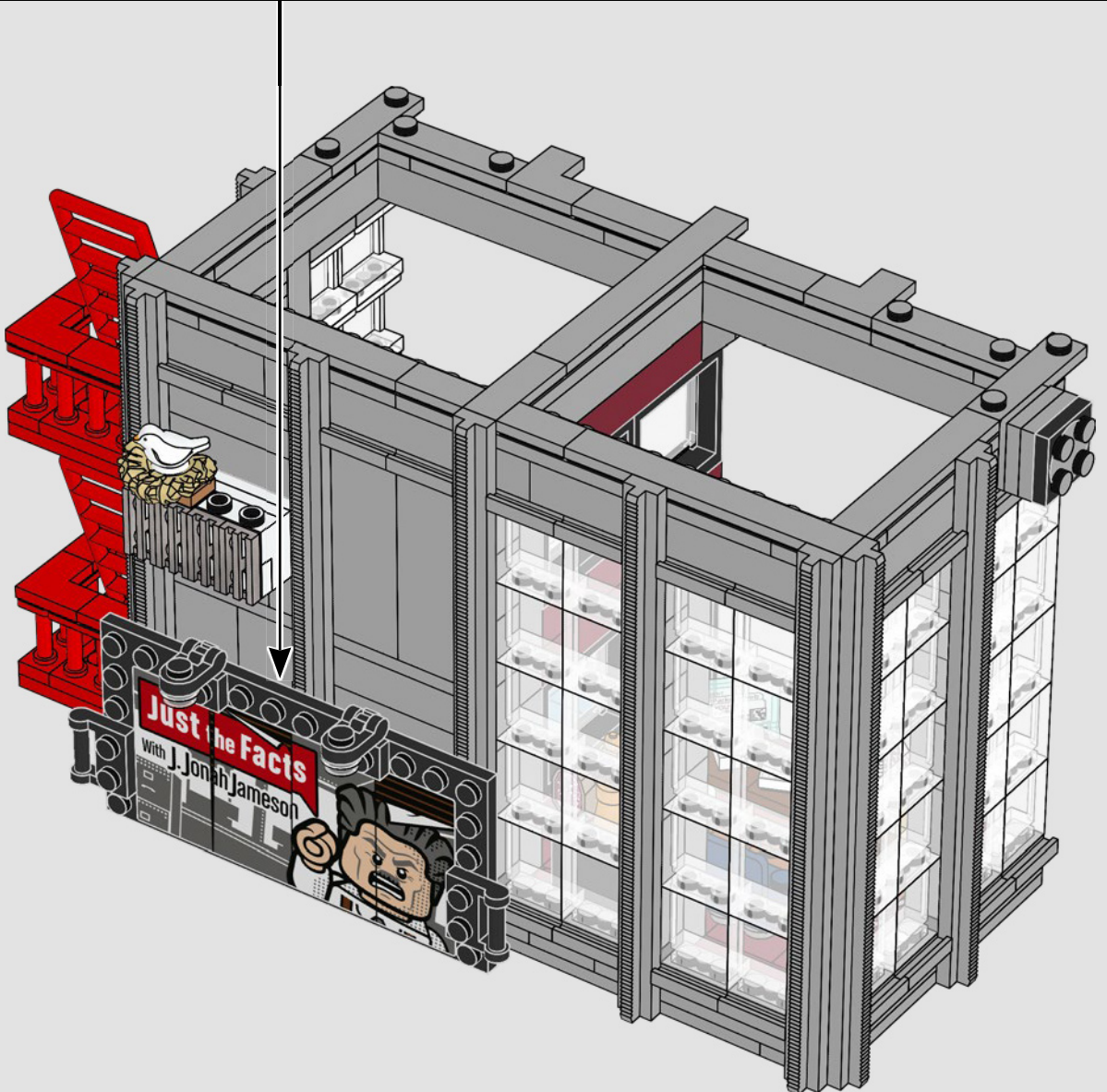
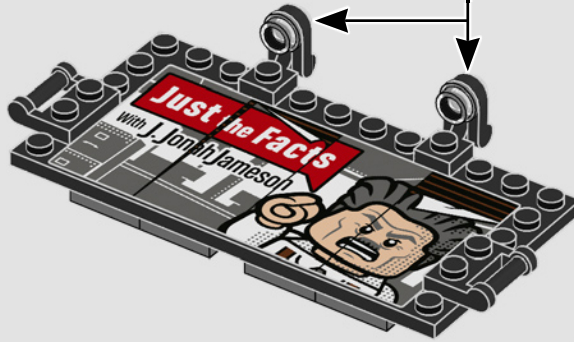
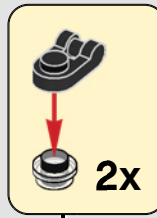



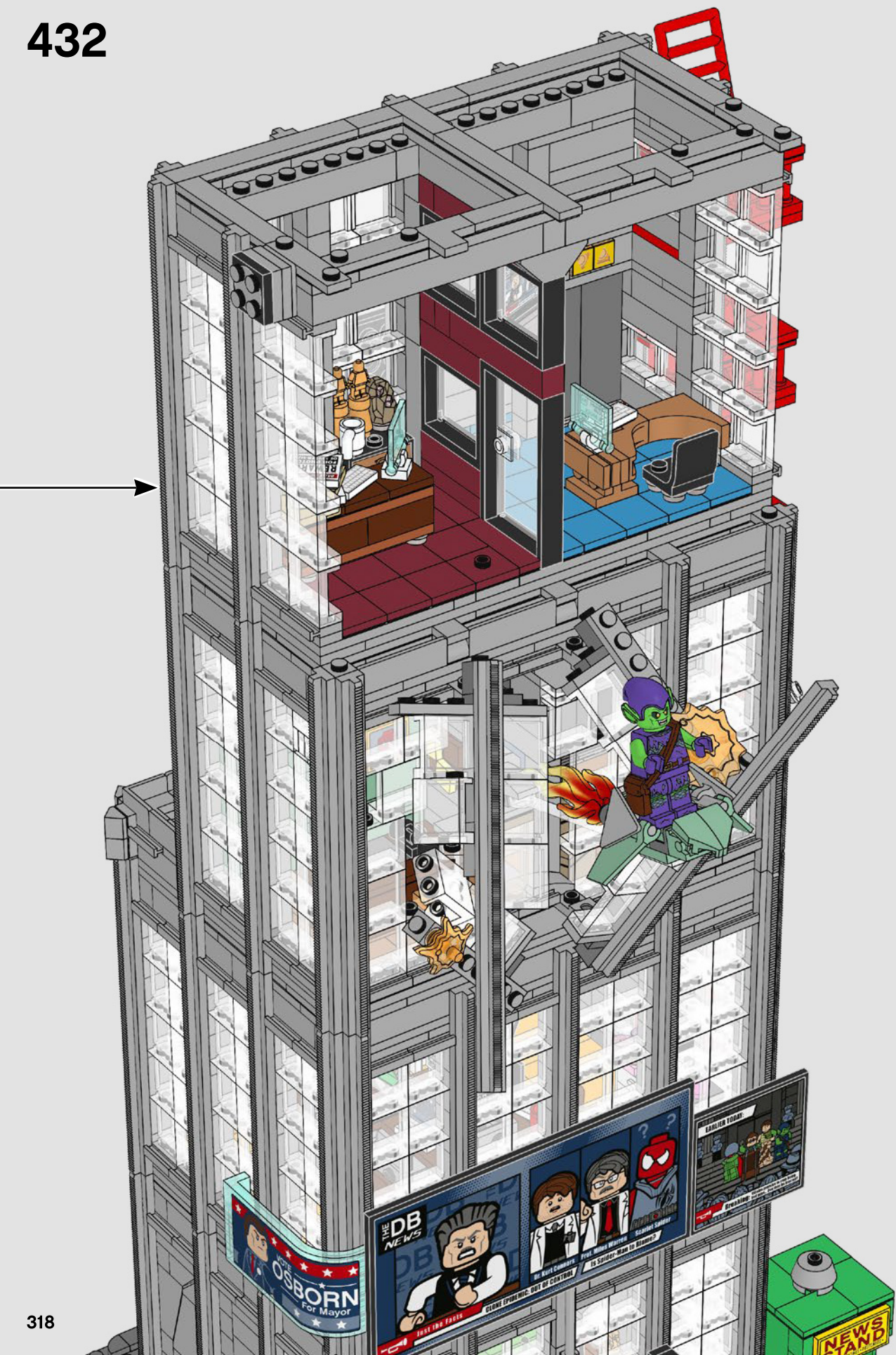

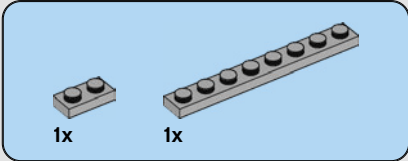
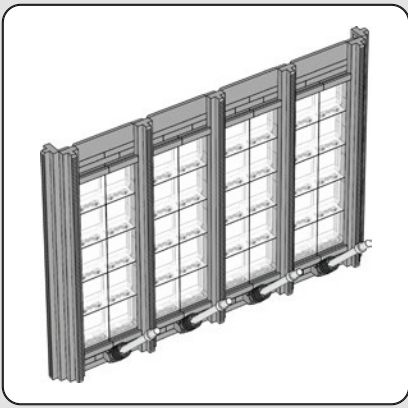

433

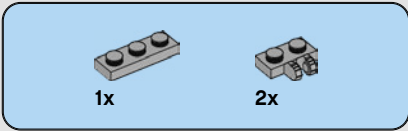
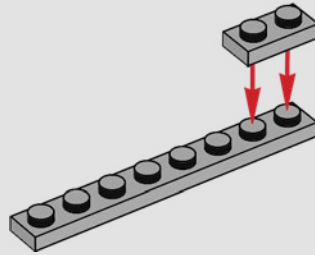

434

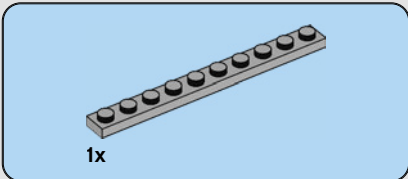
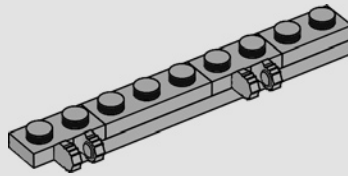

435

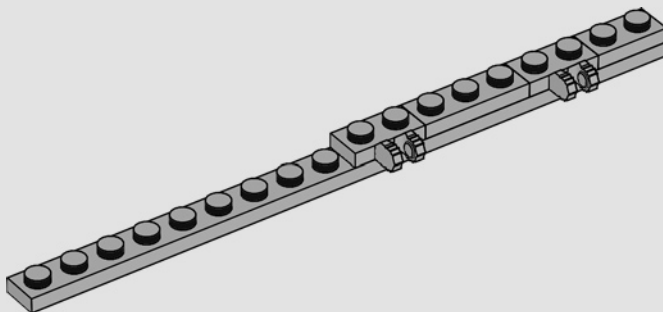



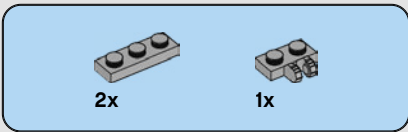

# 436

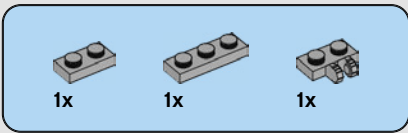
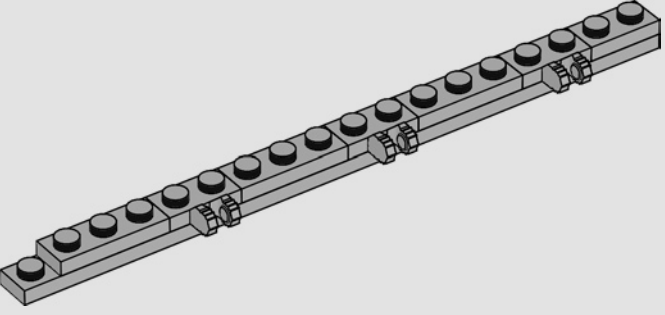

# 437

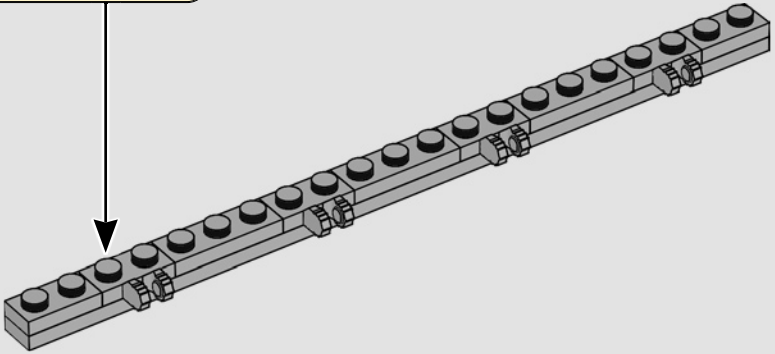
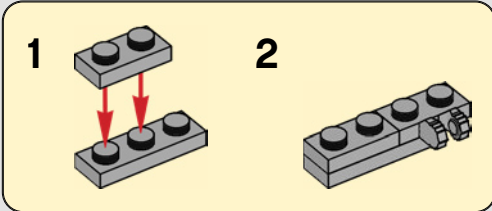

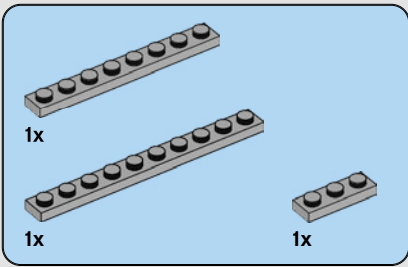

438

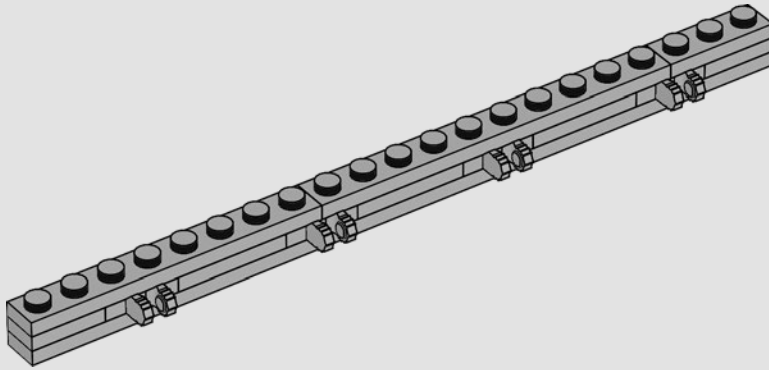

439

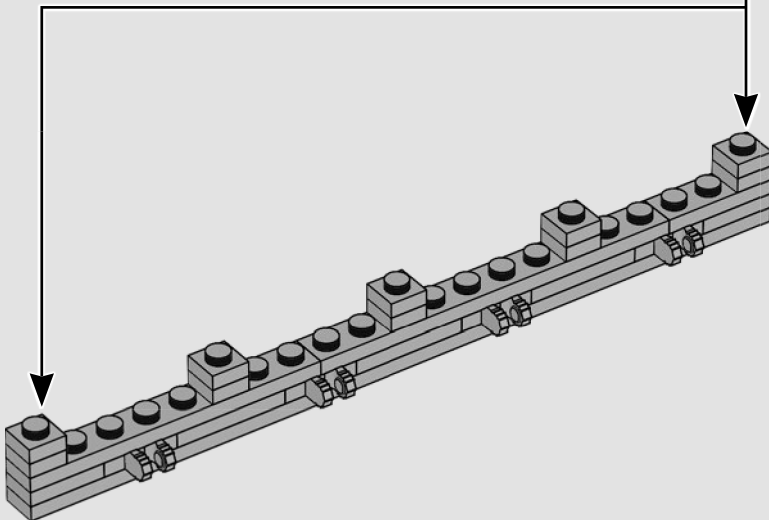
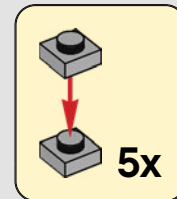



12x

440

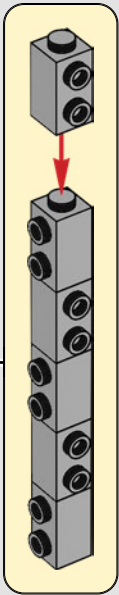
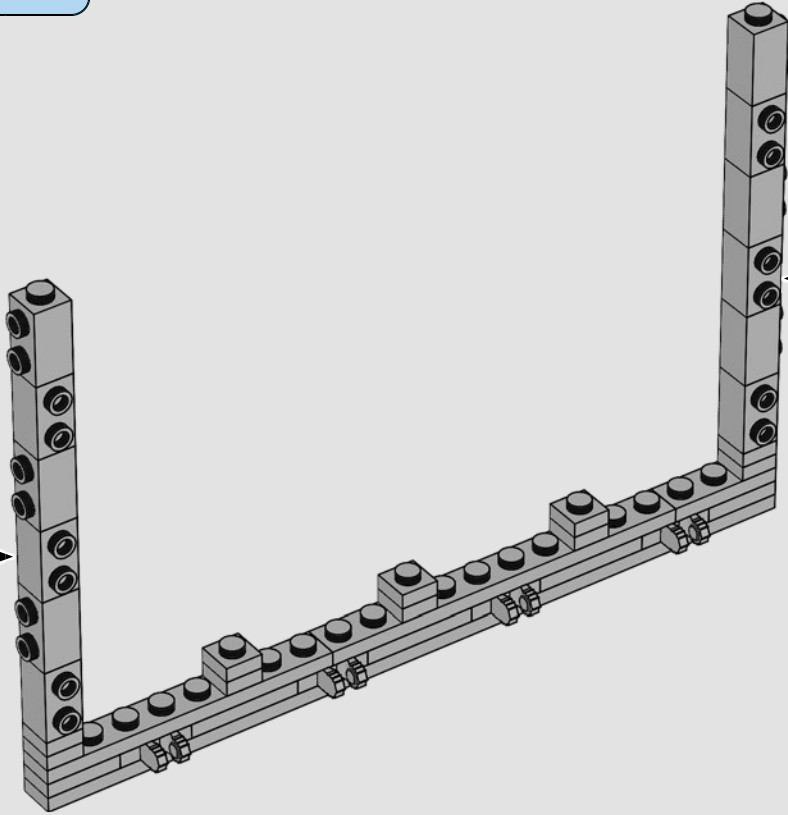
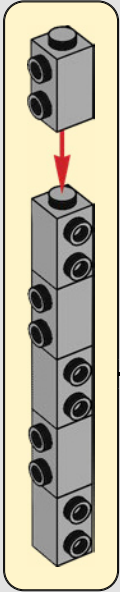

18x

441

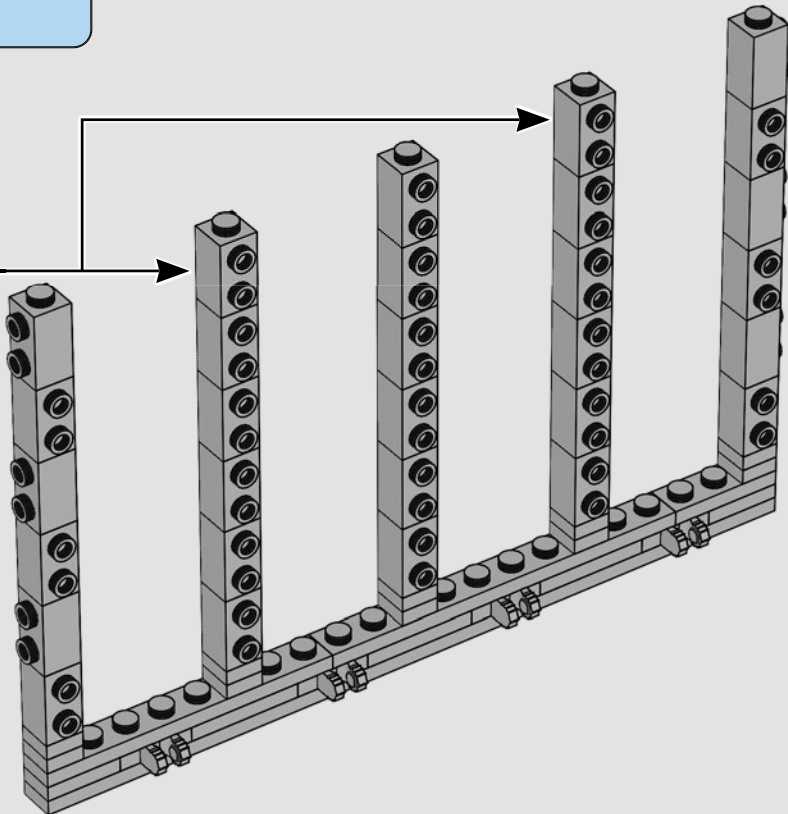
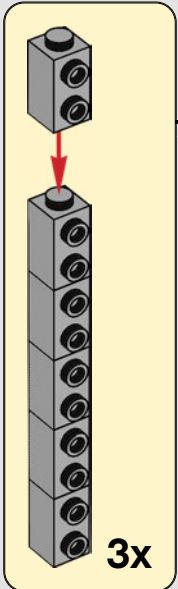



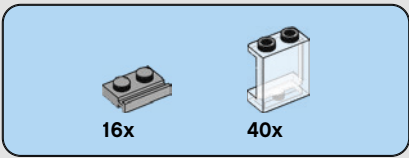

# 442

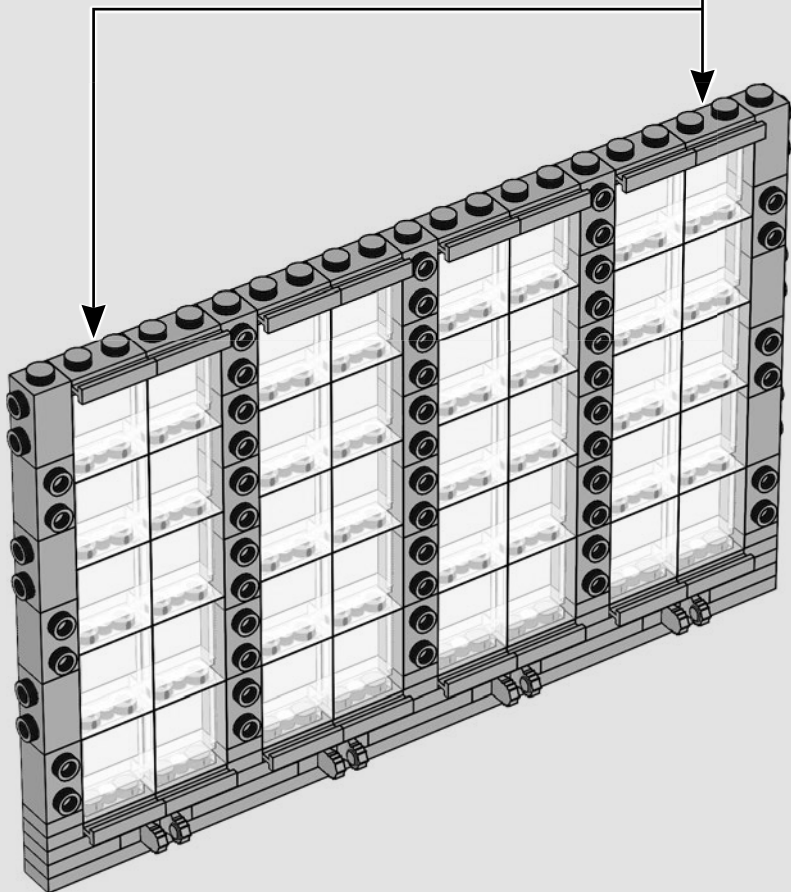
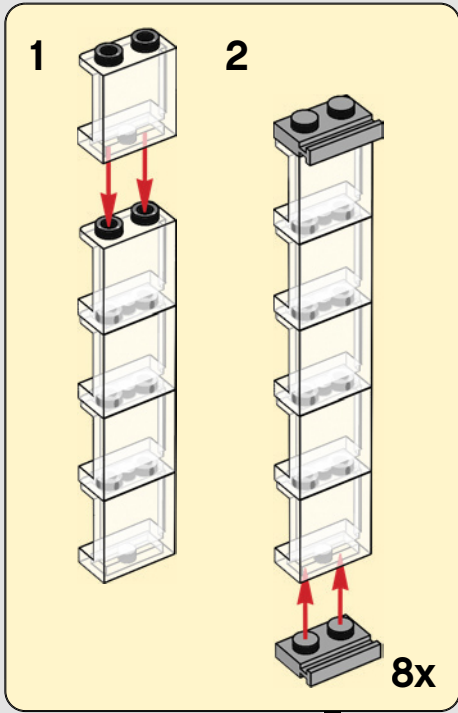

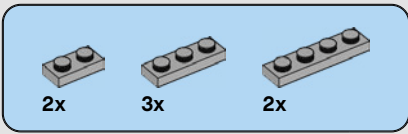

# 443

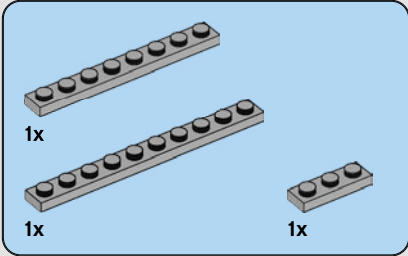
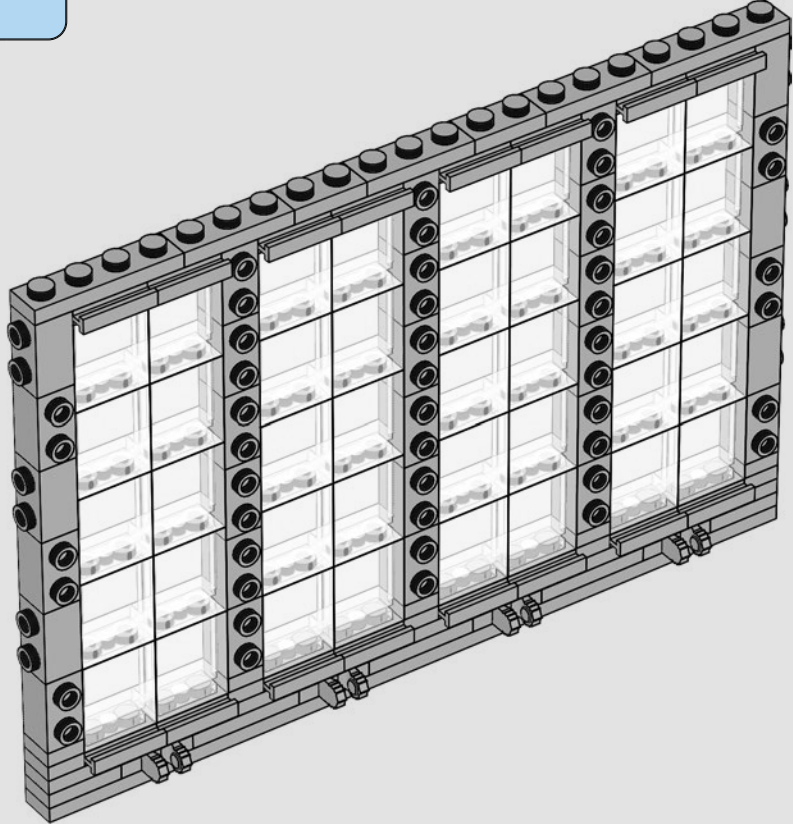

# 444

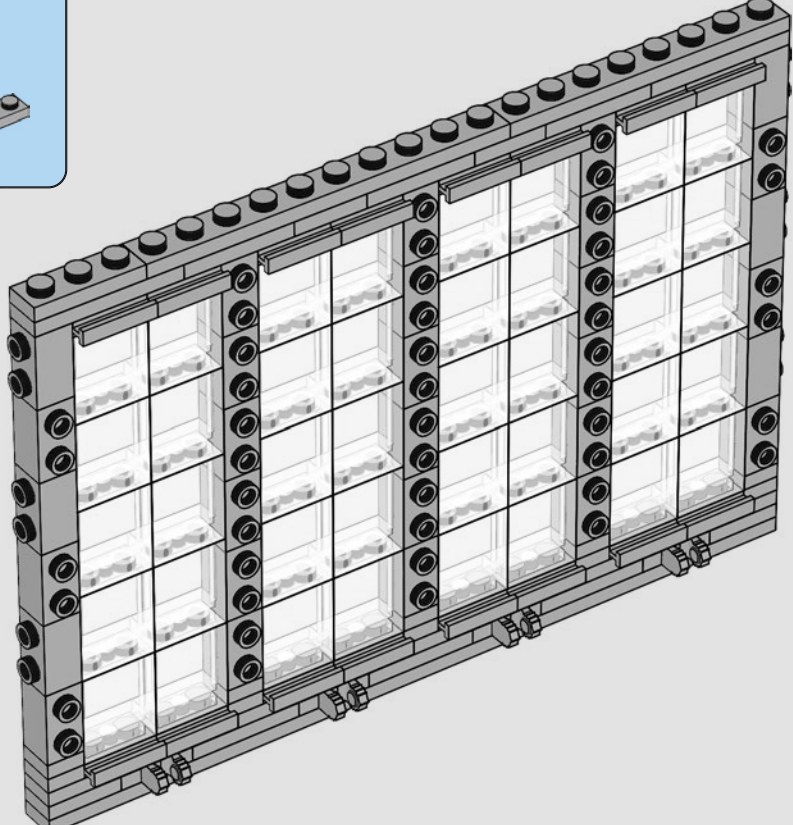

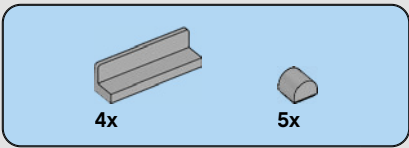

**445**

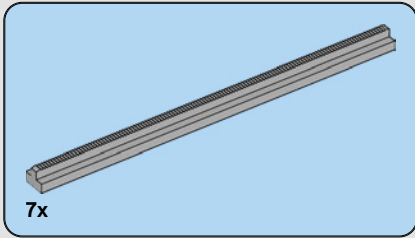
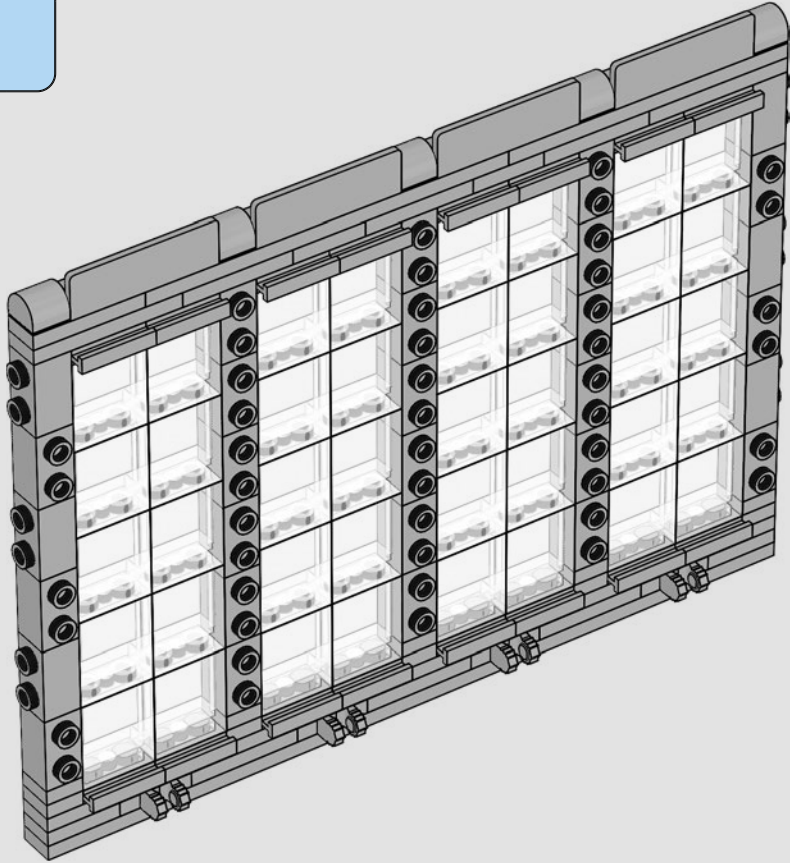

**446**

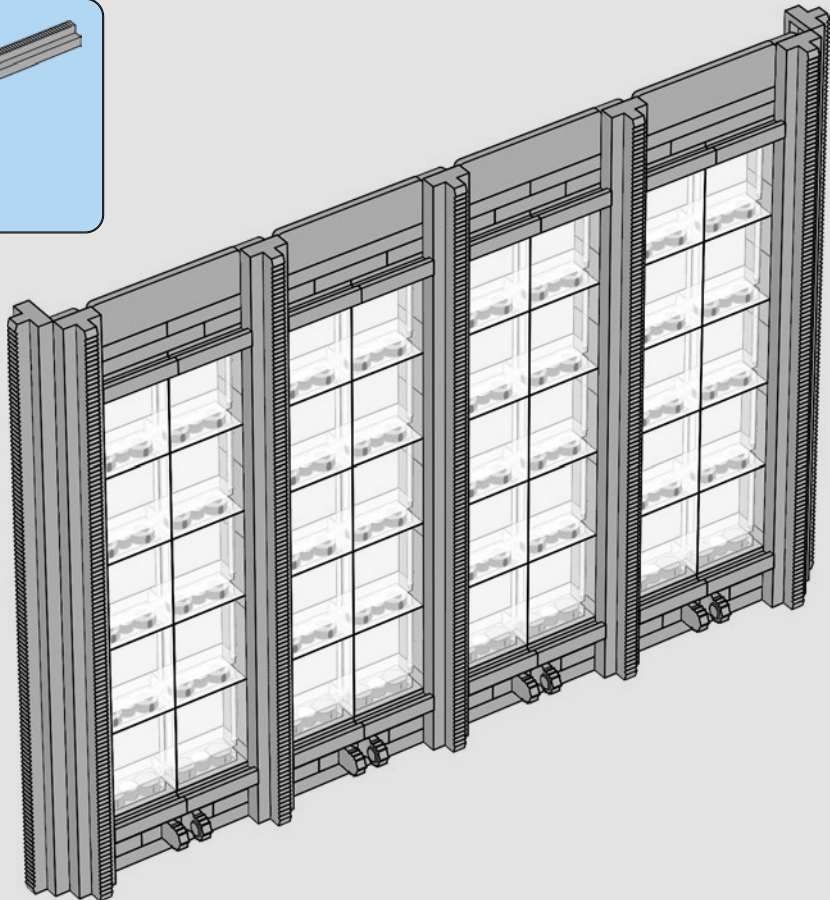



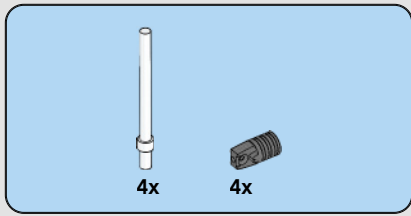

447

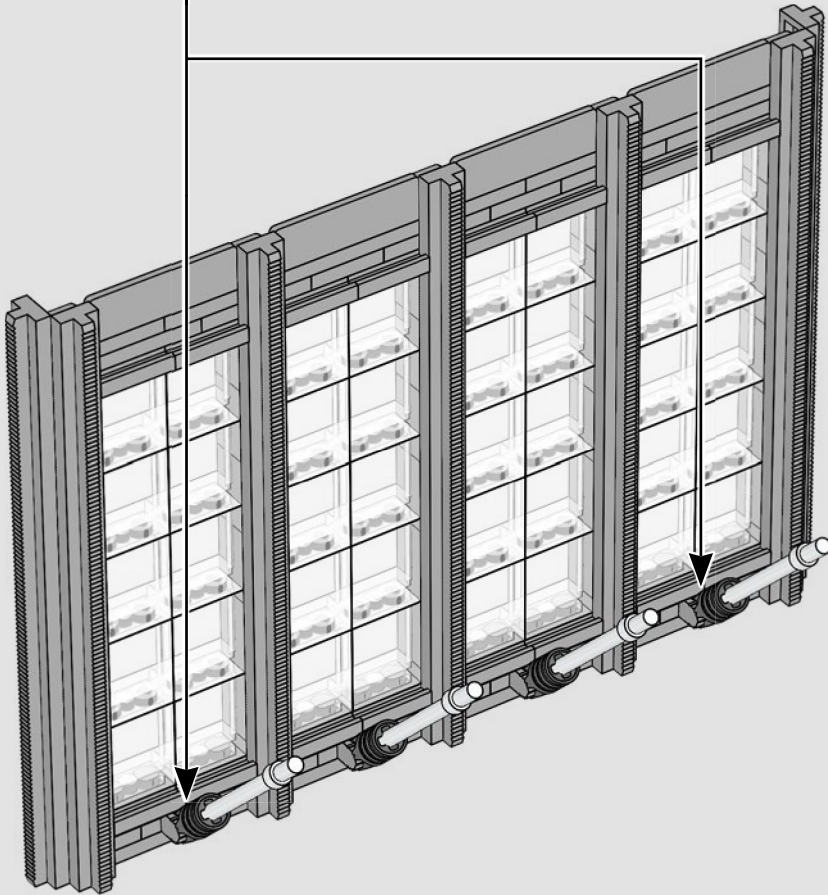
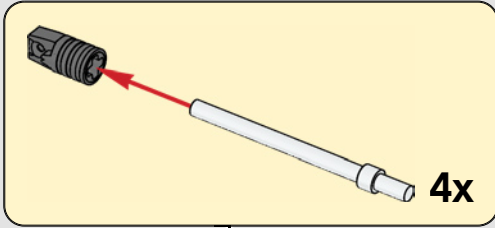

448

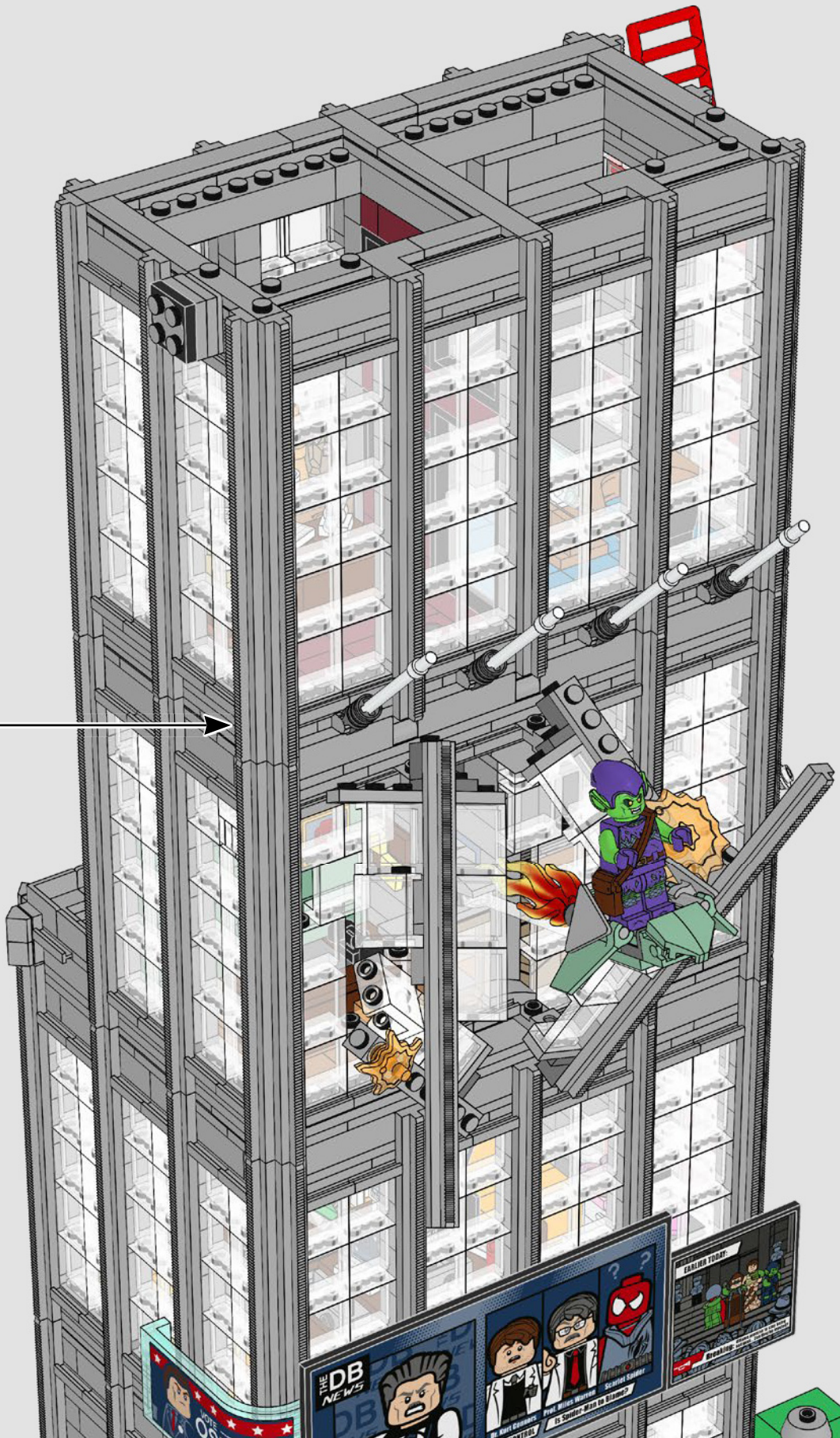

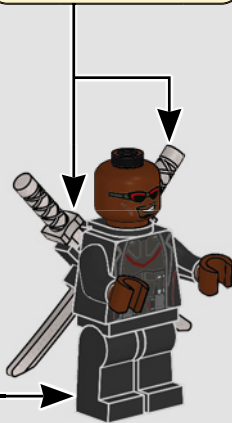
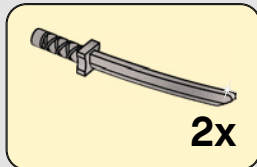
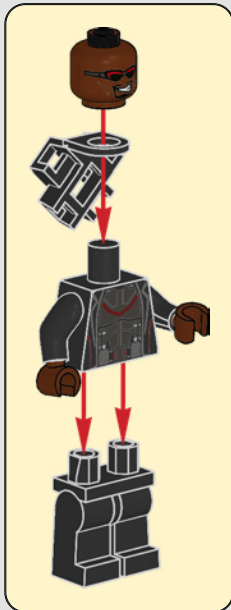
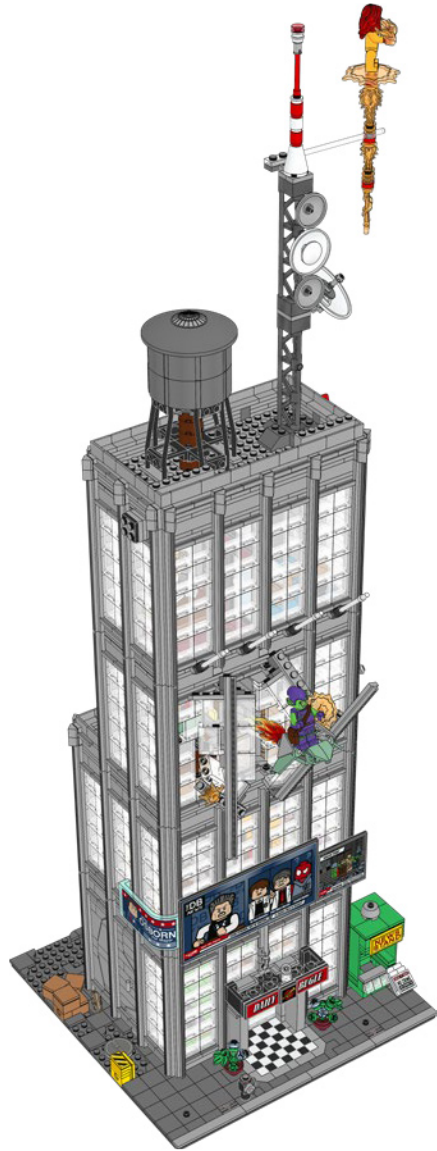



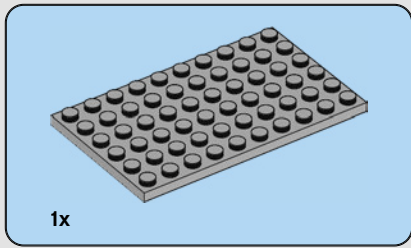
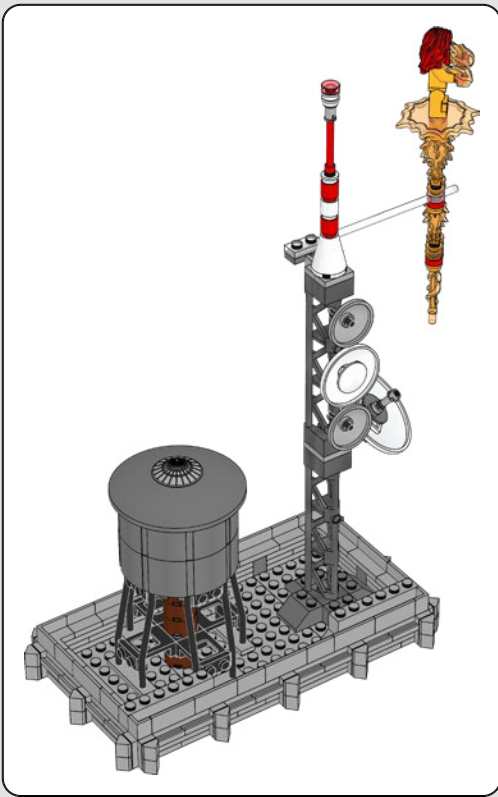

450

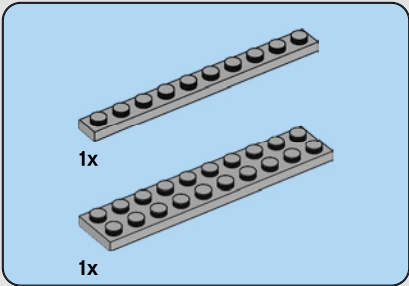

449

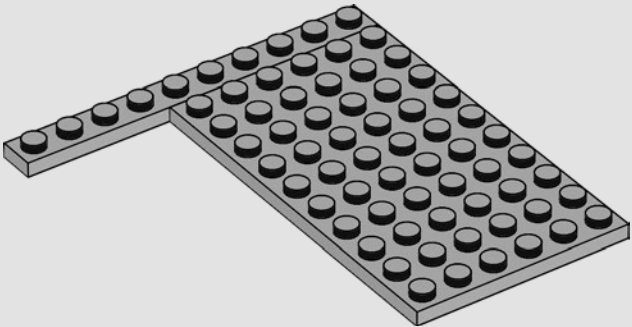
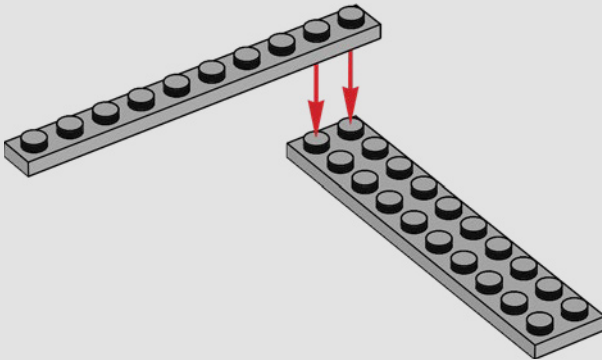

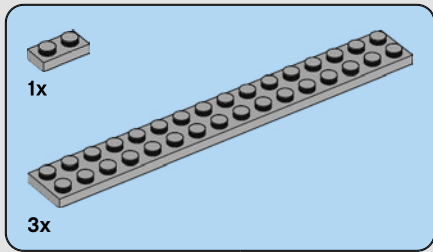

451

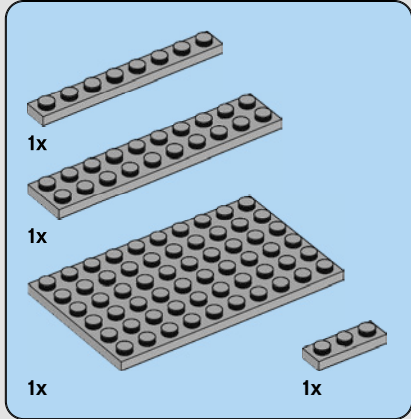
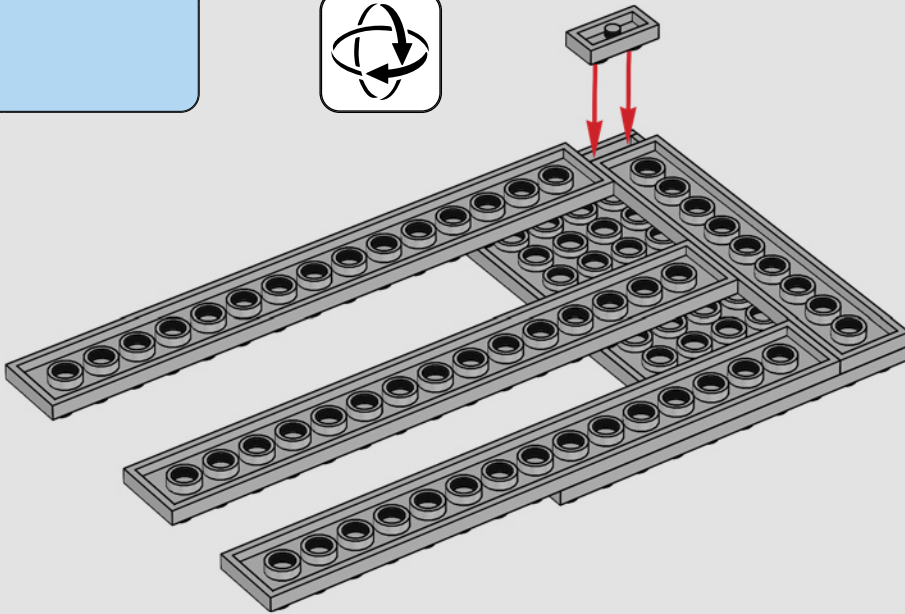

452

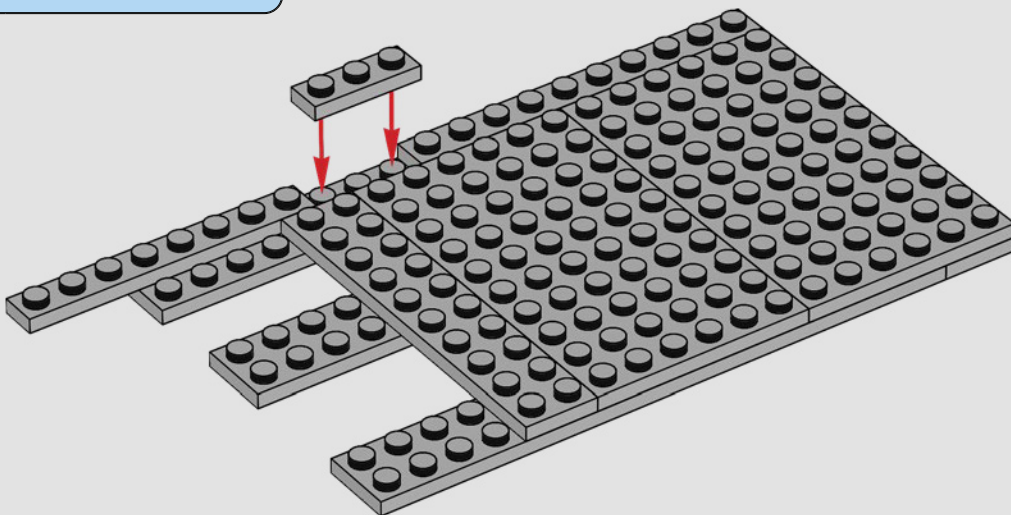
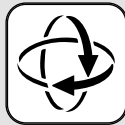

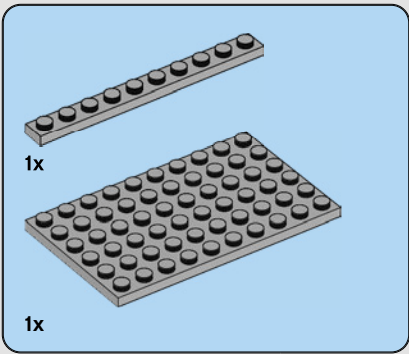

**453**

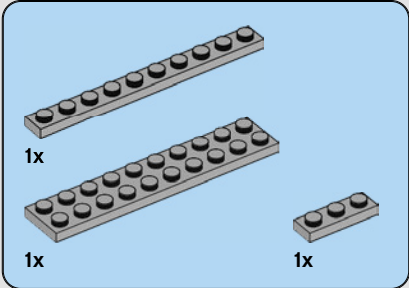
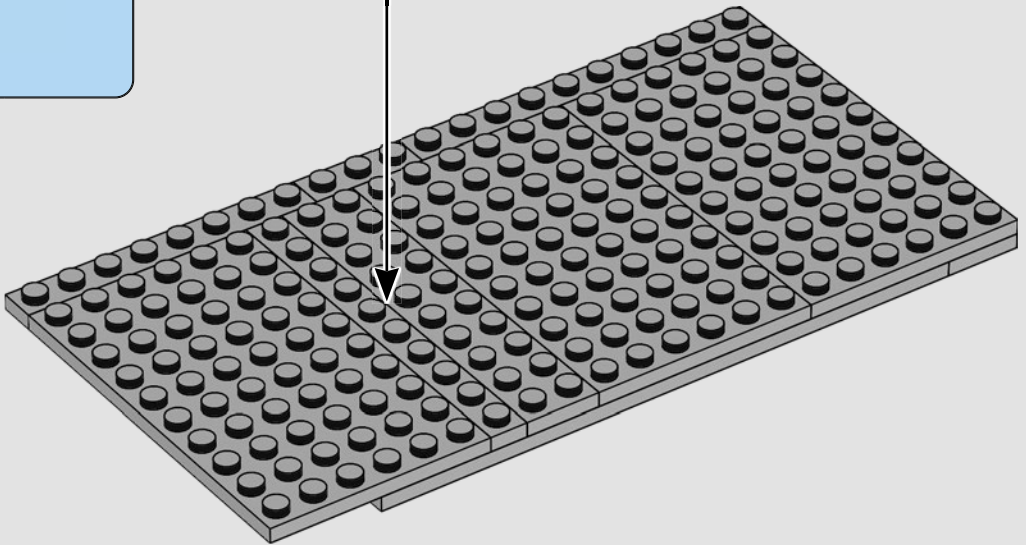
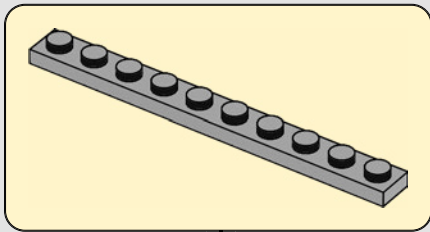

**454**

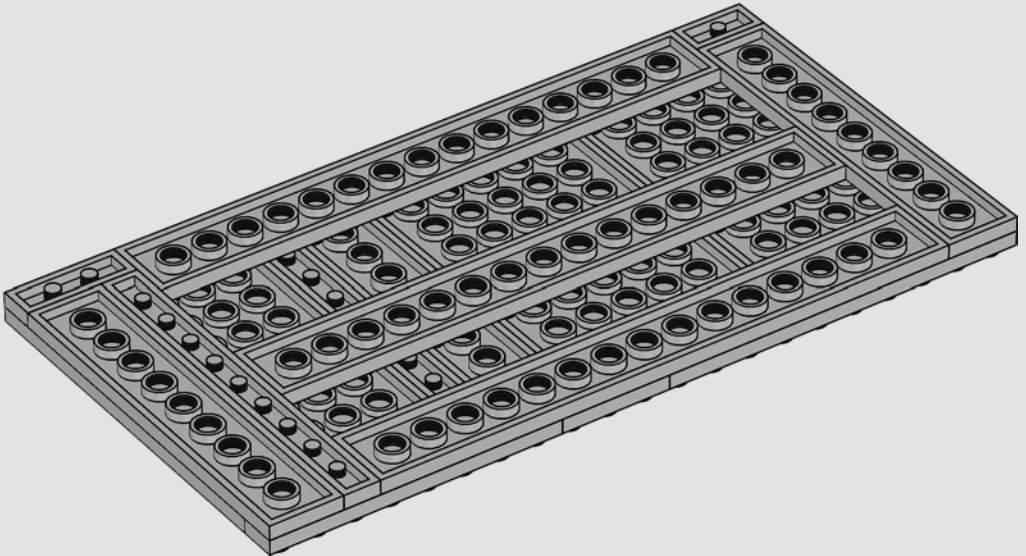





12x

455

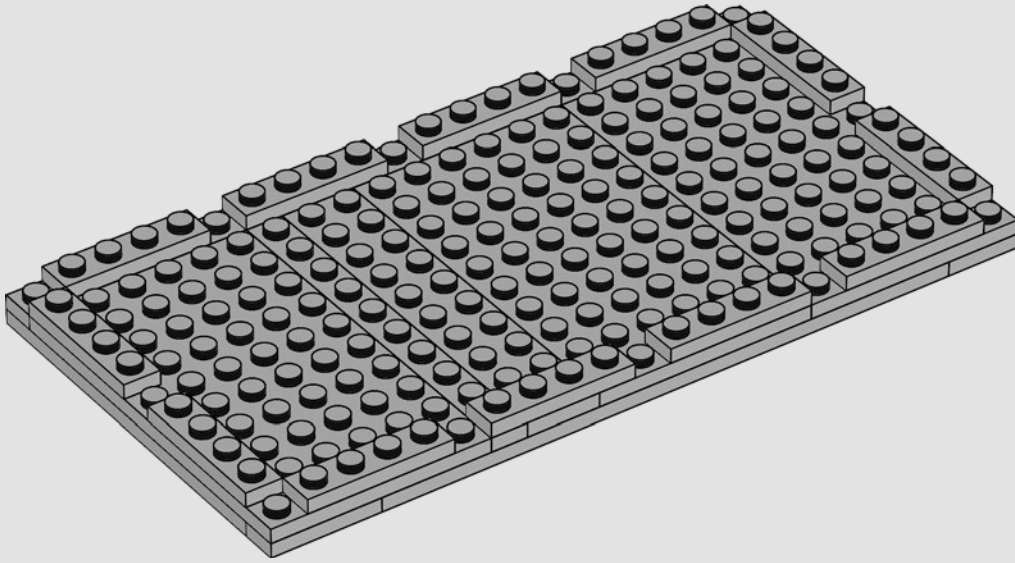

3x

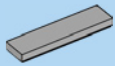

4x



1x

456

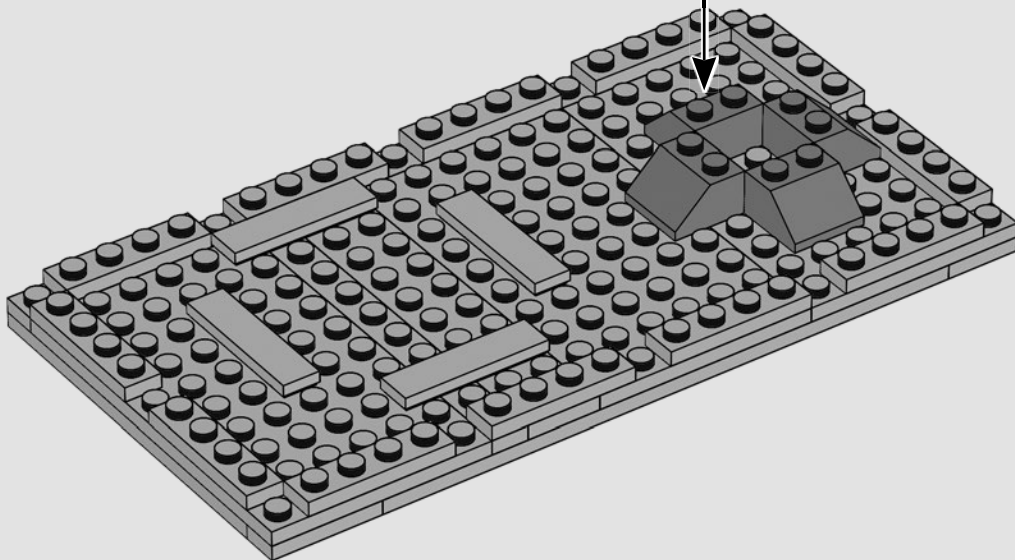
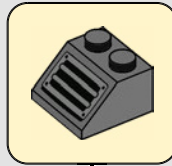

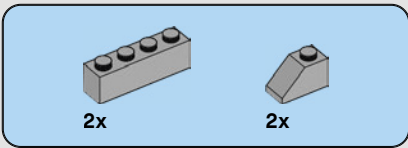

457

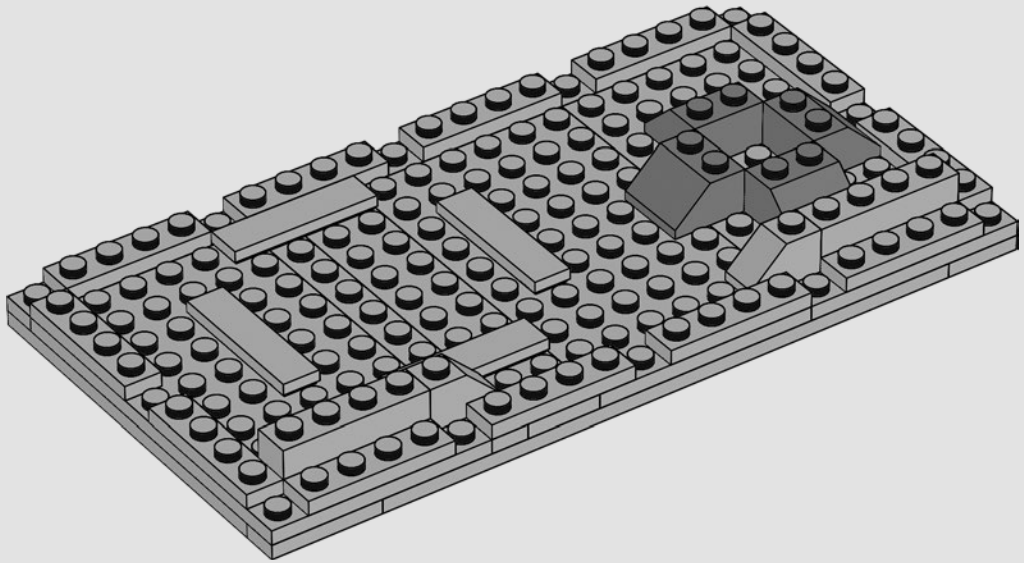

458

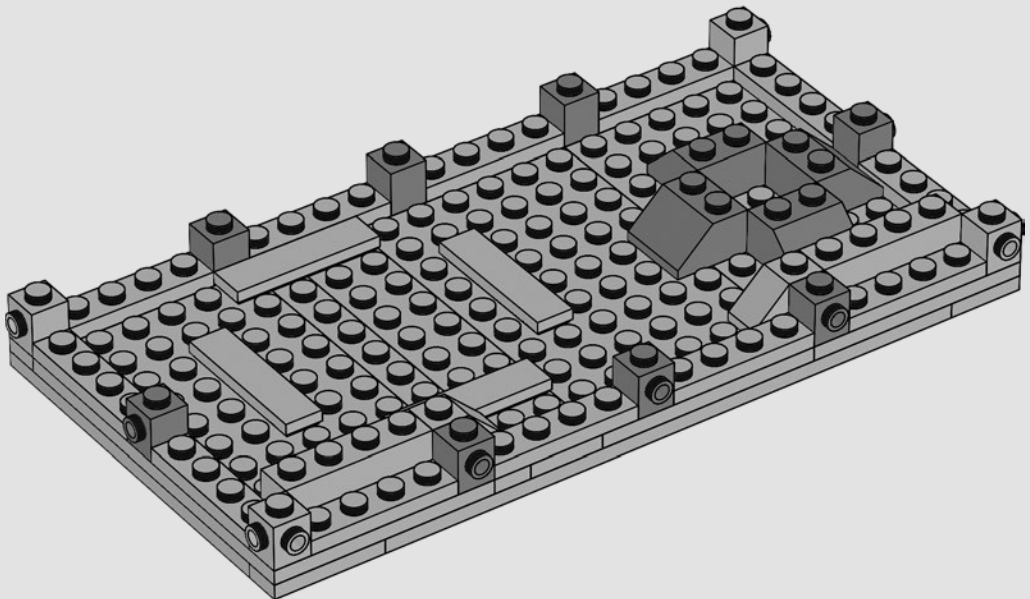



24x

459

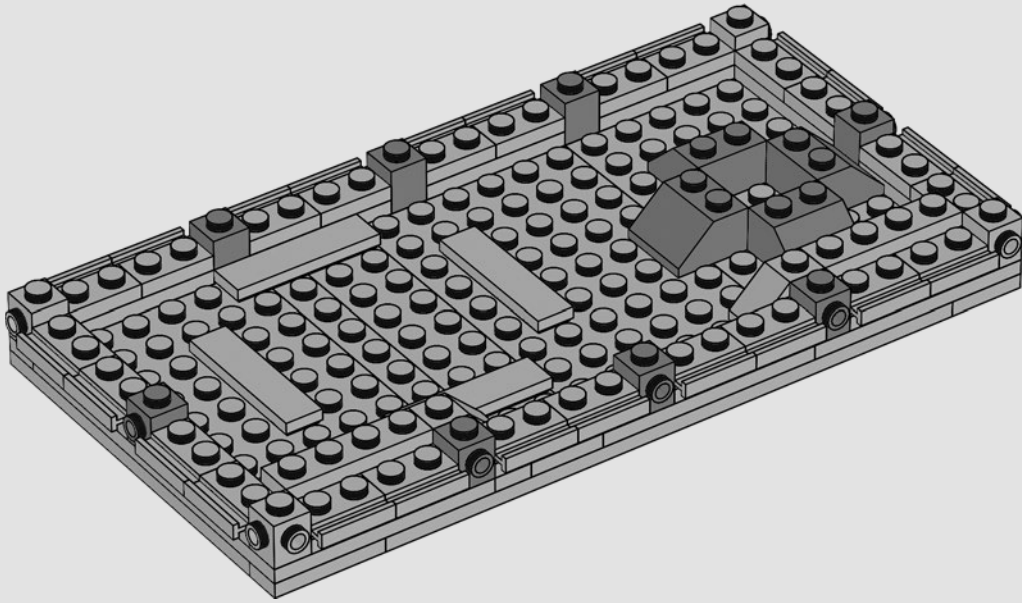

12x

460

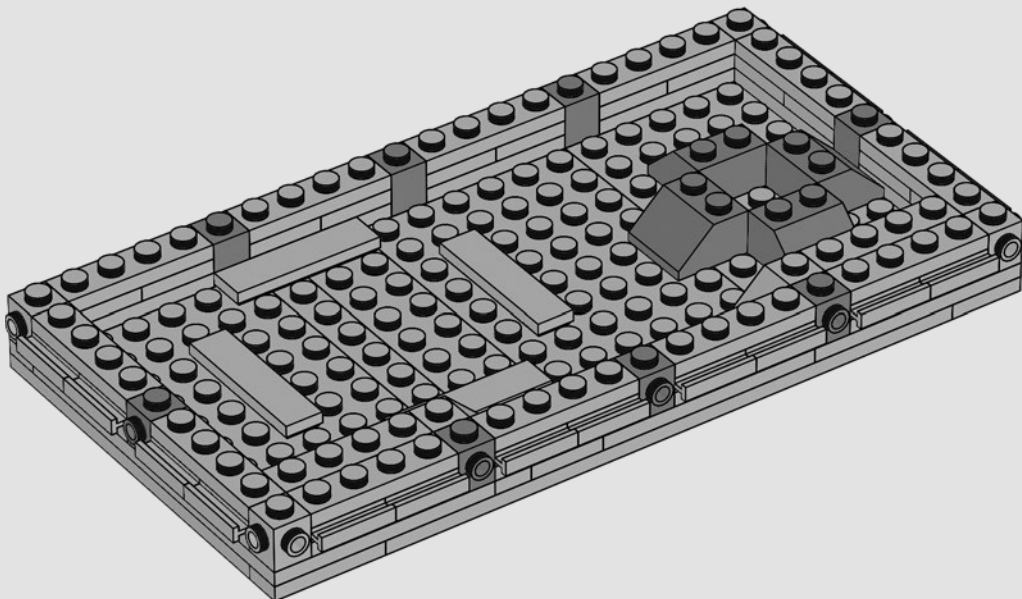



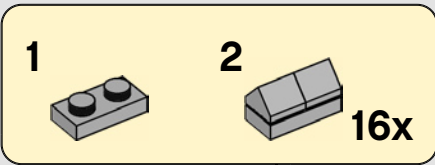
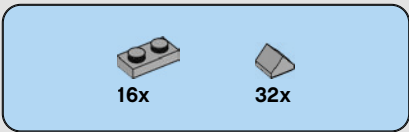

461

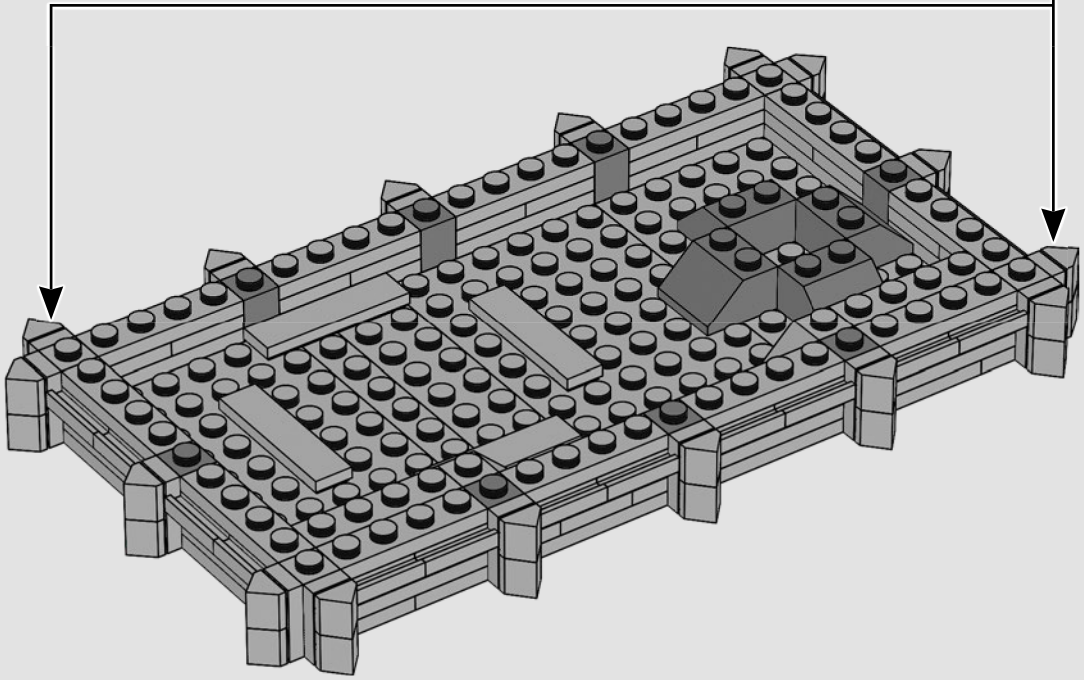

462

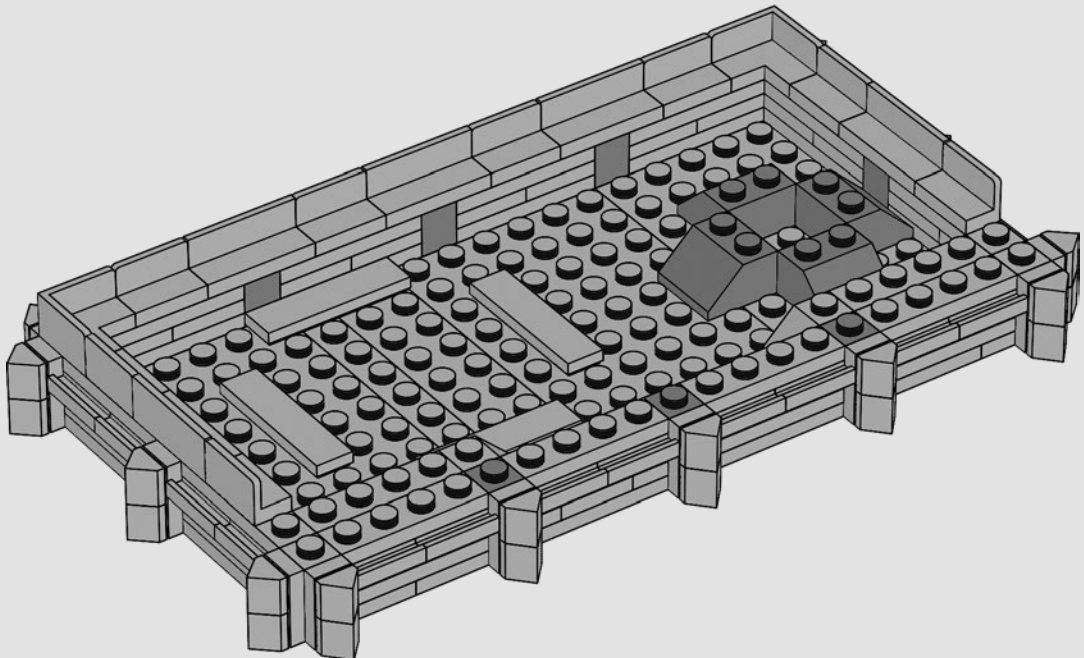

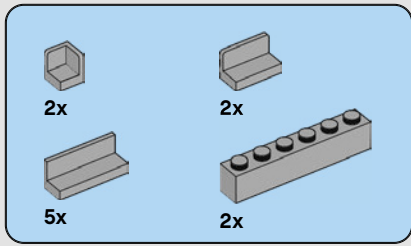

463

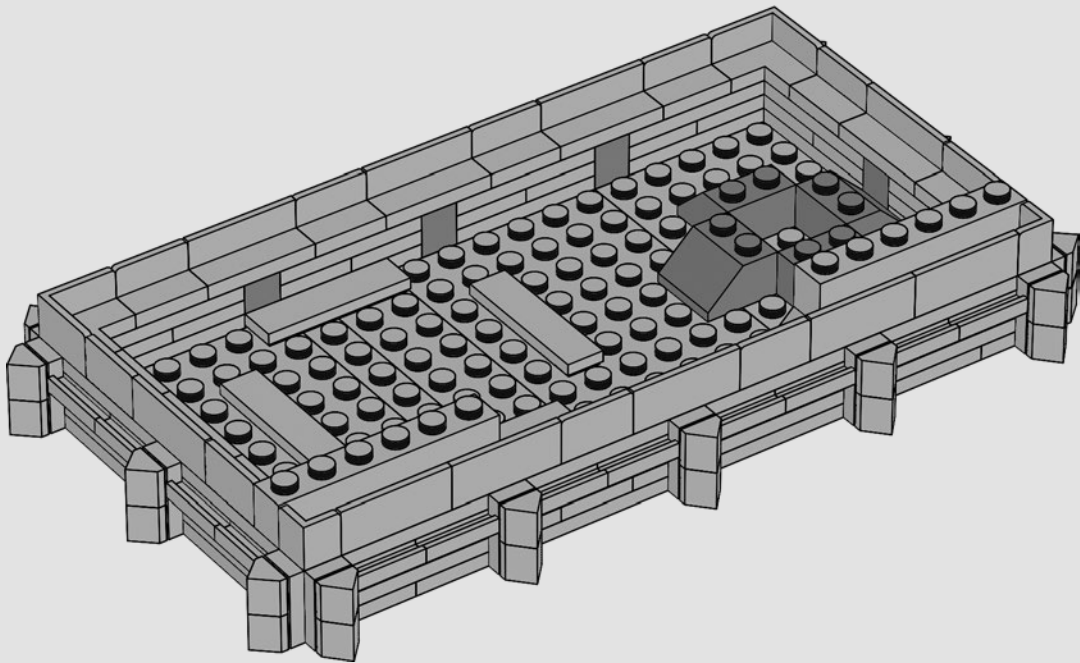

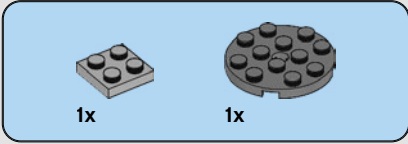
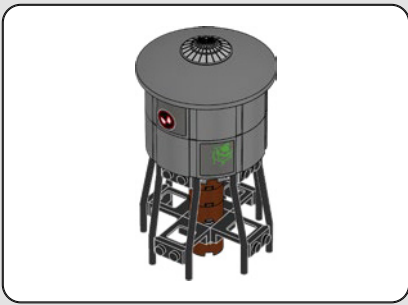

464

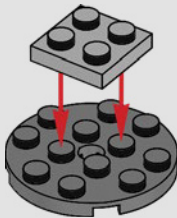

465

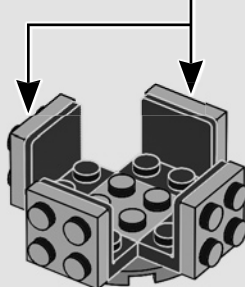
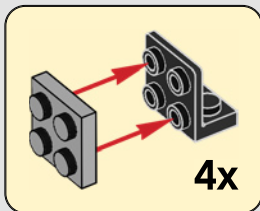

466

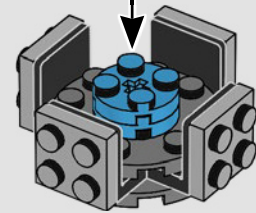
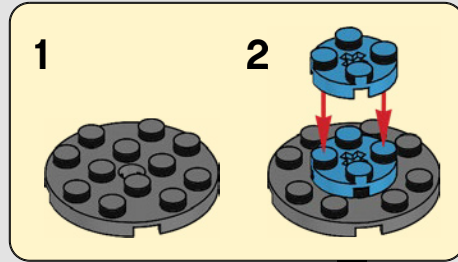

467

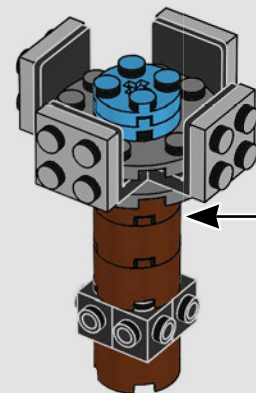
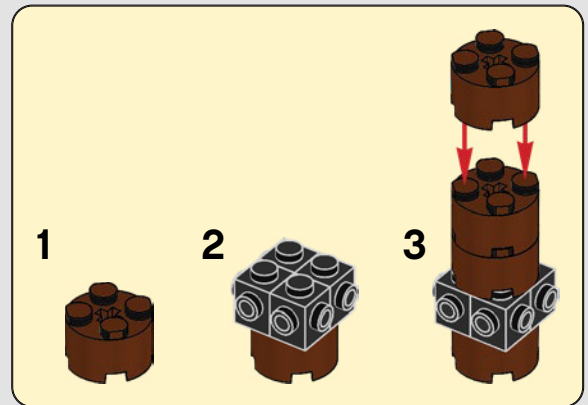



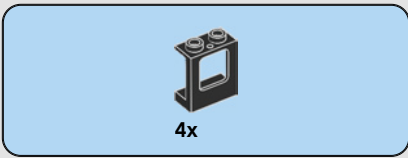

468

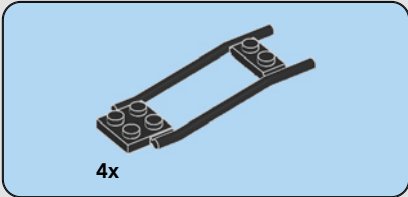
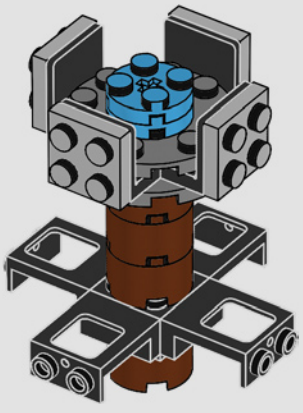

469

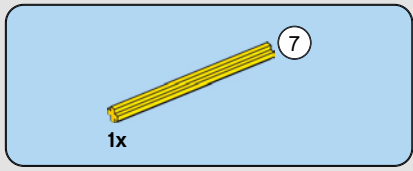
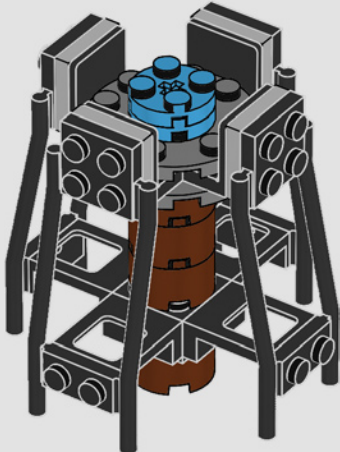

470

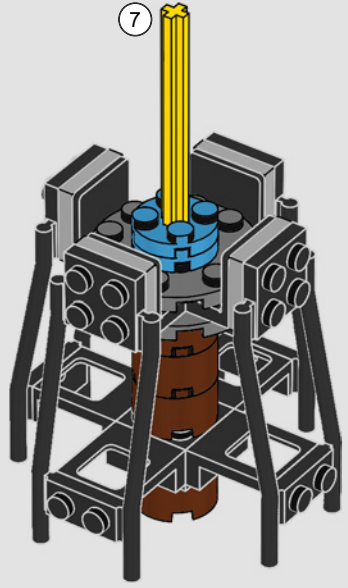

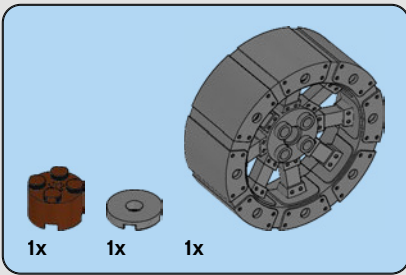

471

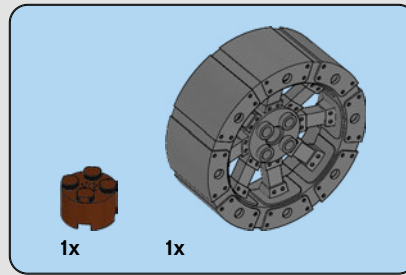
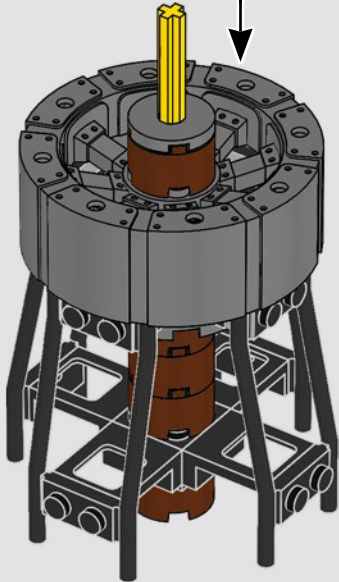
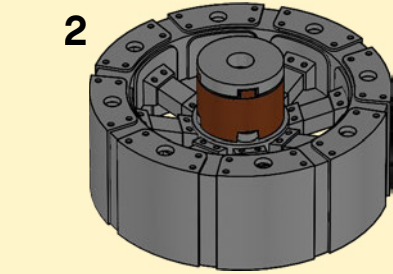
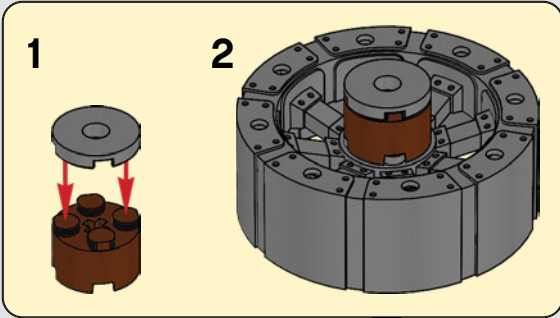

472

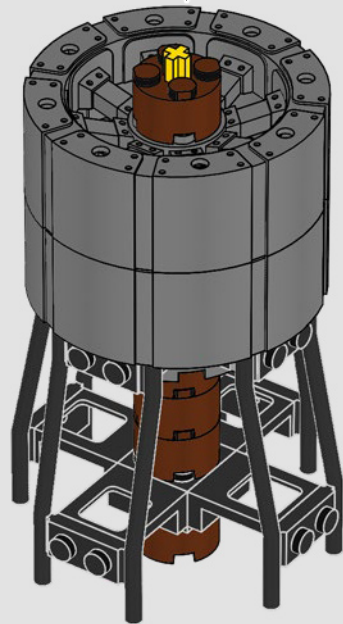
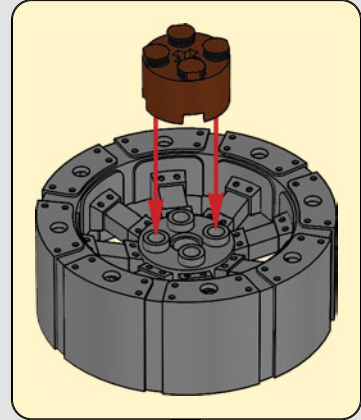

473

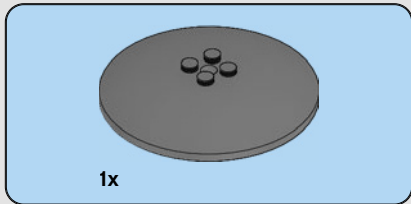
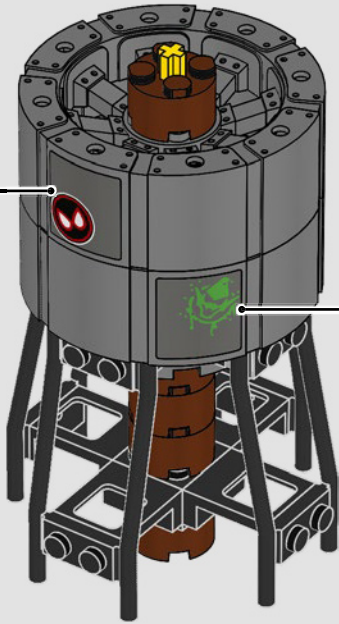

474

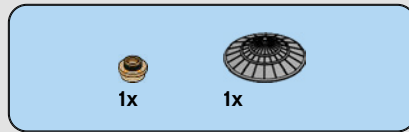
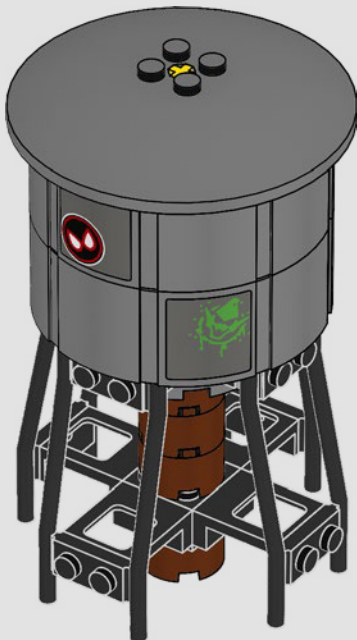

475

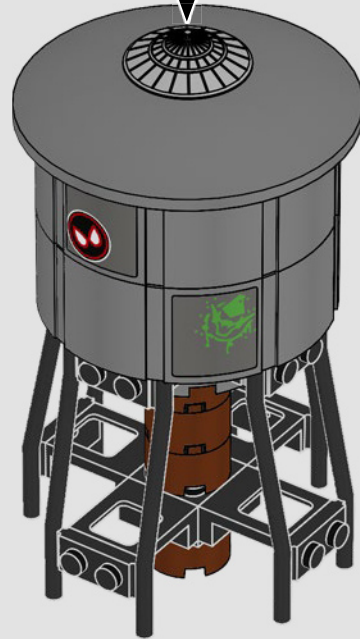
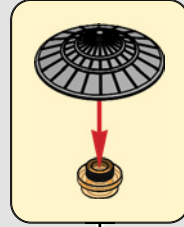



476

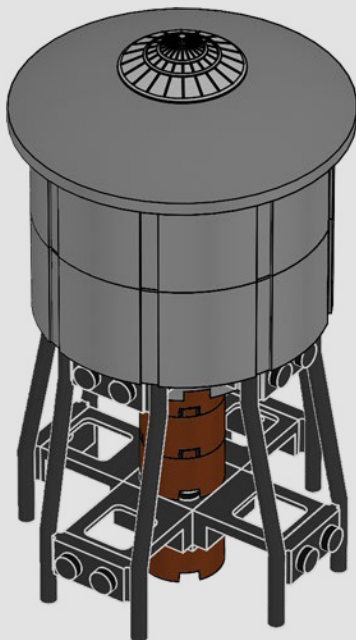

477

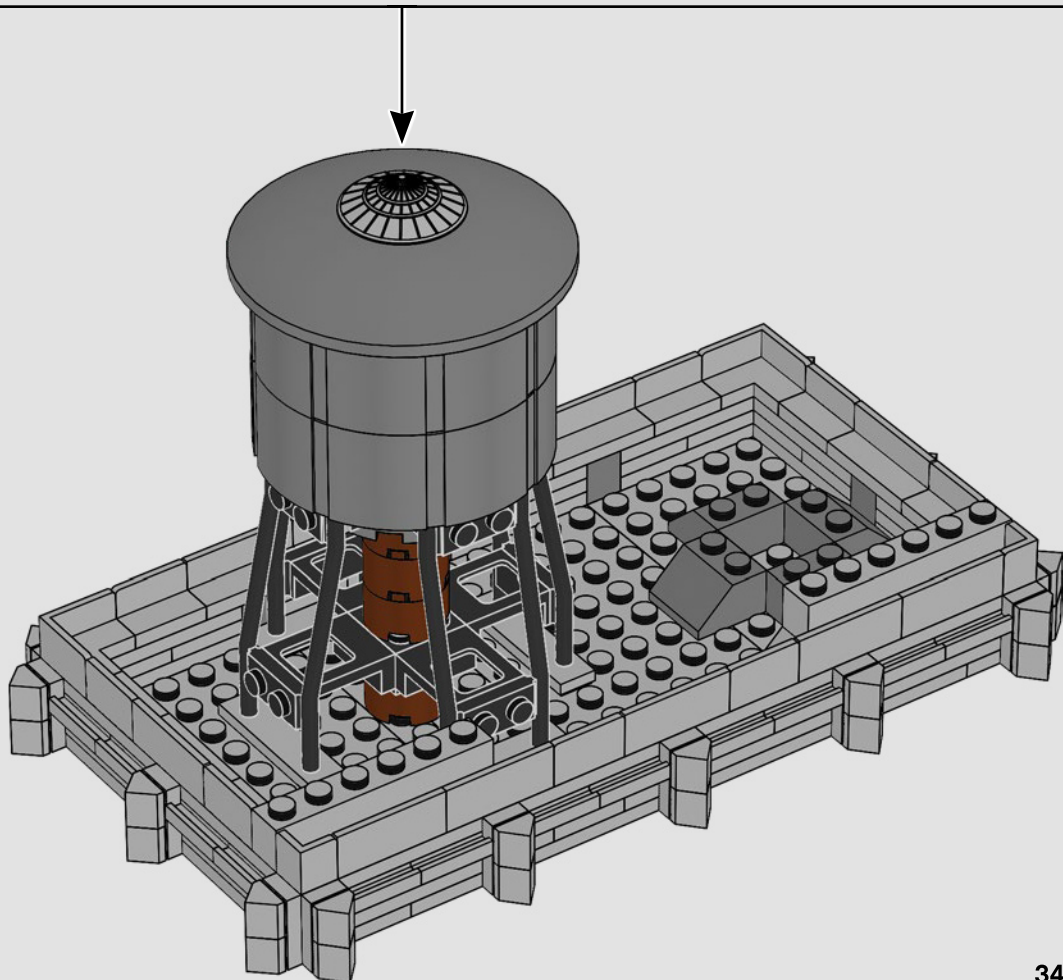

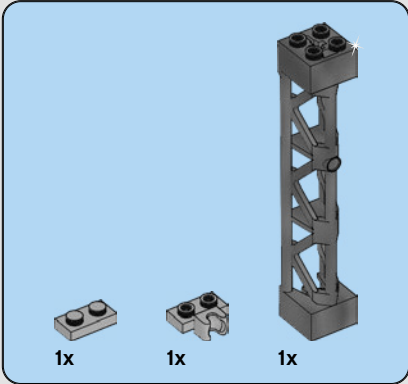
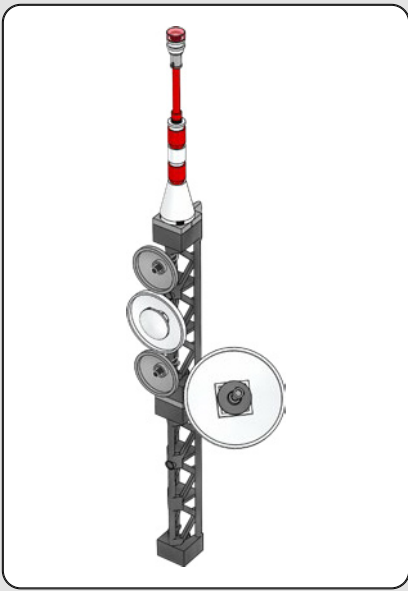

478

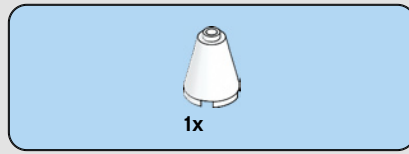
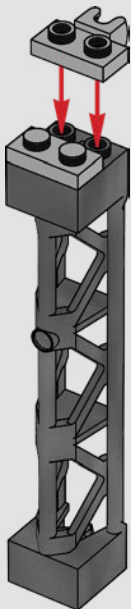

479

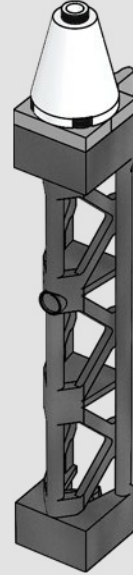

480



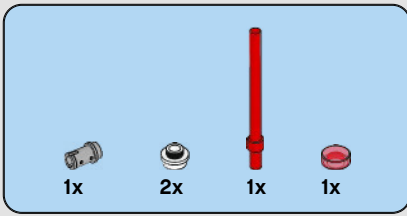

481

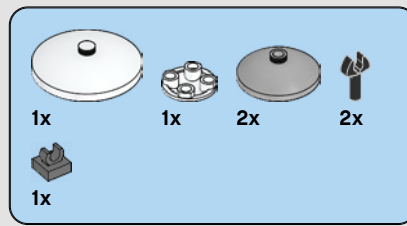
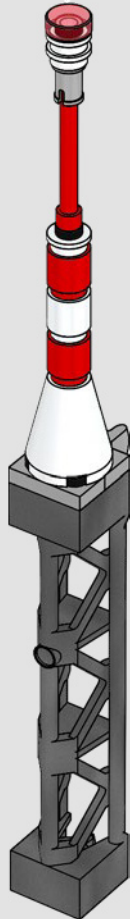
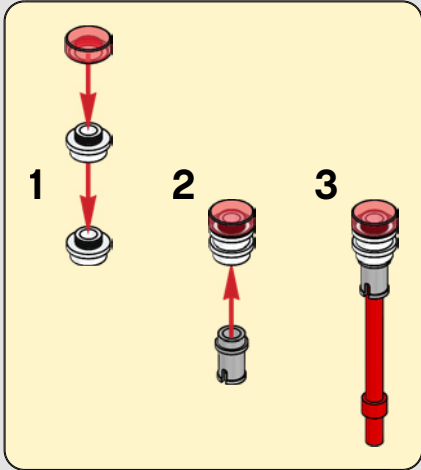

482

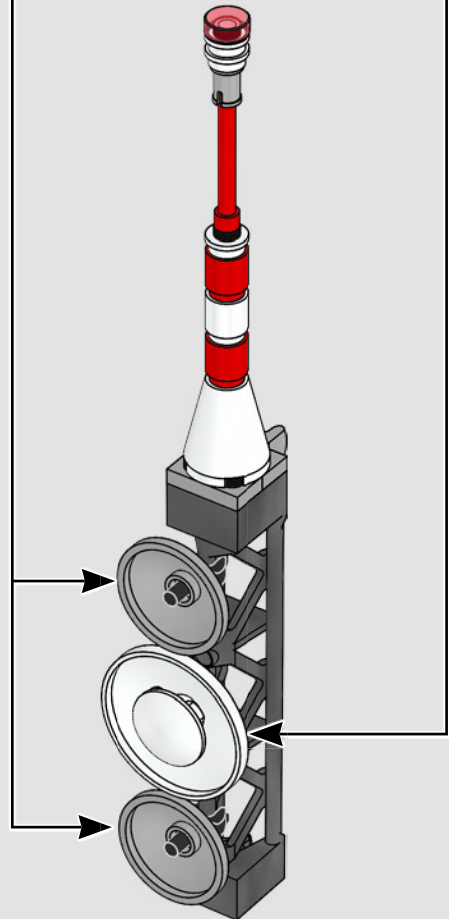
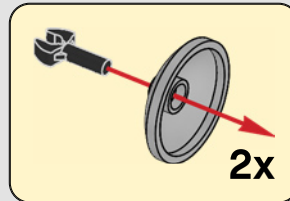
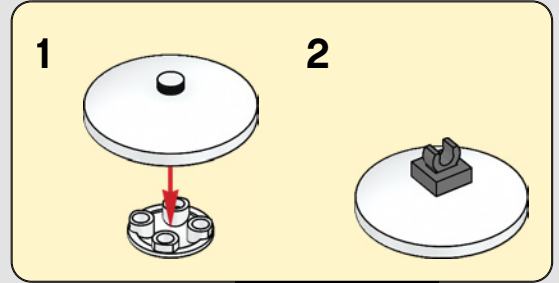



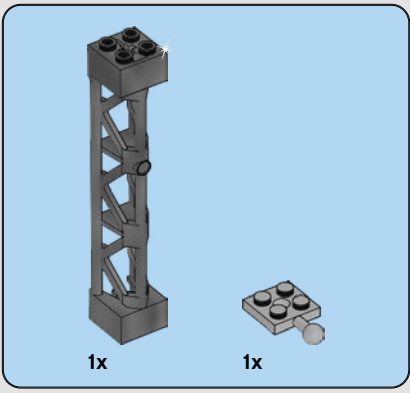

483

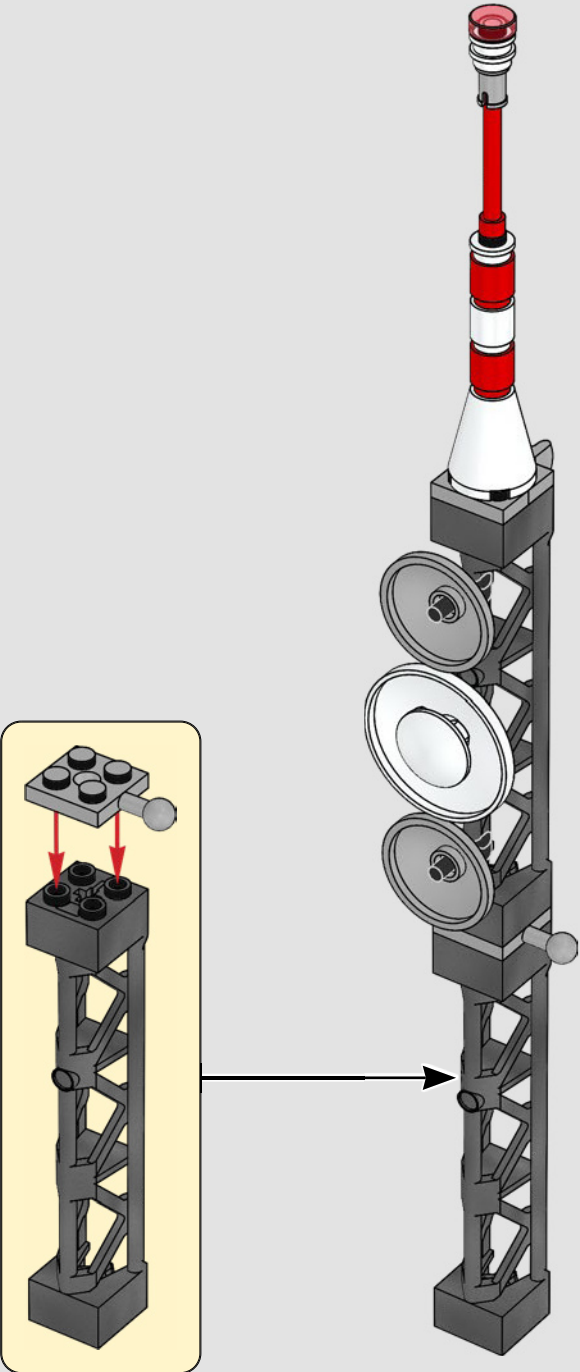

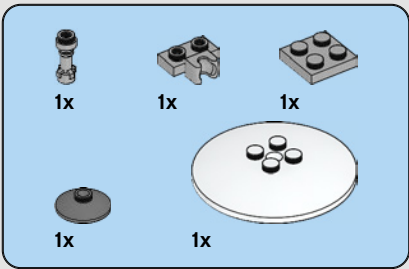

484

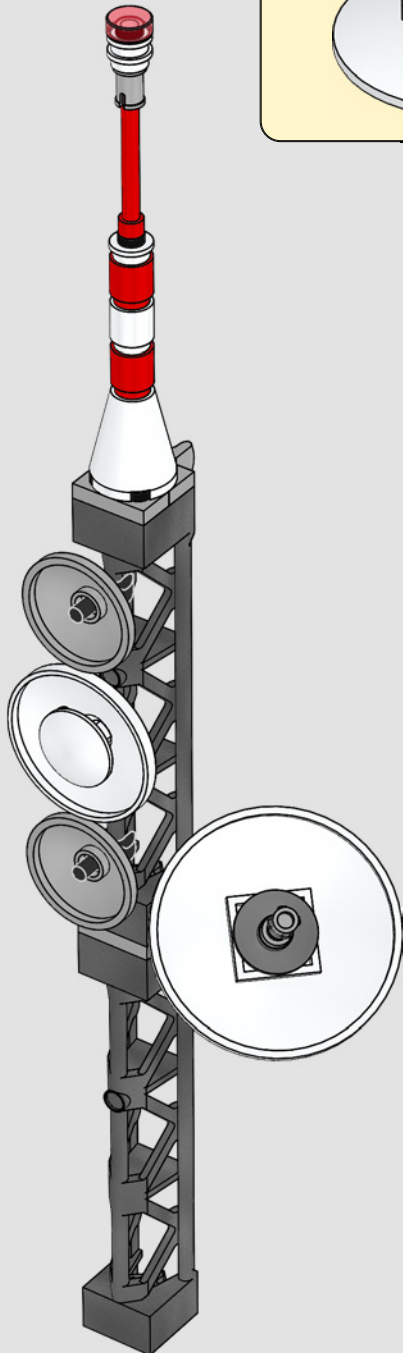
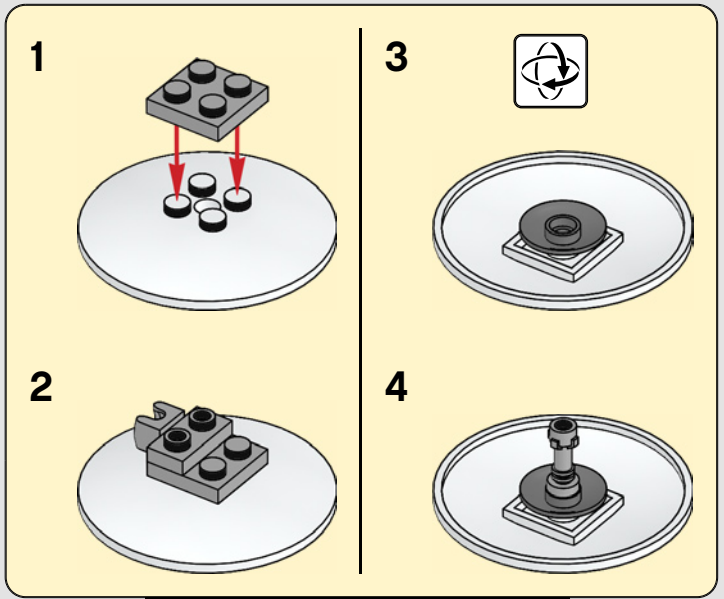

485

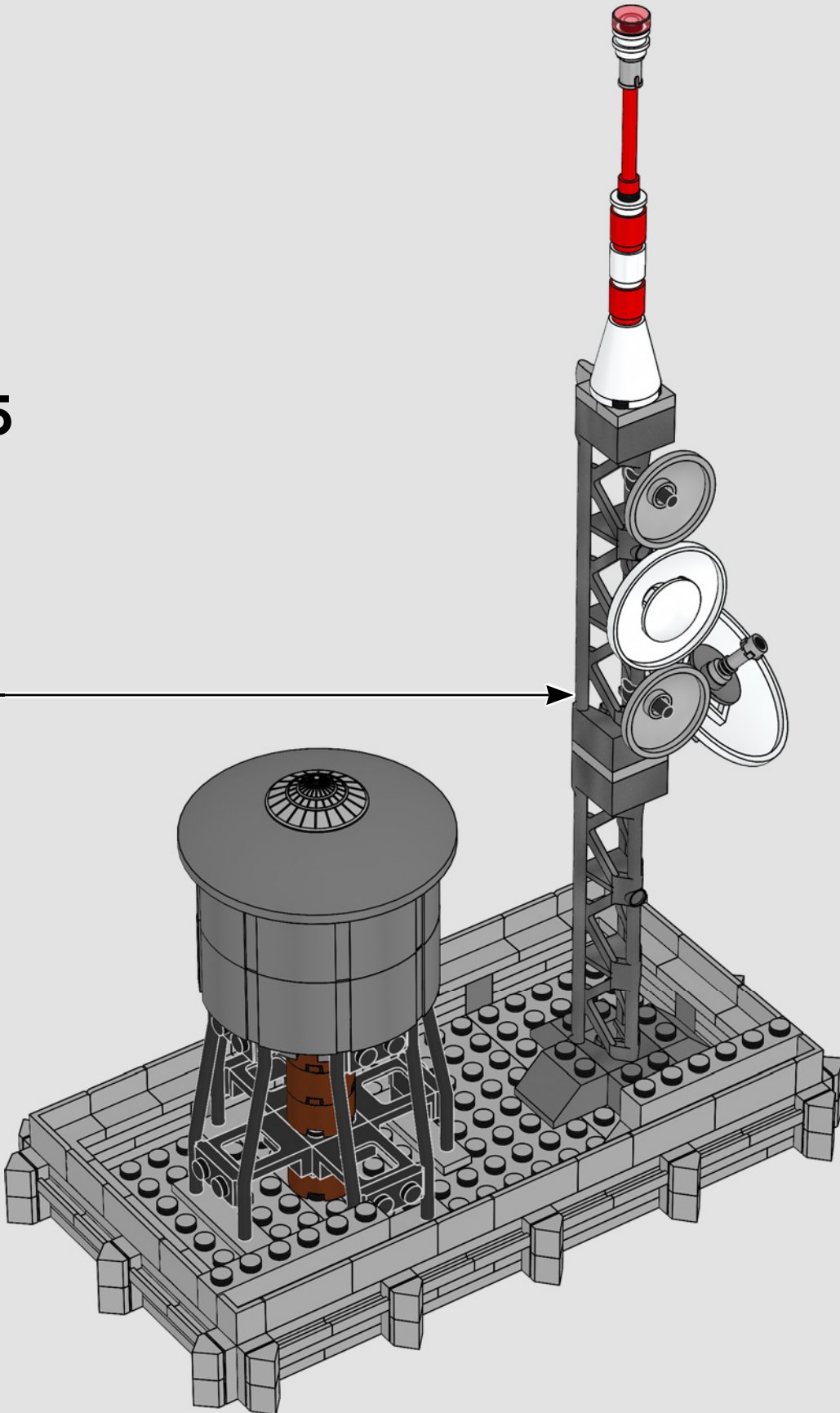



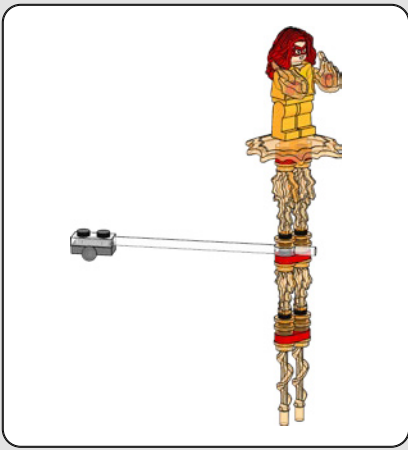

486



487



488

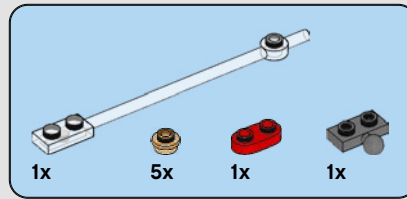

489

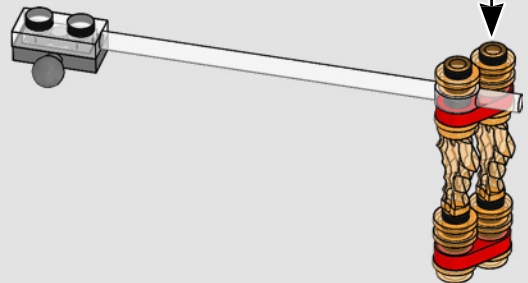
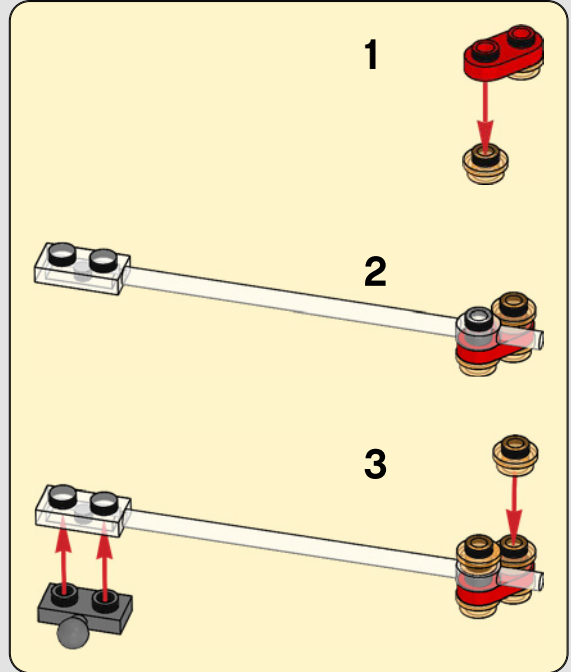



490

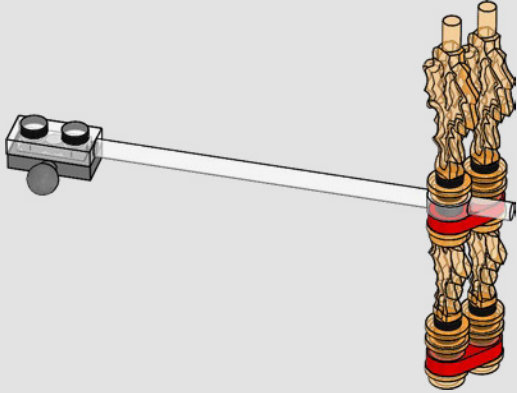

492

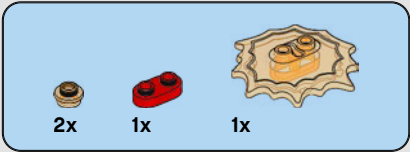
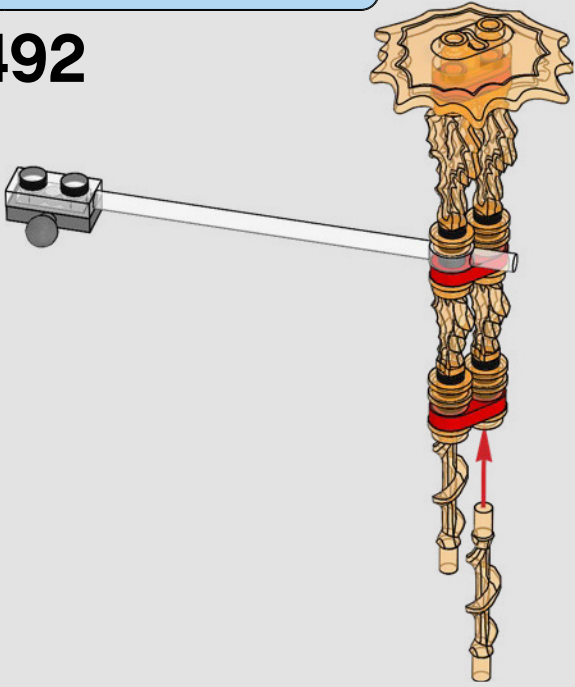

491

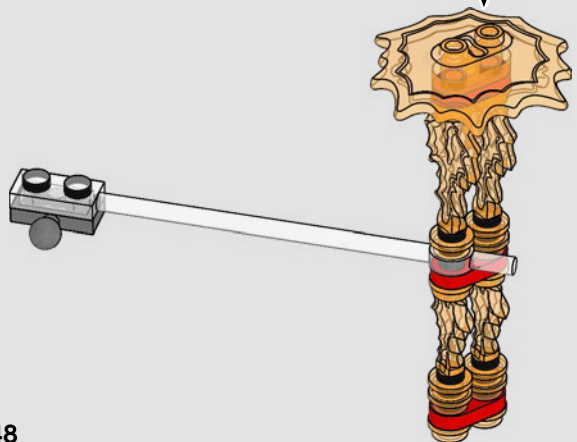
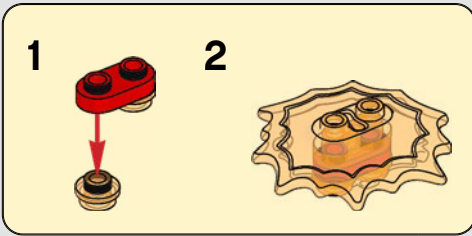

493

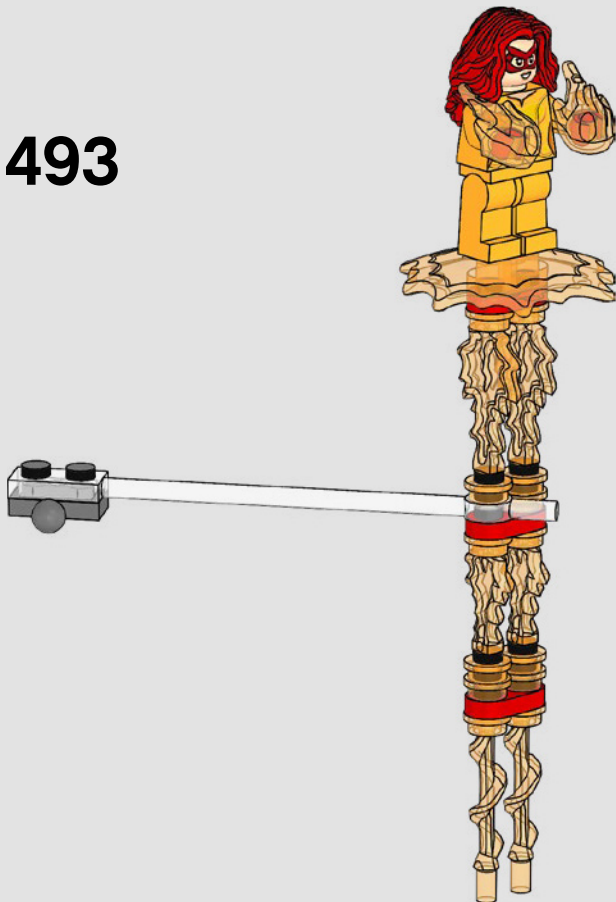

494

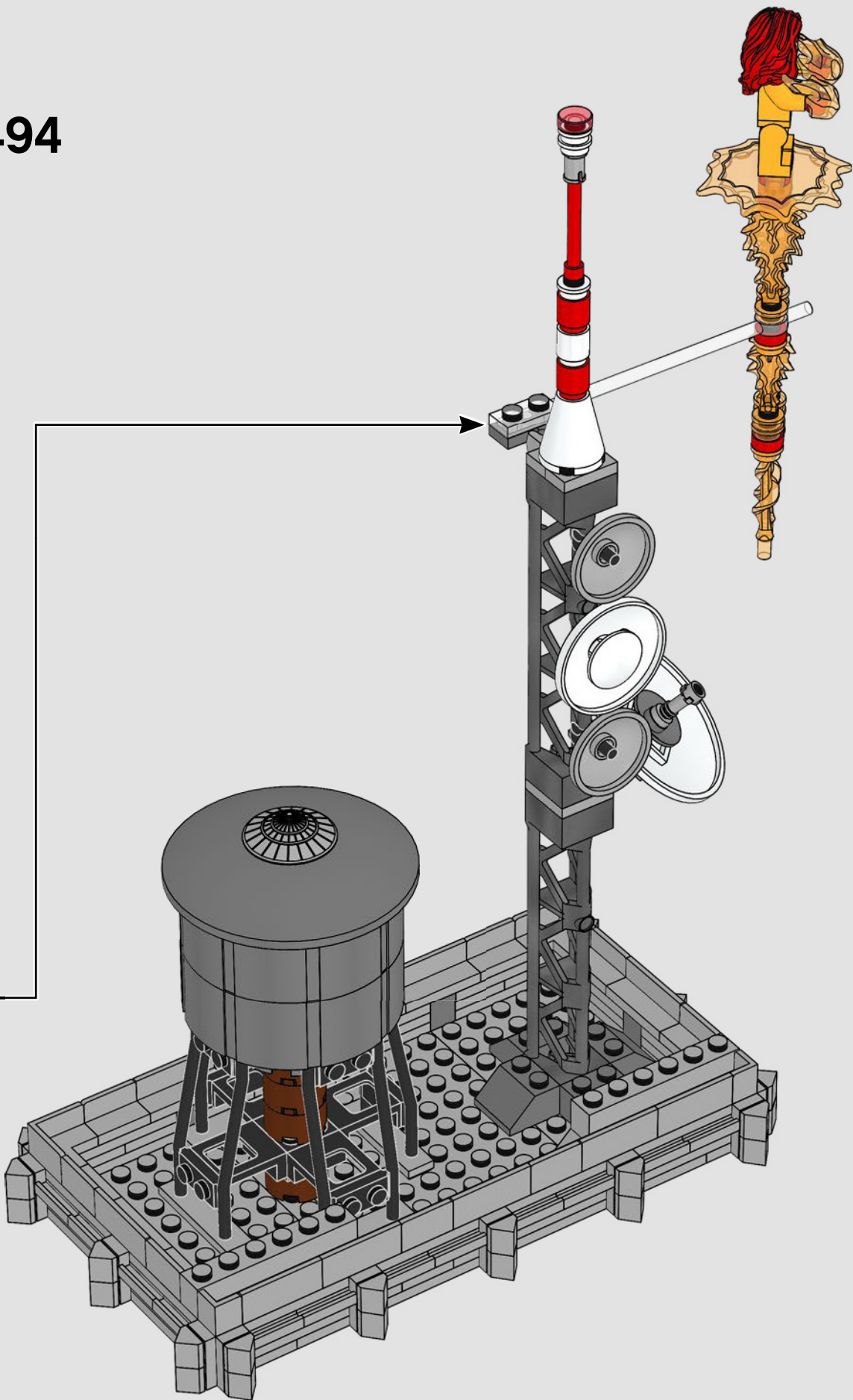



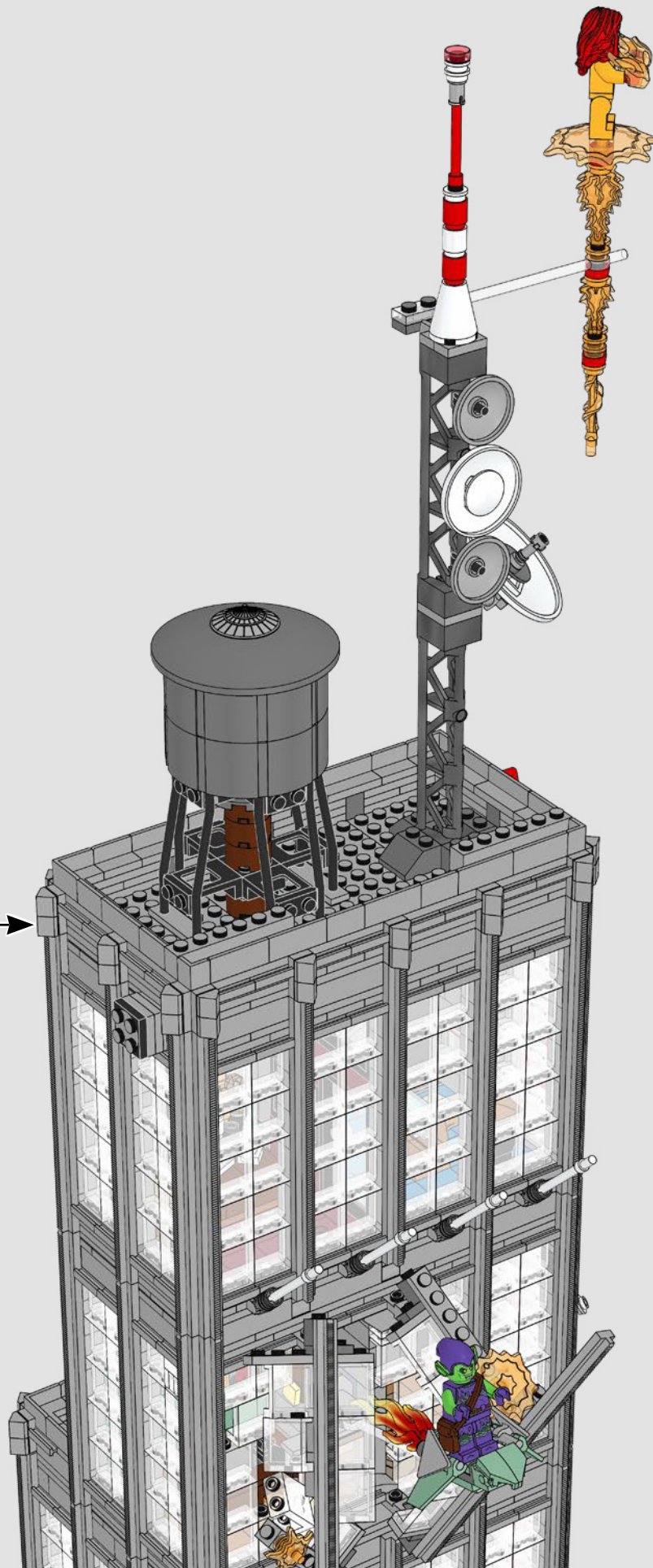

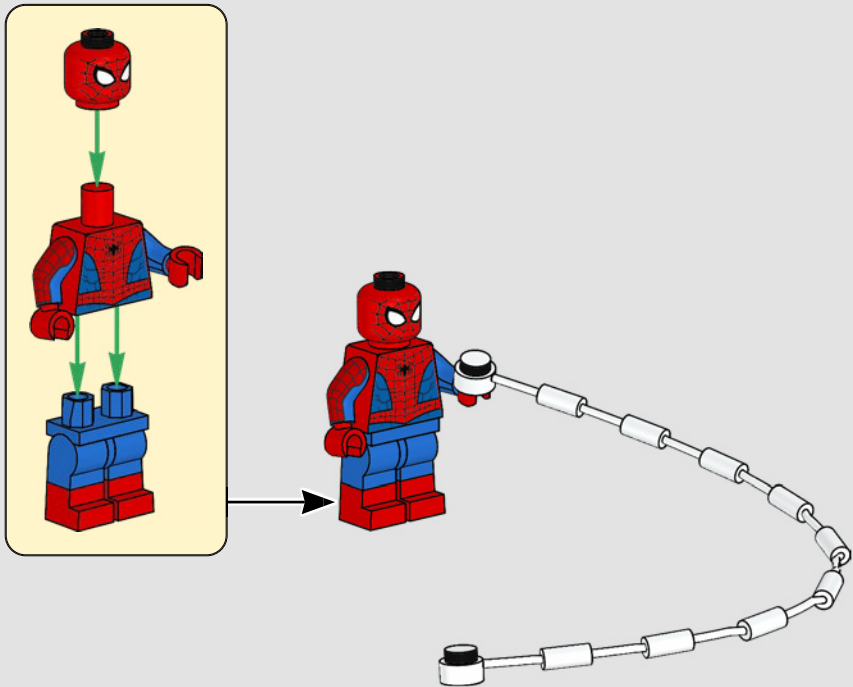
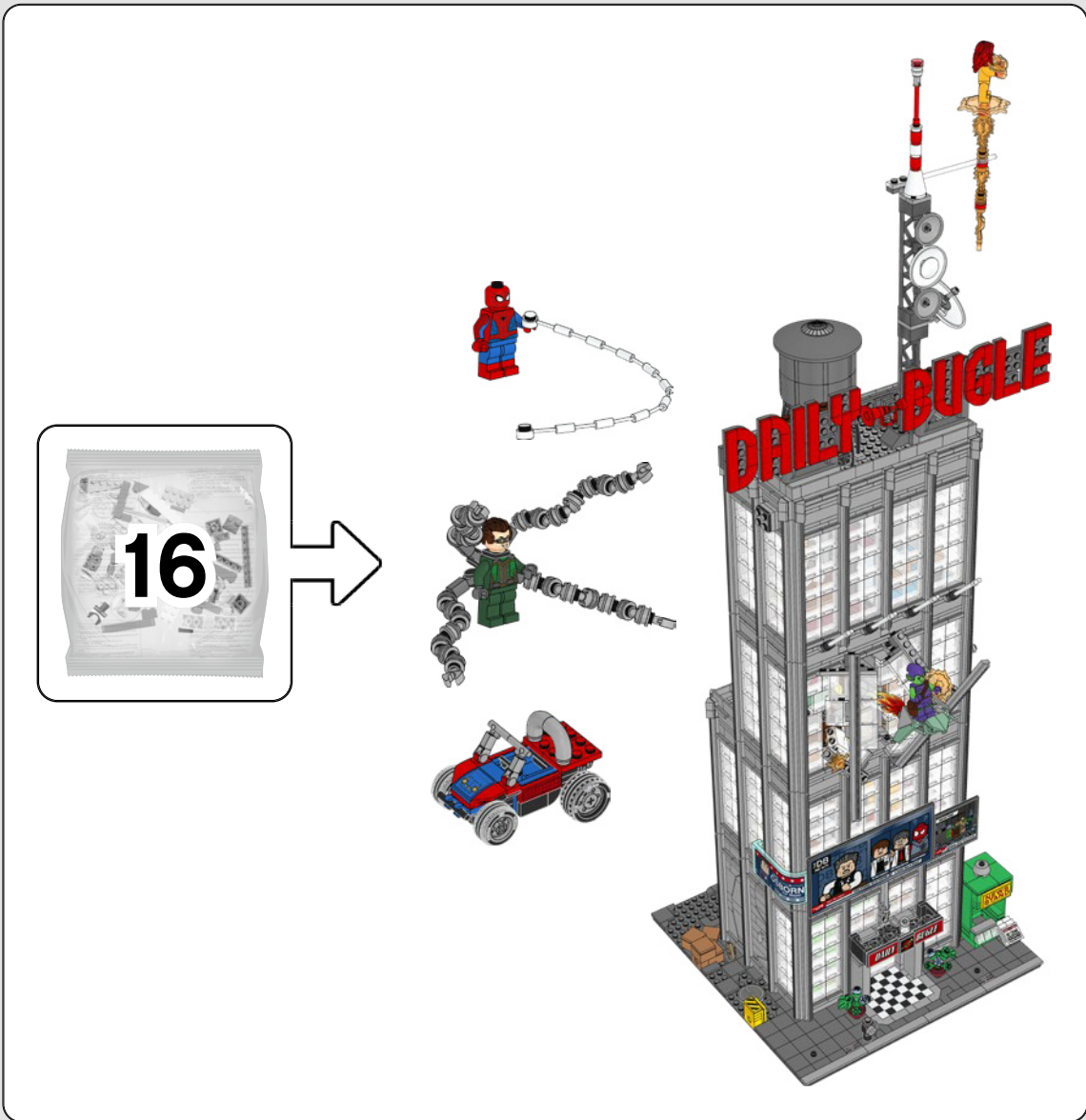

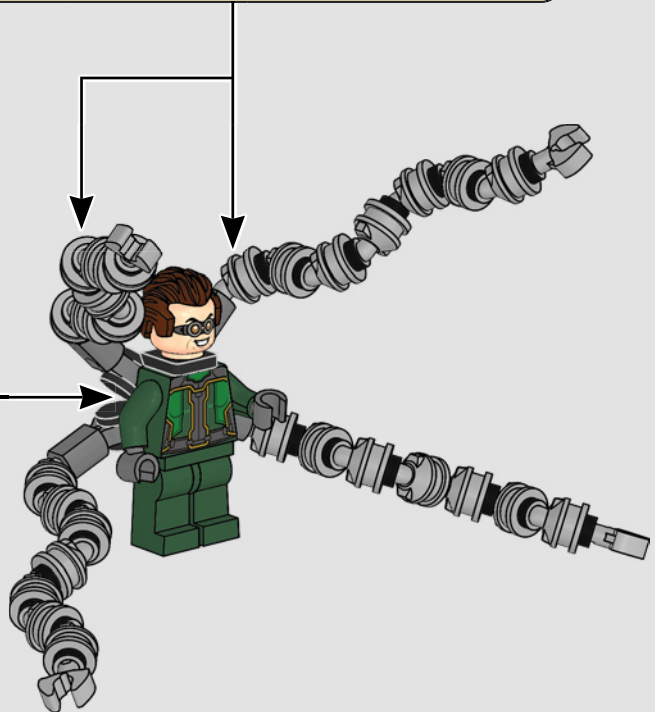
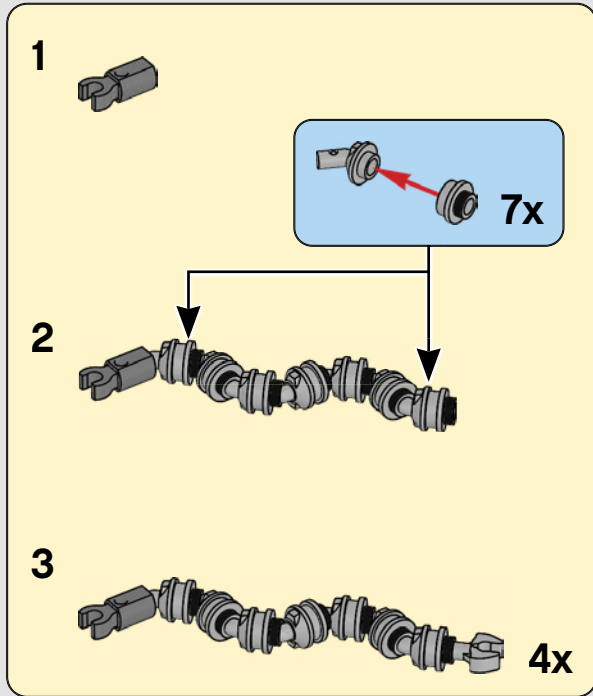
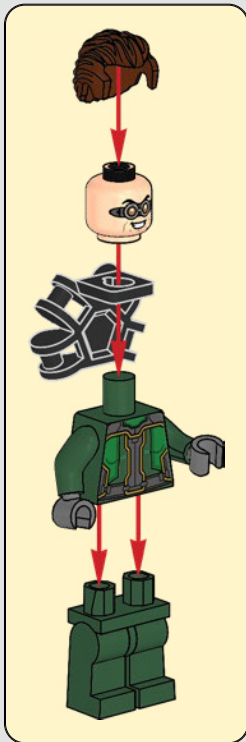



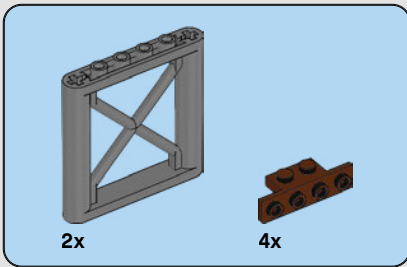

496

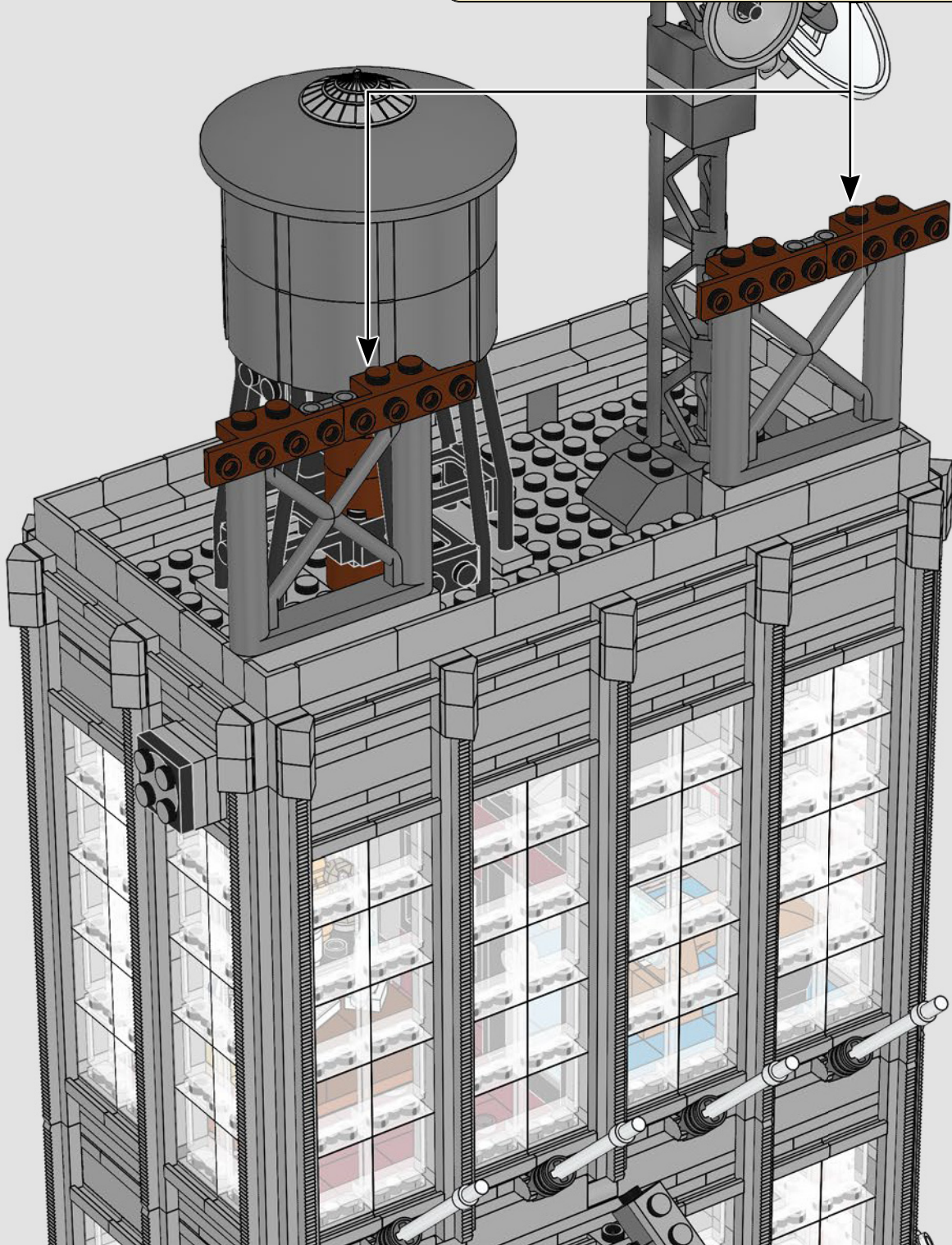
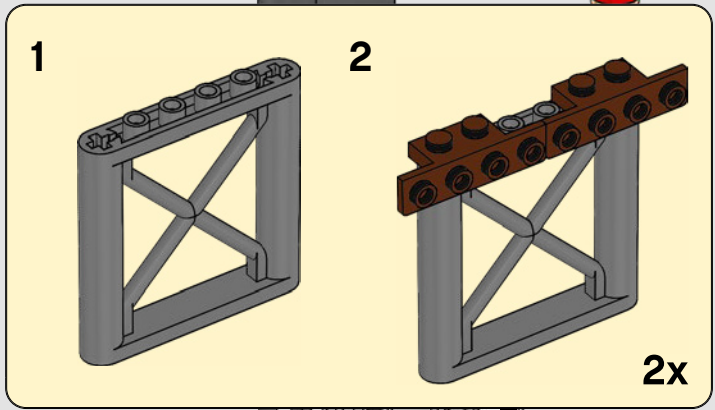

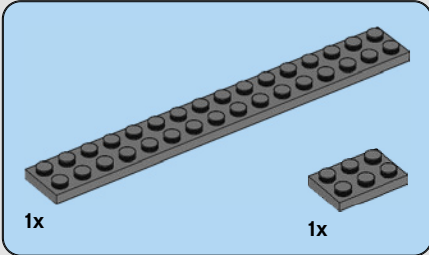
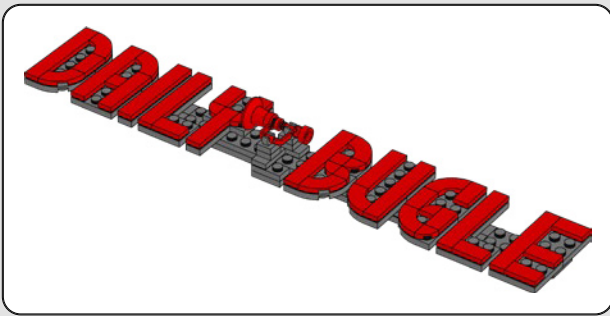

497

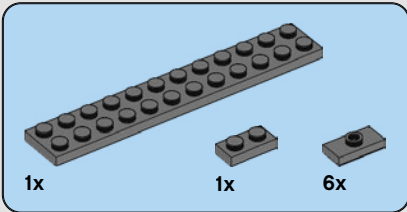
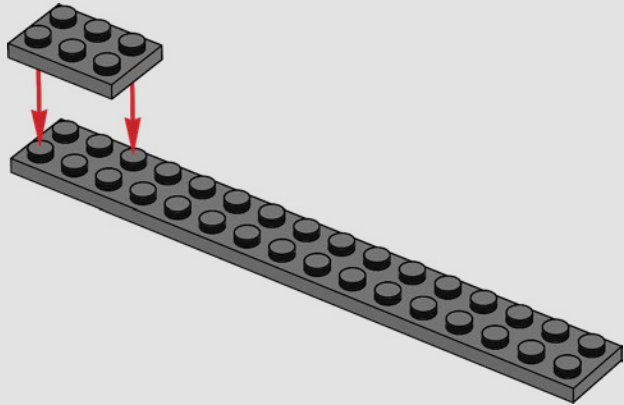

498

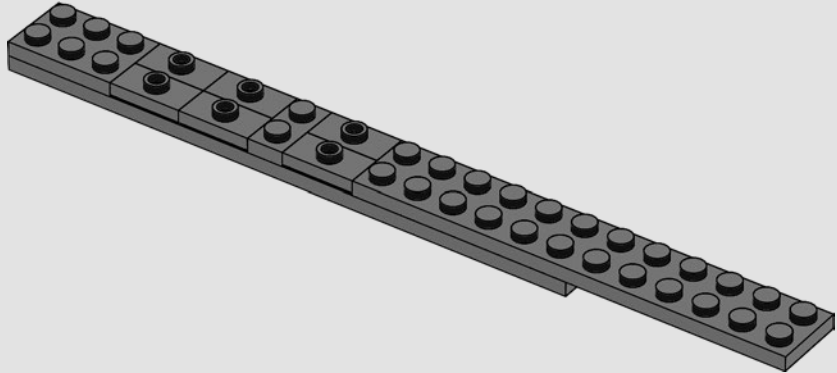

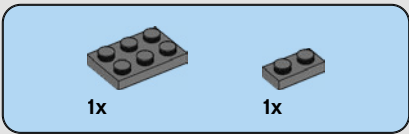

499

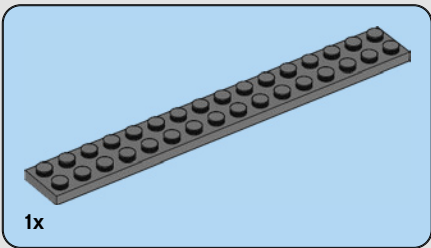
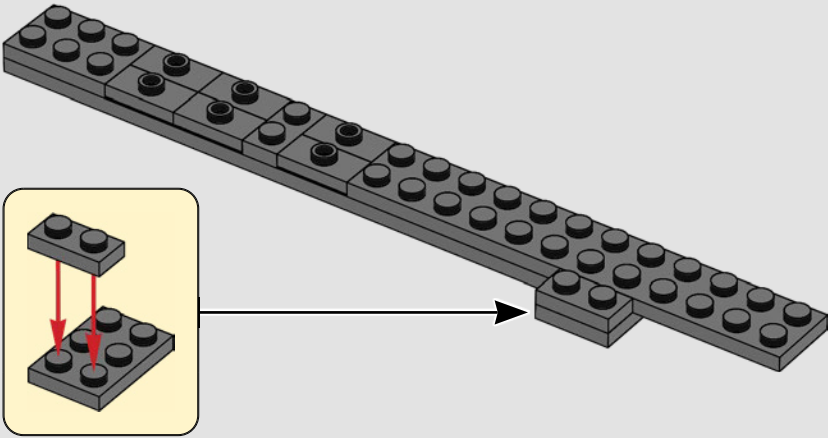

500

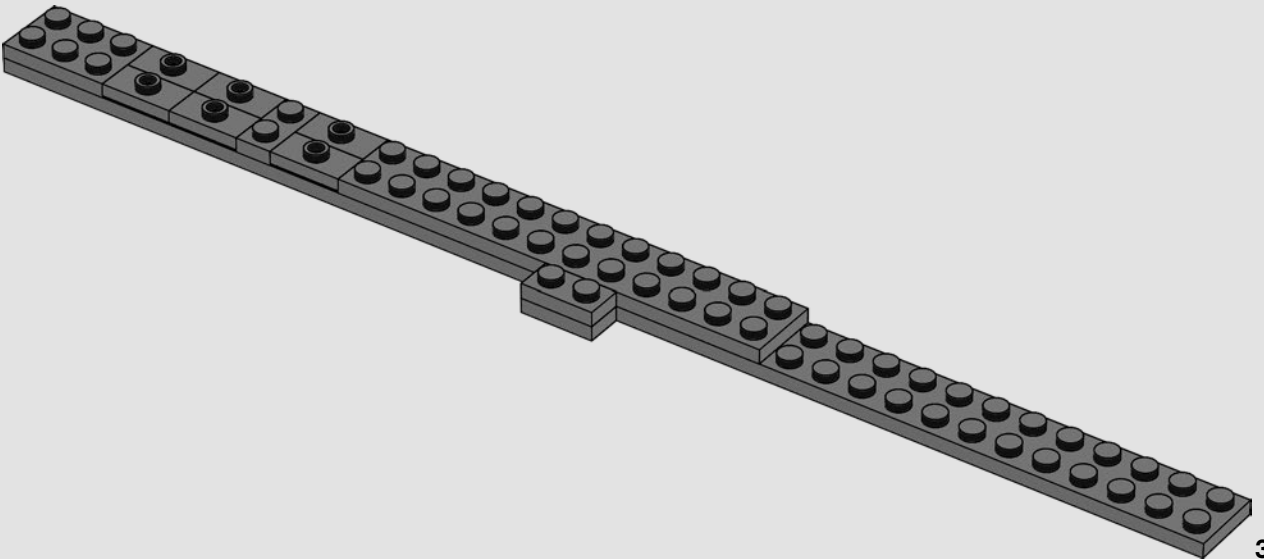



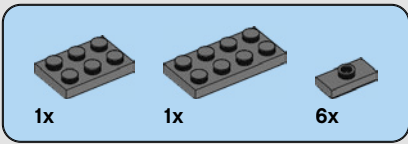

# 501

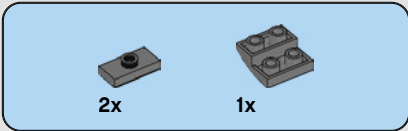
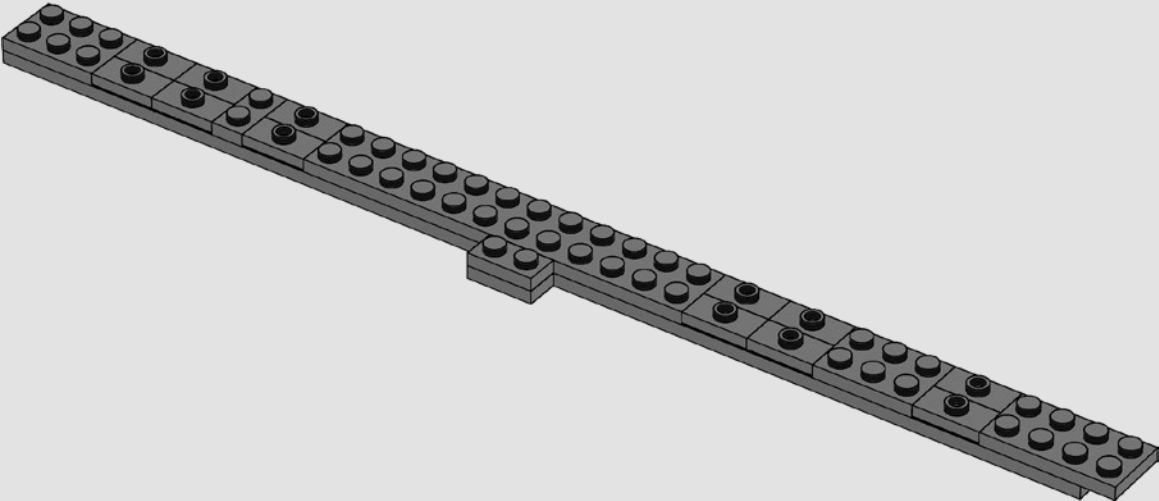

# 502

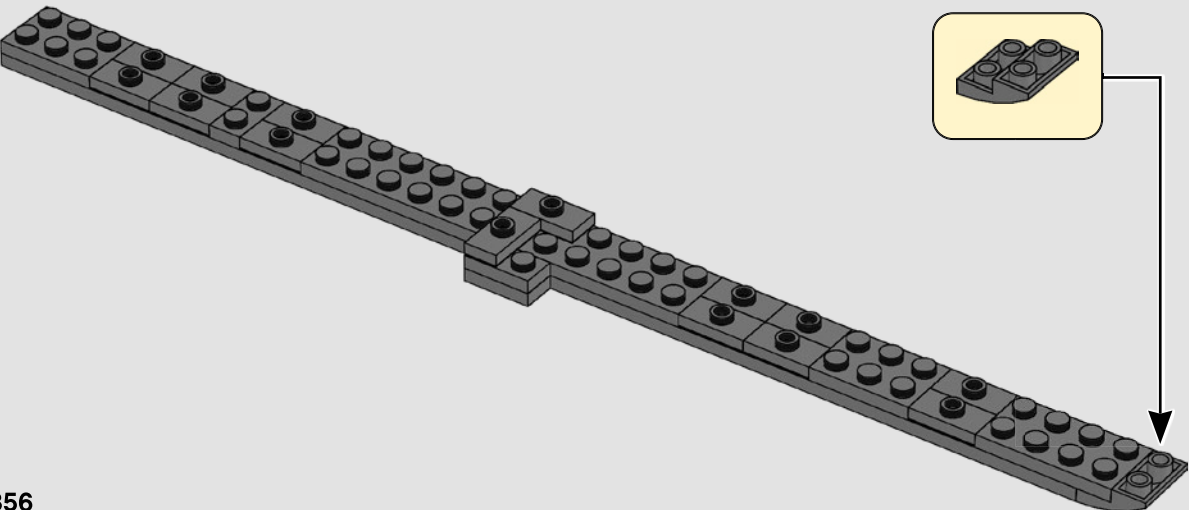

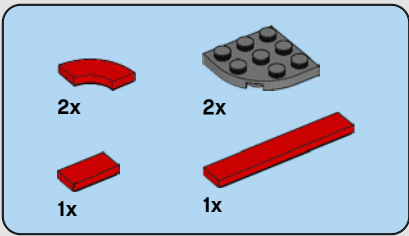

503

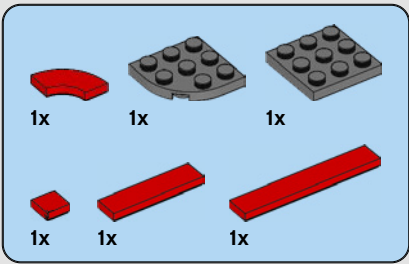
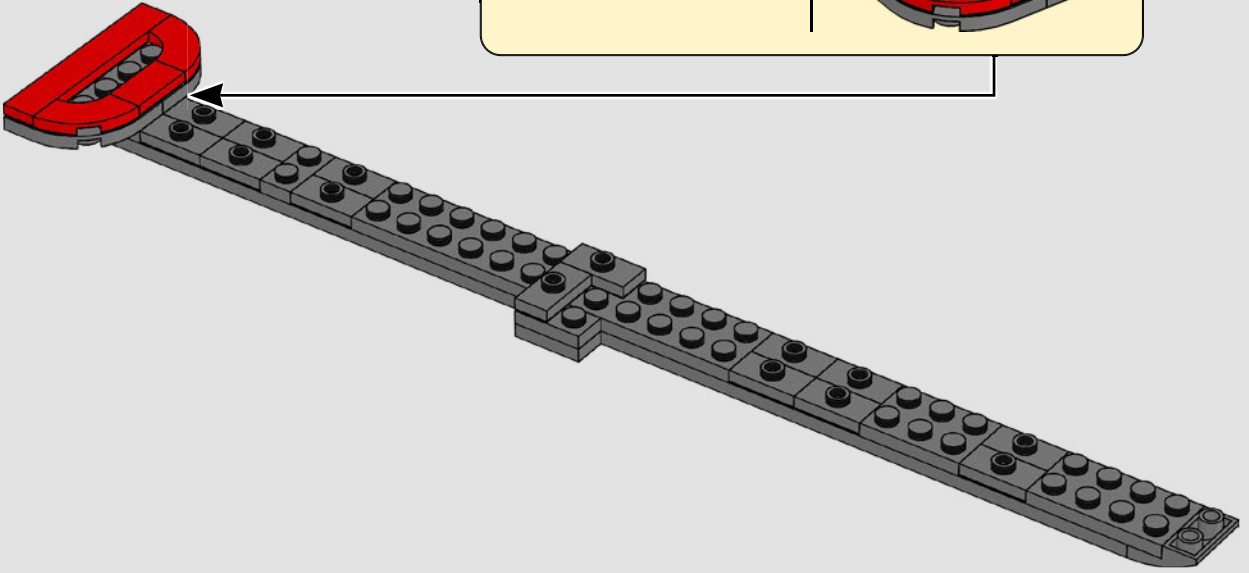
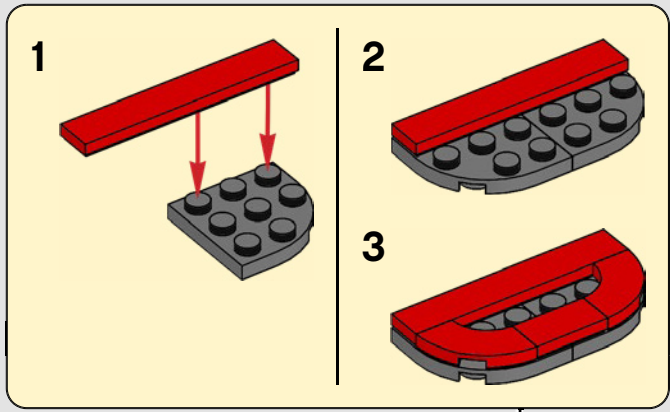

504

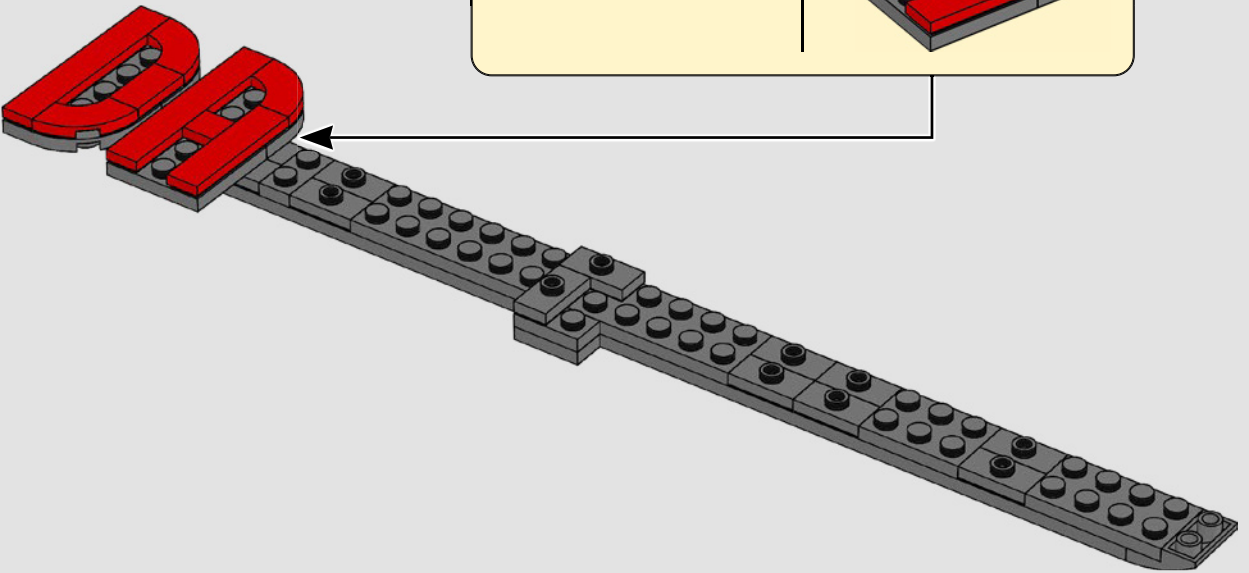
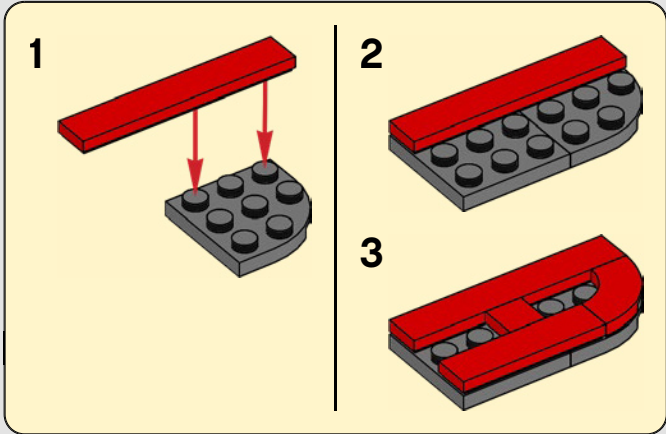

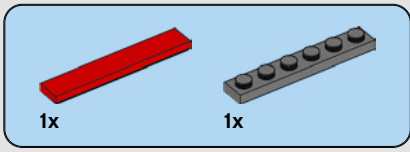

505

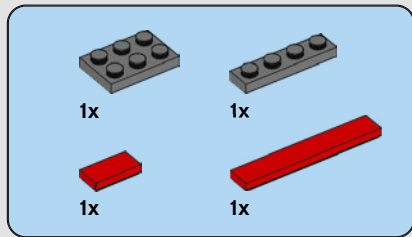
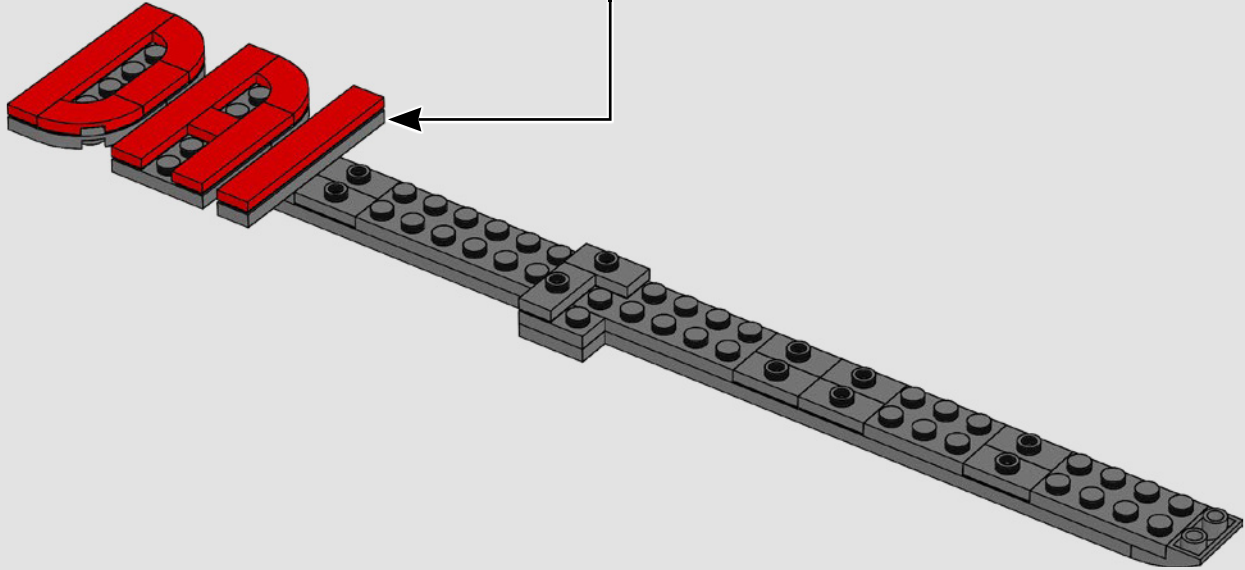
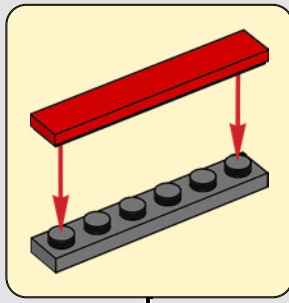

506

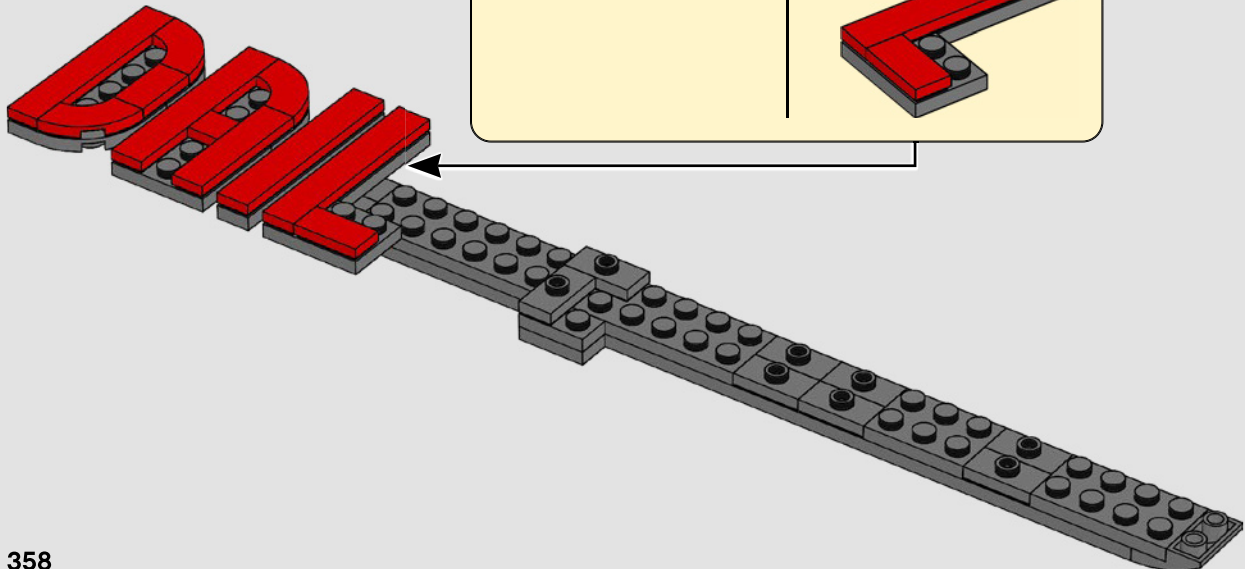
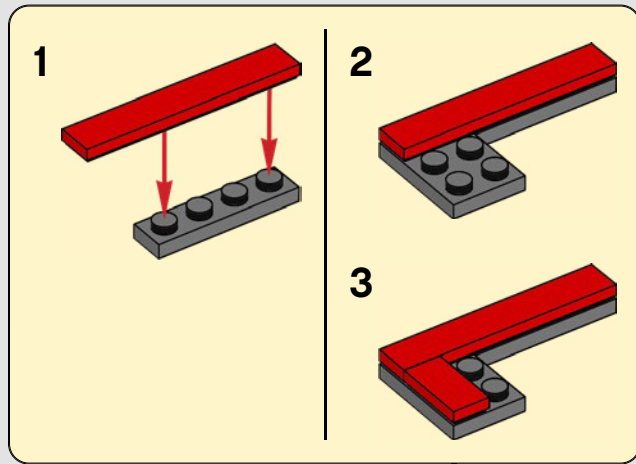



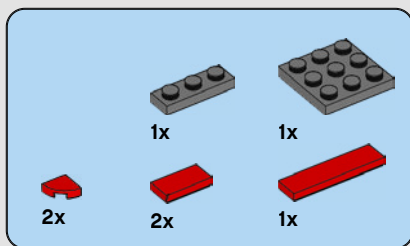

507

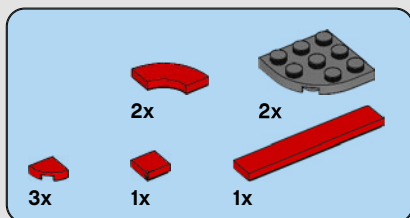
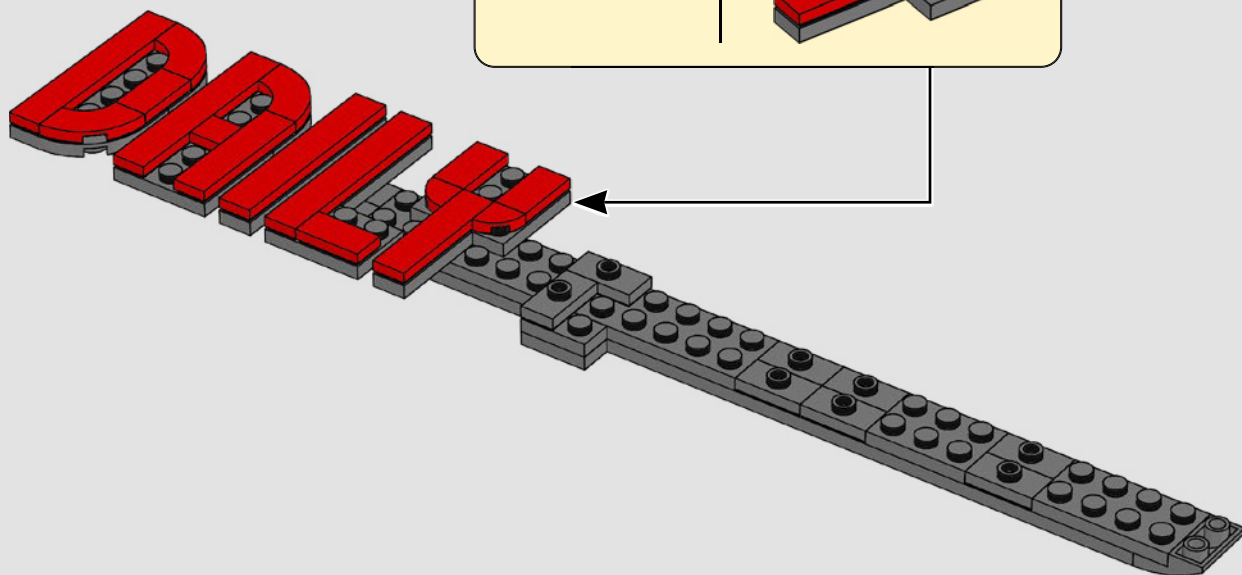
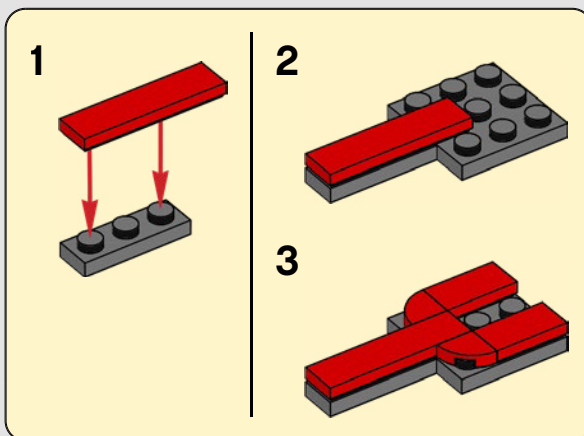

508

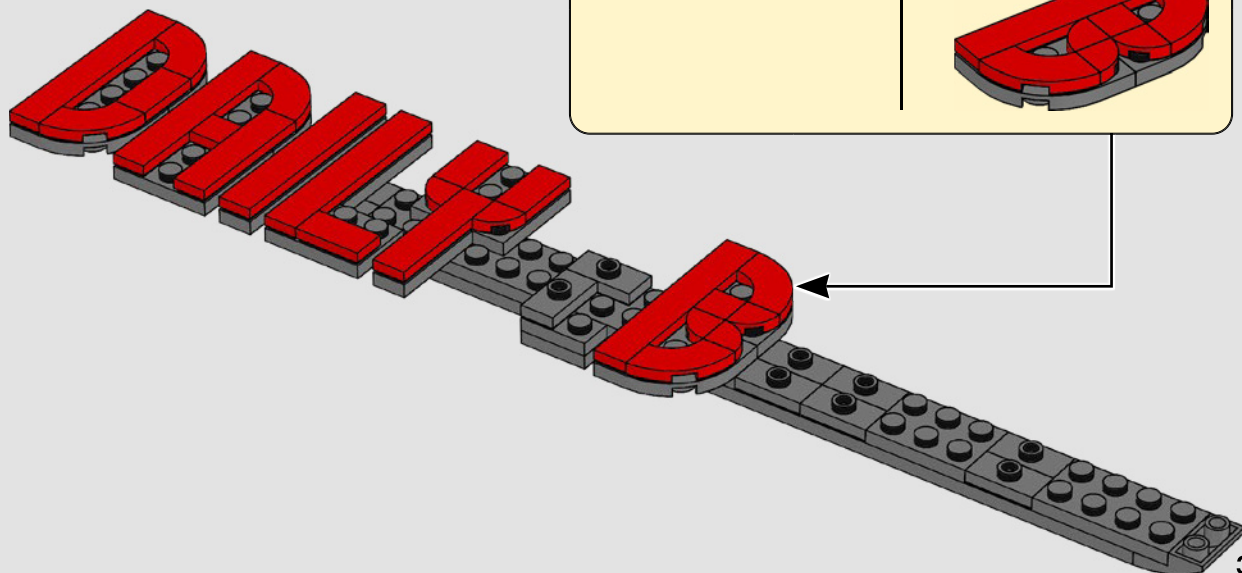
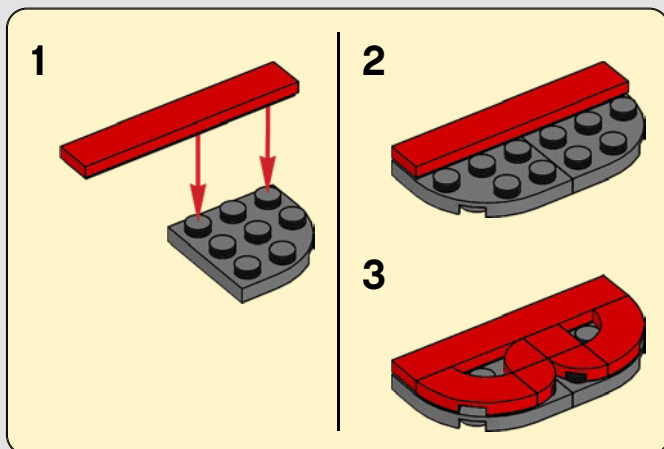

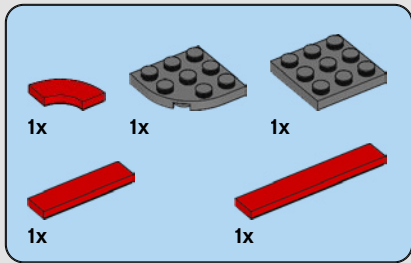

509

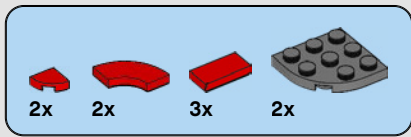
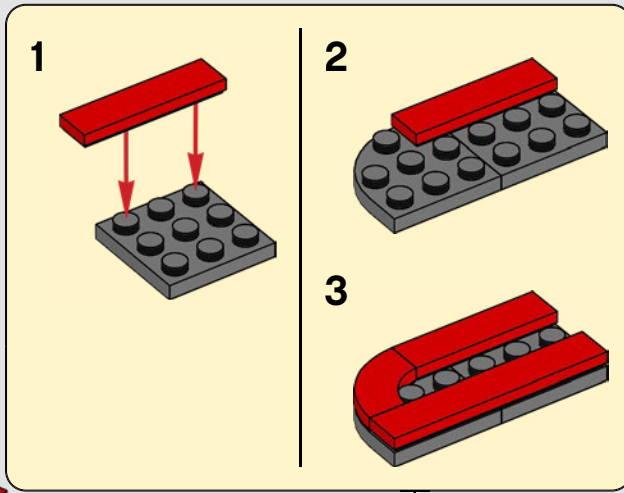
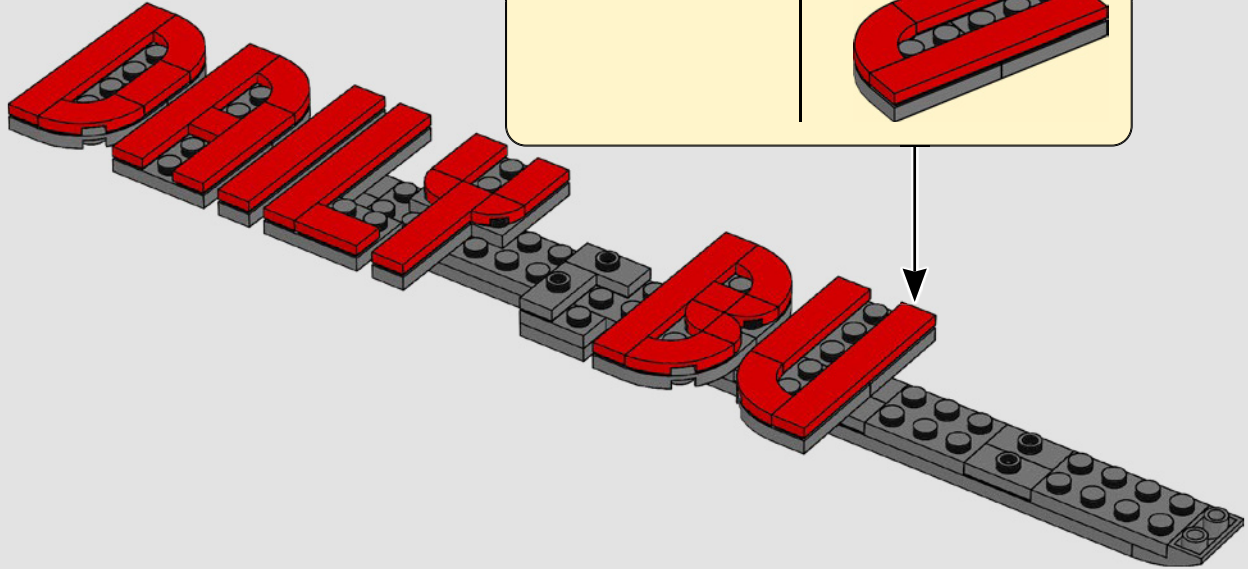

510

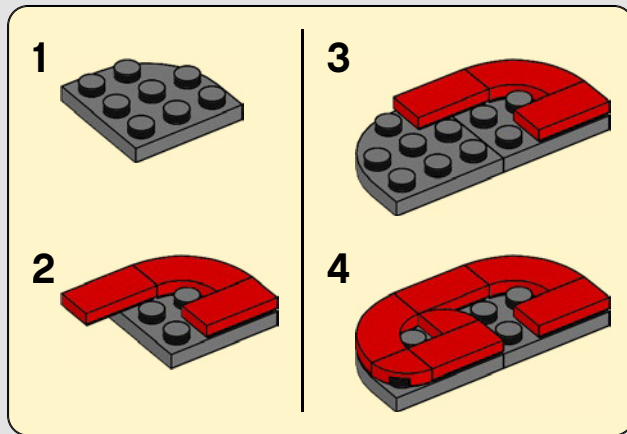
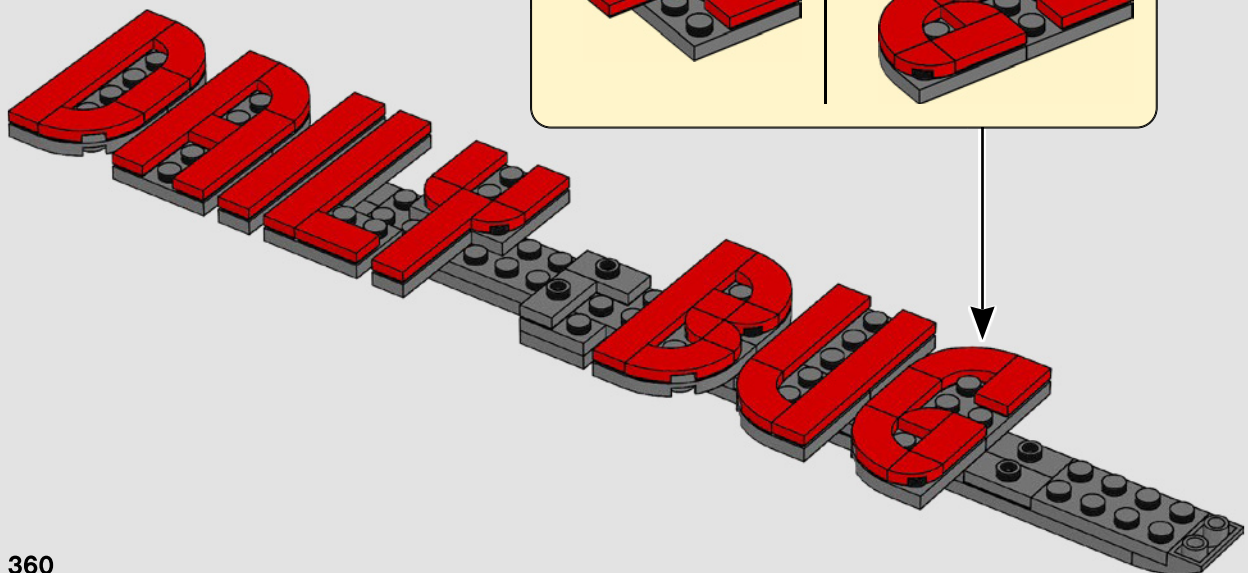

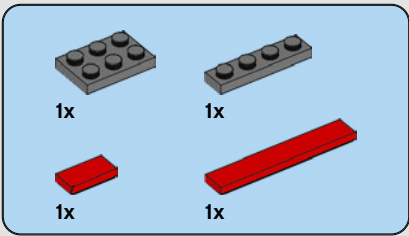

511

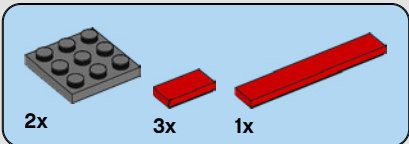
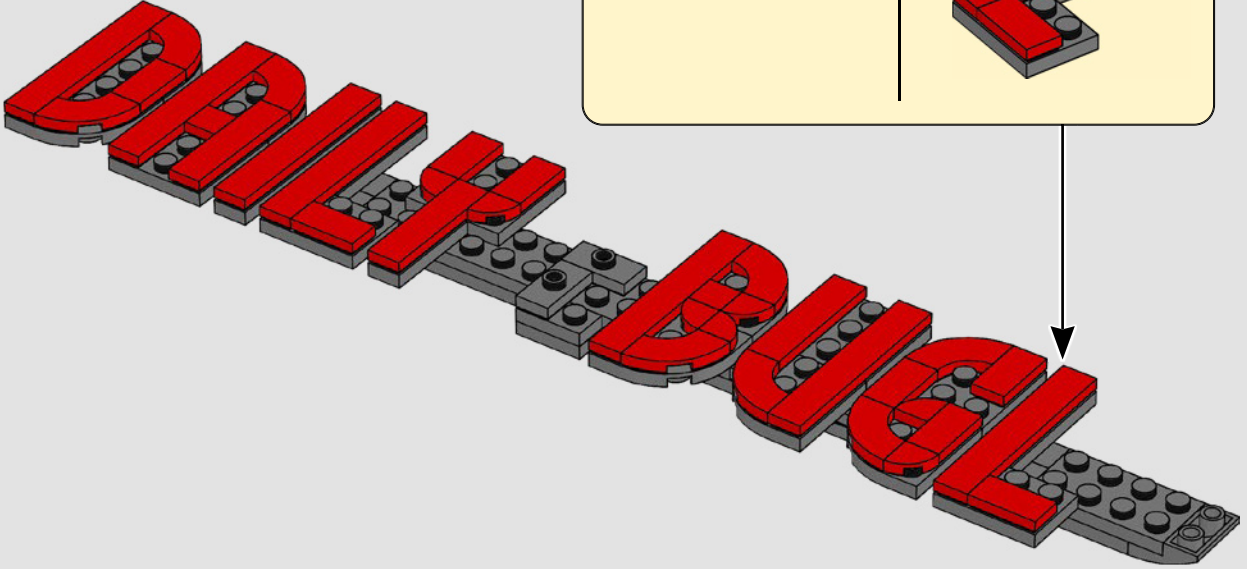
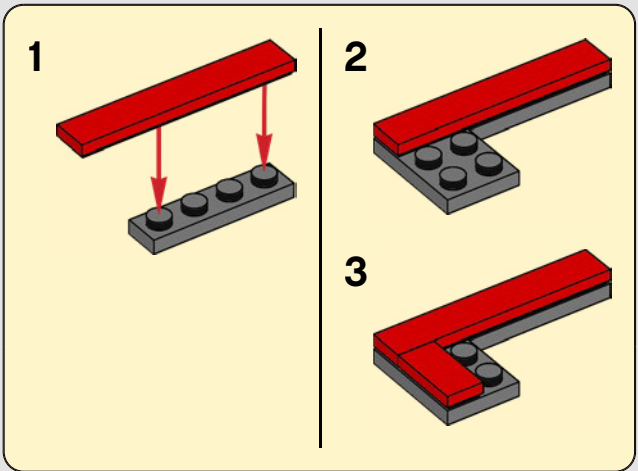

512

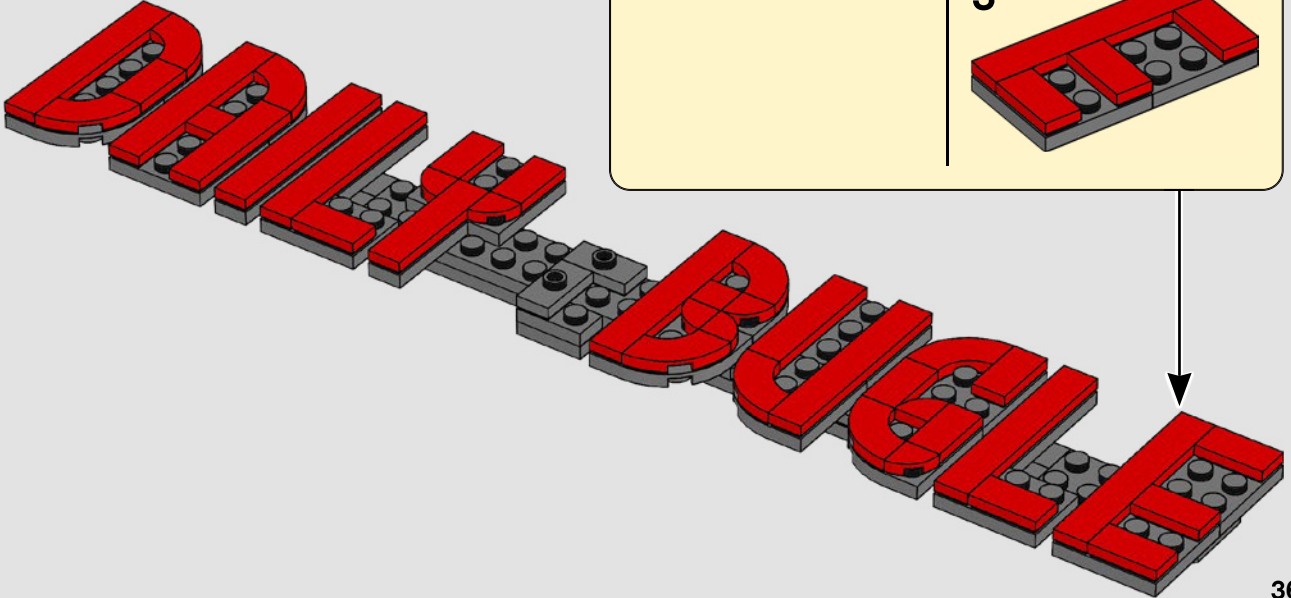
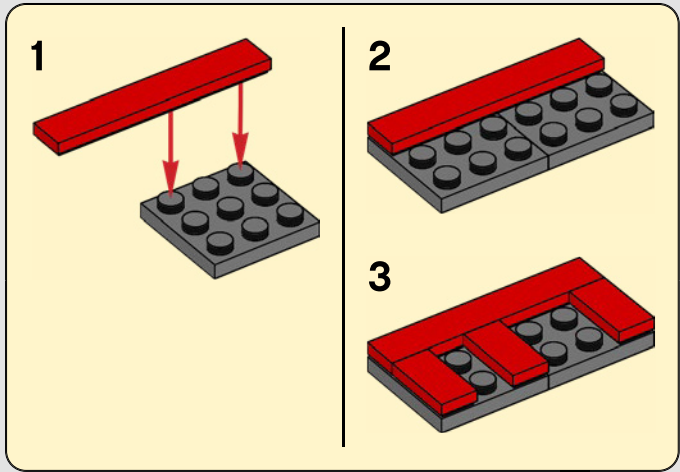





2x



2x

# 513

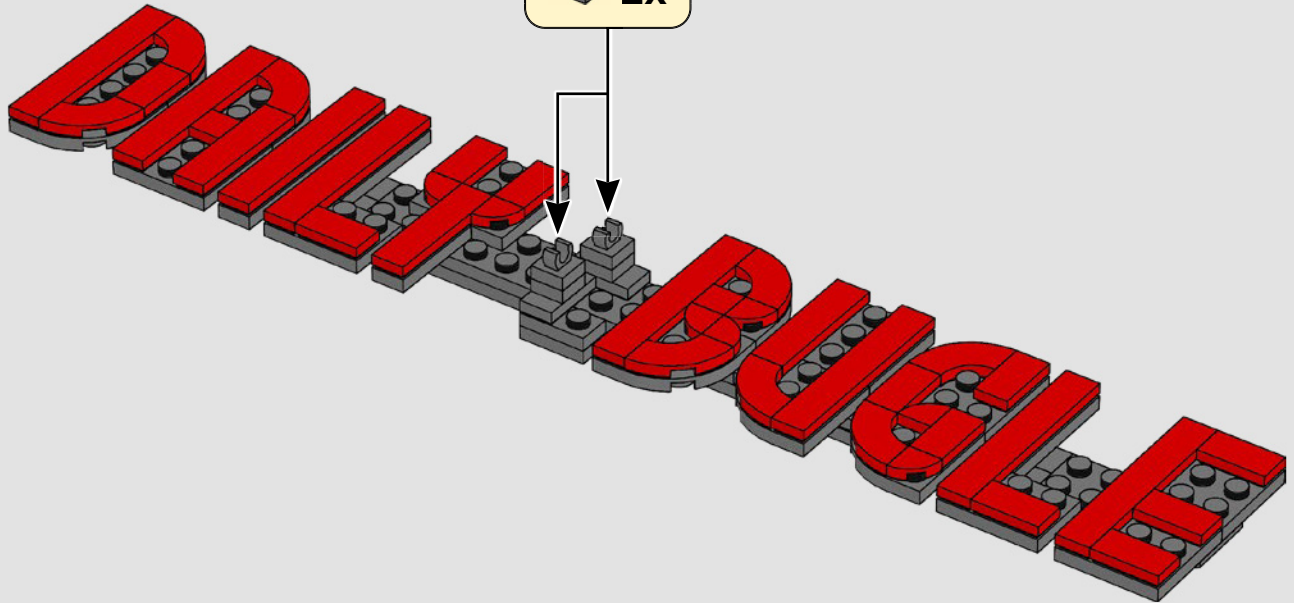
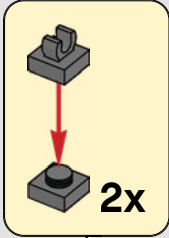

1x



2x



1x



1x



1x

# 514

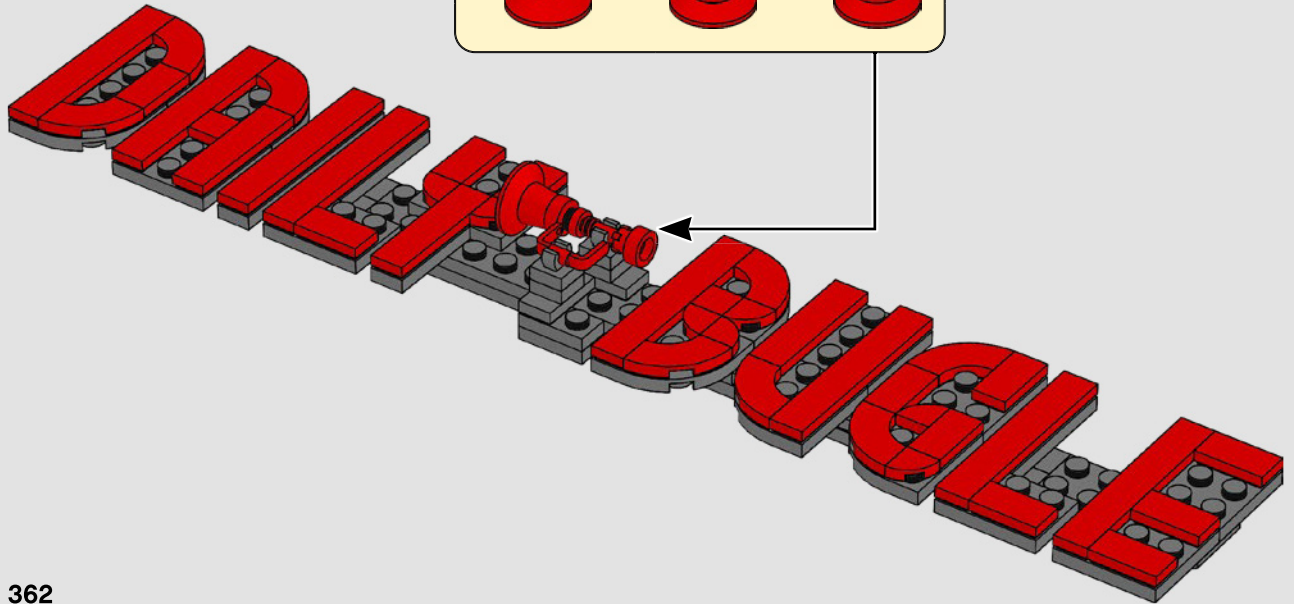
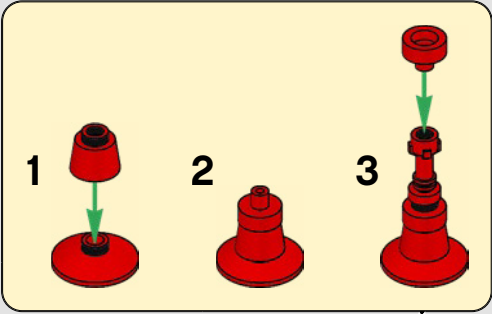

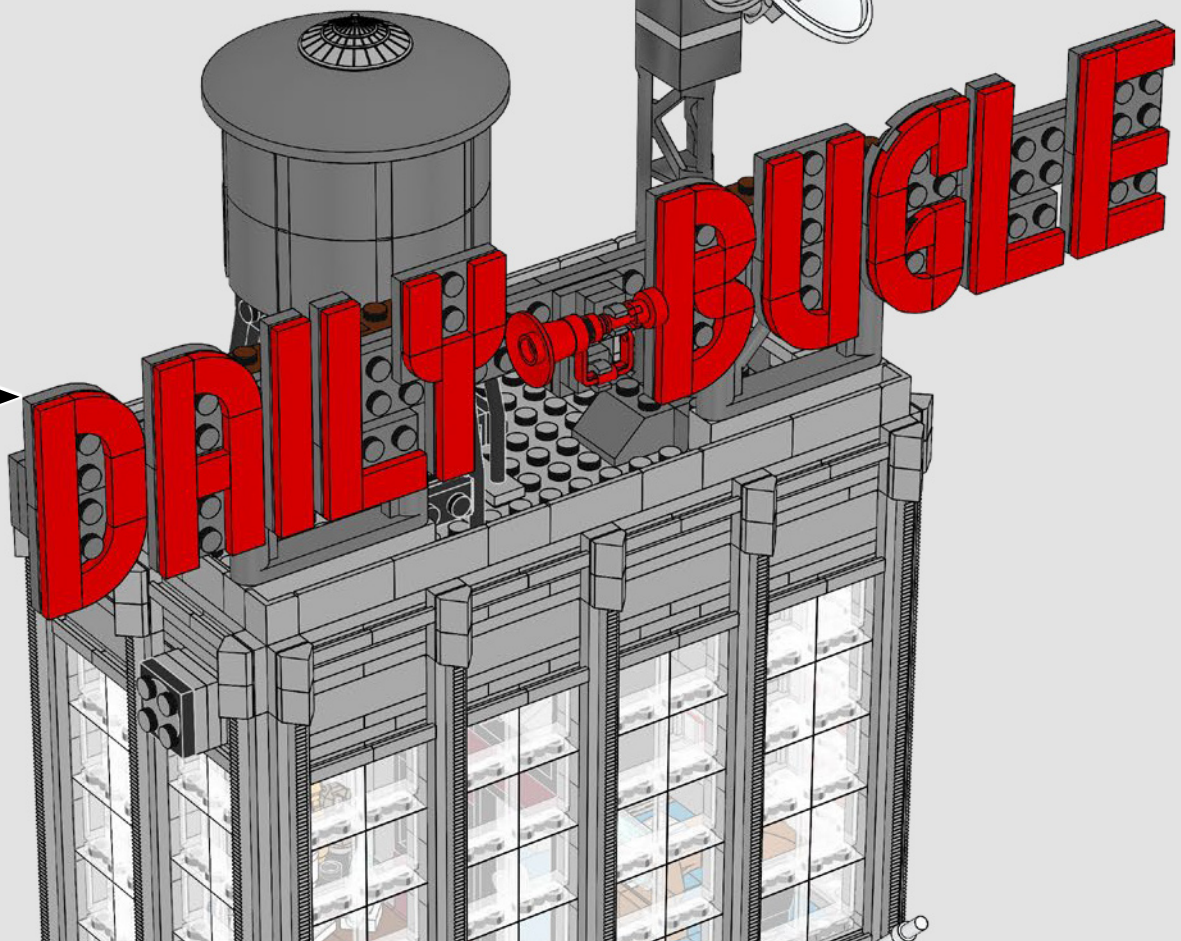
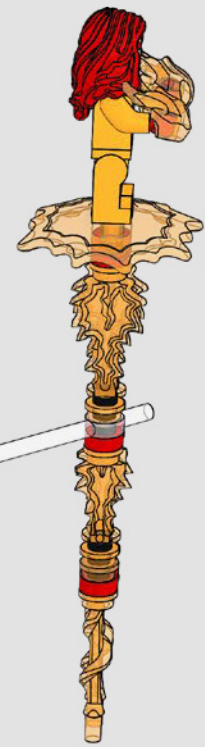
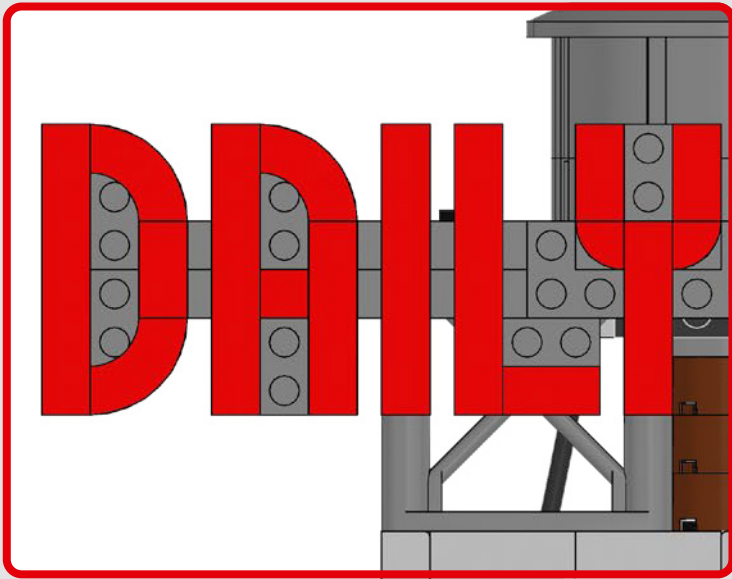

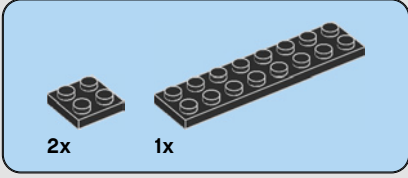
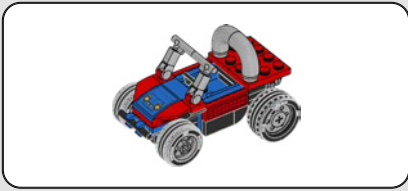

516

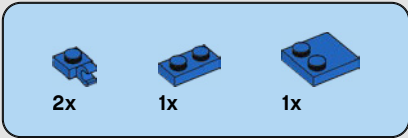
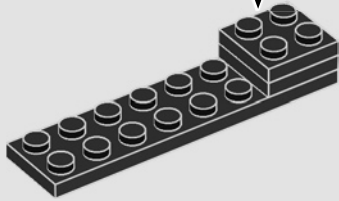
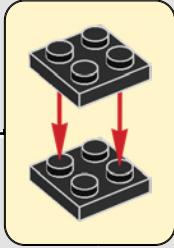

517

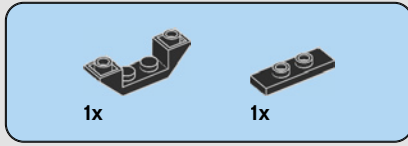
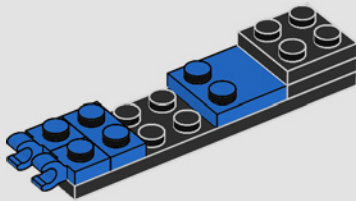

518

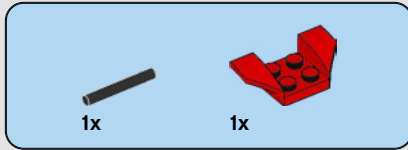
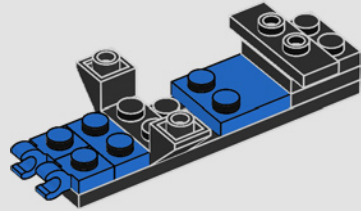

519

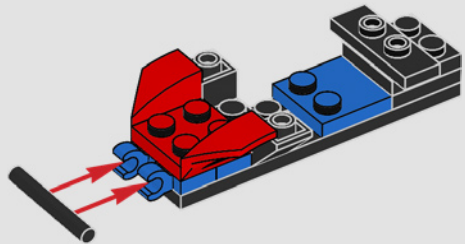



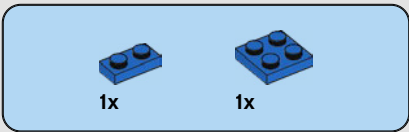

520

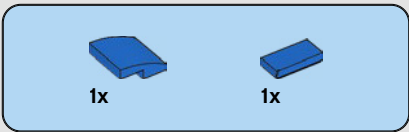
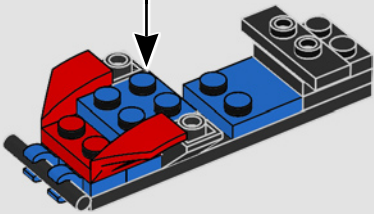
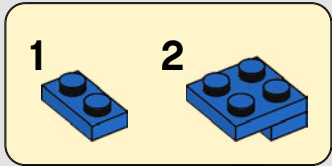

521

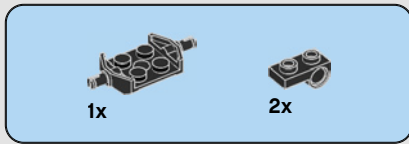
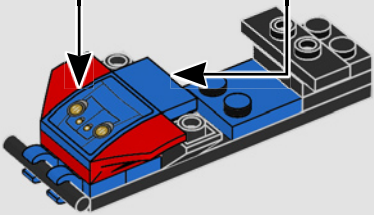
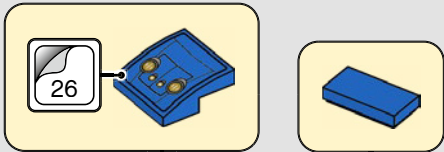

522

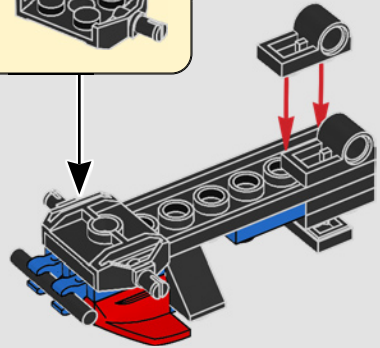
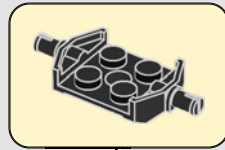
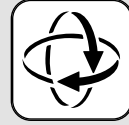

523

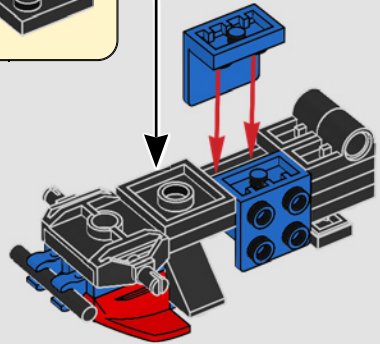
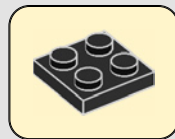

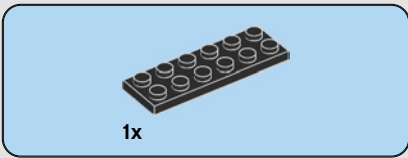

# 524

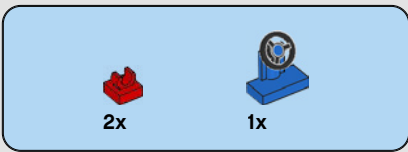
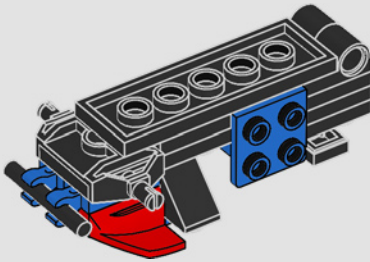

# 525

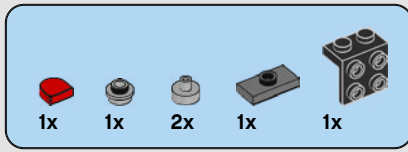
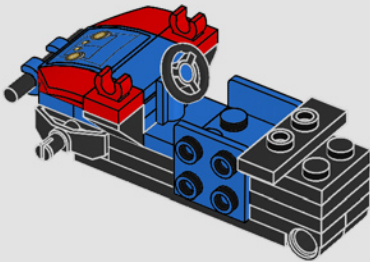

# 526

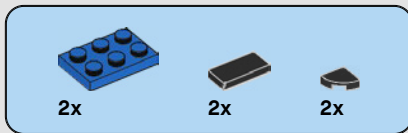
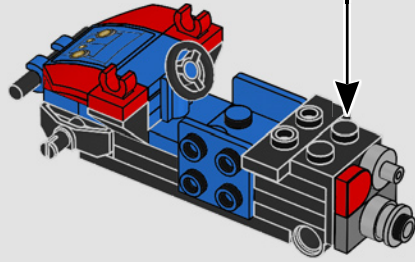
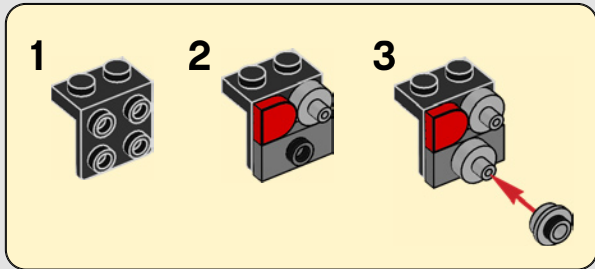

# 527

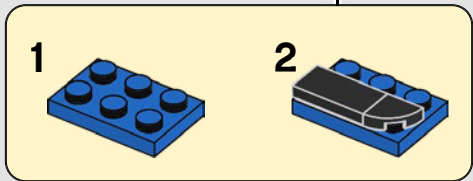
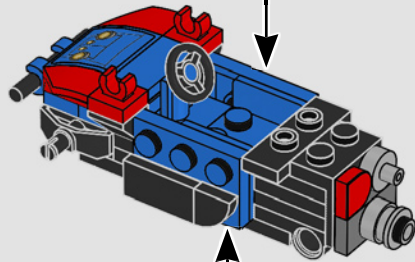
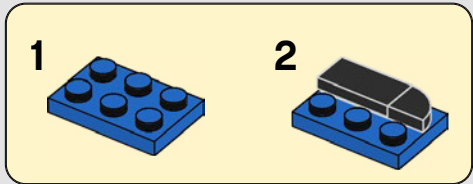

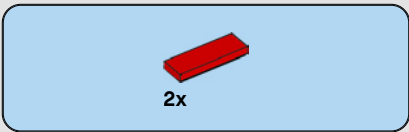

528

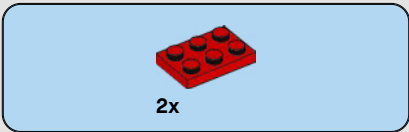
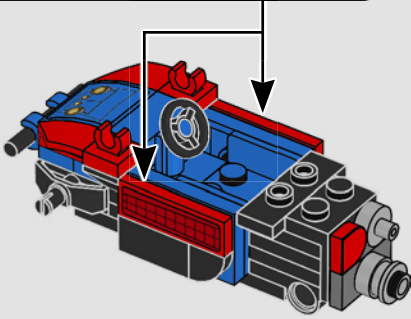
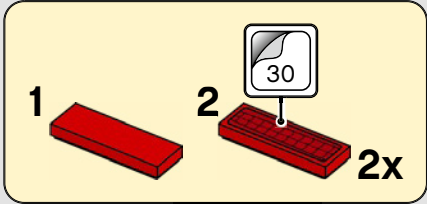

529

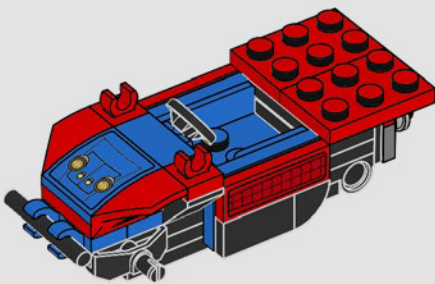

530

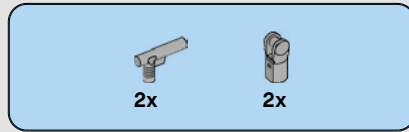
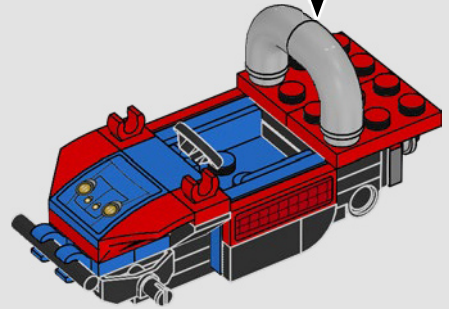
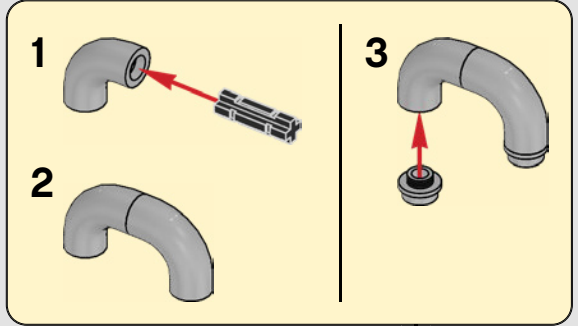

531

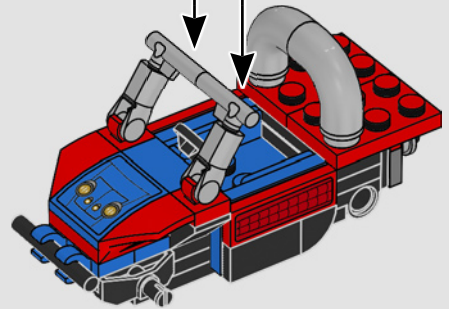
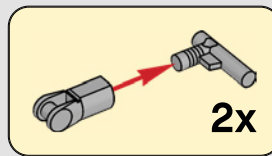



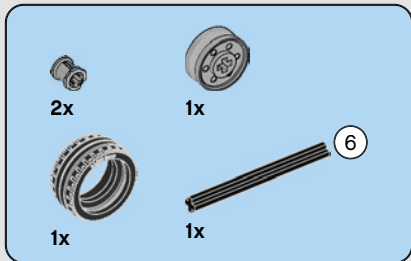

# 532

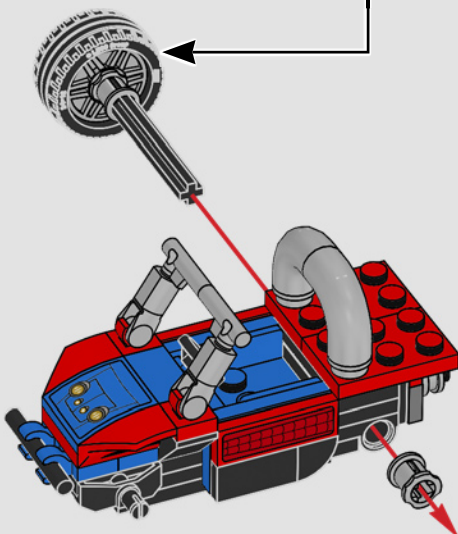
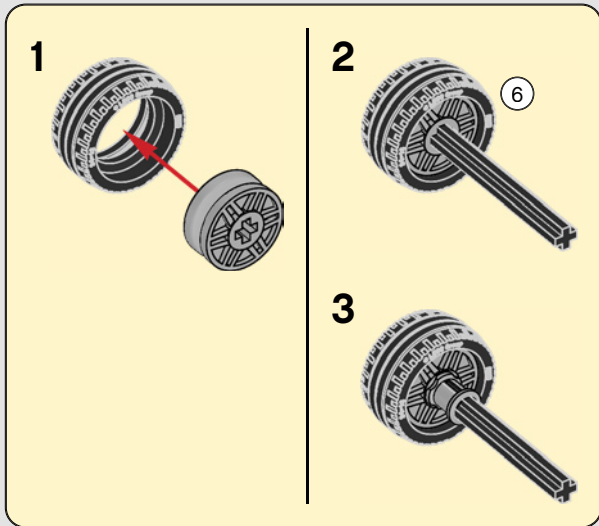

# 533

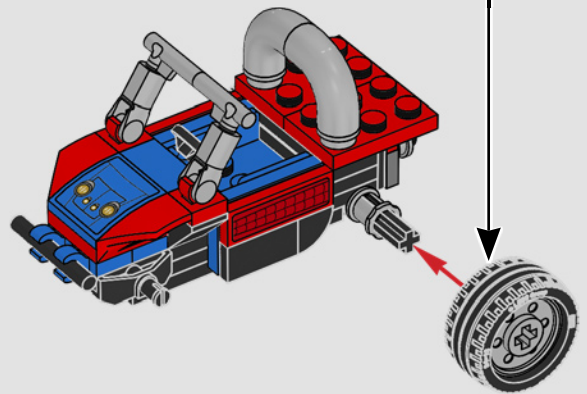
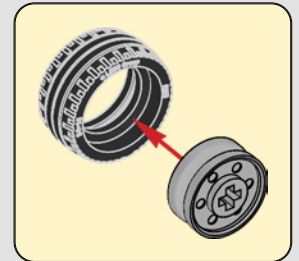

# 534

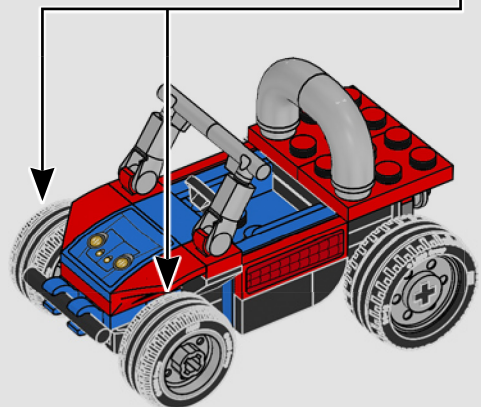
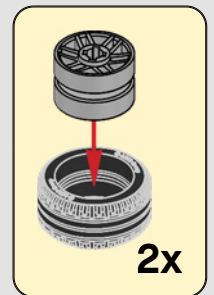

535

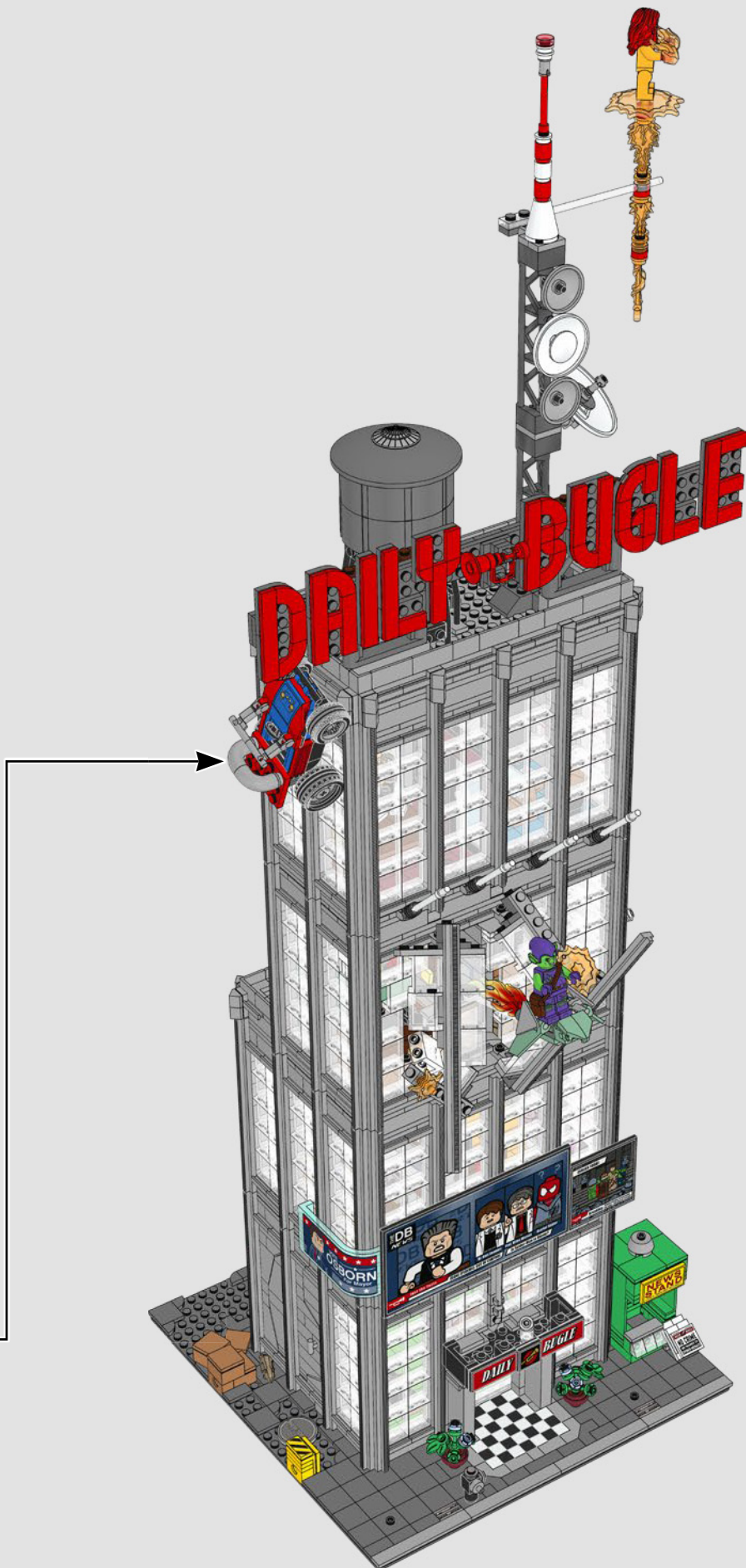





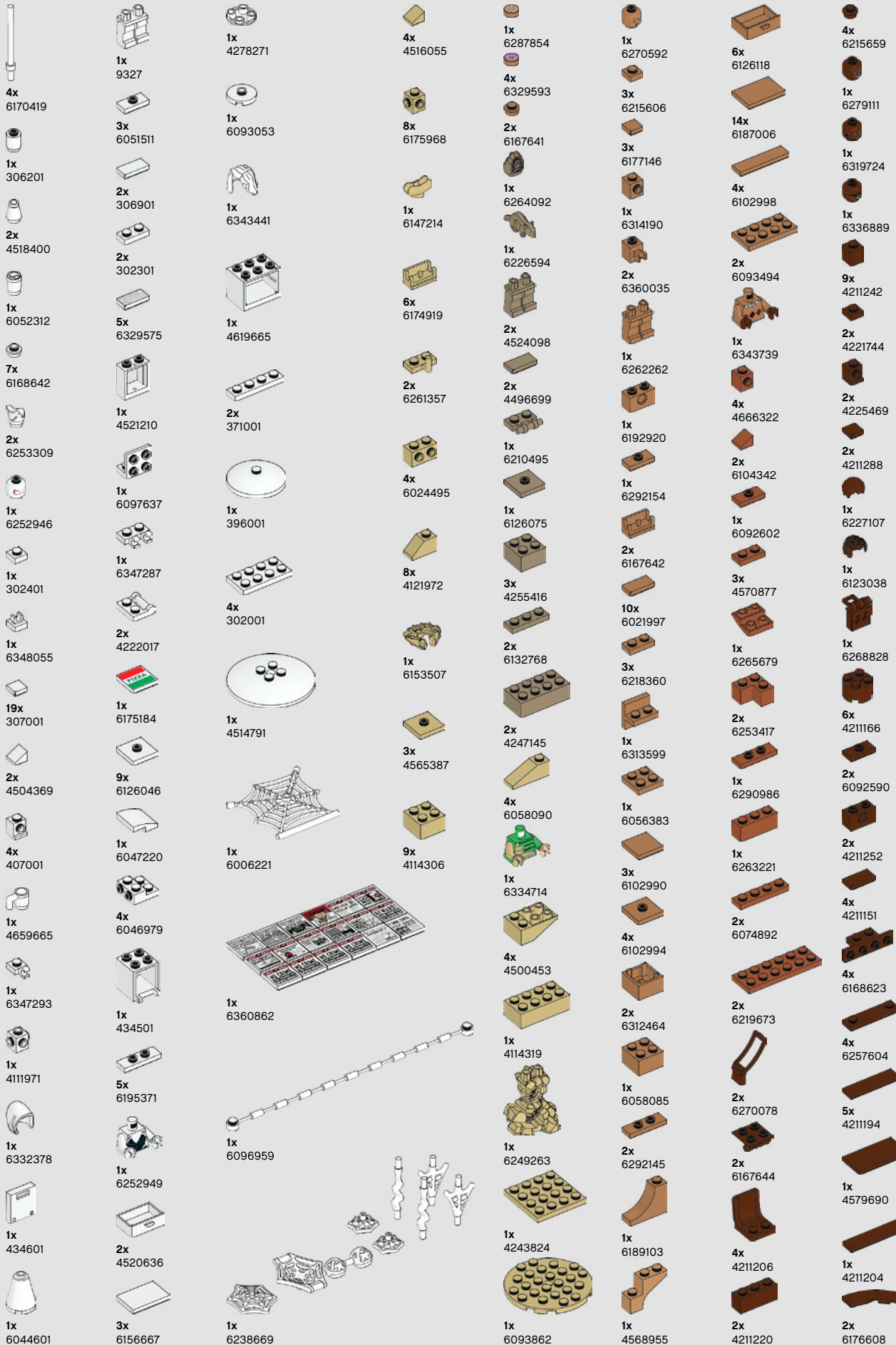

8x 6284585		7x 6170390		1x 6298839		1x 6213681			1x 6295322		1x 6329761
2x 4541376	1x 6170487	14x 6348058		1x 4140585		1x 6334072		2x 6253441	1x 6295322	1x 6172375	1x 6172375
1x 6212007	1x 6231857	3x 307021		2x 6275080		1x 6329763	1x 6329763		1x 6333405	14x 6314378	14x 6314378
1x 6329789	5x 6341972	2x 407021		2x 6269079		1x 6334083	1x 6334083	3x 6337281	1x 4226869	13x 6195258	13x 6195258
2x 6058218	3x 306221	1x 300521		1x 6270094		1x 6334083	1x 6334083	1x 6343492	1x 4212454	44x 6294513	44x 6294513
3x 4613761	2x 6223427	1x 4190219		8x 6310198		1x 6167464	1x 6167464	1x 6343492	1x 6087084	4x 6318735	4x 6318735
13x 4539105	2x 6215539	1x 389921		12x 6078641		2x 4143005	2x 4143005	1x 6345278	1x 6221730	12x 6135287	12x 6135287
3x 4539060	1x 6347805	1x 6347644		2x 235721		2x 6347291	2x 6347291	4x 4653267	6x 6221730	3x 4187334	3x 4187334
1x 4539061	1x 6258973	1x 6253815		14x 4533742		1x 6352221	1x 6352221	2x 6226919	1x 6258159	2x 6229130	2x 6229130
3x 6052777	1x 6329750	3x 6210269		1x 6223059		1x 4543857	1x 4543857	4x 6152110	1x 6221729	1x 74040	1x 74040
2x 4541528	1x 6254418	1x 4585146		1x 6305986		2x 9341	2x 9341	1x 6029163	1x 6221729	1x 6170765	1x 6170765
1x 6331698	1x 6336885	1x 6254428		1x 6343740		1x 6252799	1x 6252799	1x 6206809	1x 4206504	2x 4107736	2x 4107736
1x 4535553	1x 6344698	1x 9342		1x 6254427		2x 306923	2x 306923	14x 6205087	1x 6223168	6x 302328	6x 302328
1x 6266865	1x 6346803	6x 243221		1x 6331882		2x 302323	2x 302323	3x 6205089	4x 4616581	3x 6230235	3x 6230235
1x 6065515	1x 6345280	1x 300421		6x 6296954		1x 9566	1x 9566	1x 6136419	3x 4655080	1x 6092586	1x 6092586
1x 6278987	18x 6329920	11x 306921		2x 302121		2x 6133720	2x 6133720	1x 6047056	1x 6223234	2x 6269940	2x 6269940
3x 4565394	1x 4560179	2x 302321		2x 6189130		1x 302223	1x 302223	1x 4162916	3x 6184432	5x 6023083	5x 6023083
1x 6196221	2x 6253828	2x 6117974		3x 243121		1x 6116786	1x 6116786	2x 6273588	1x 6223126	4x 4107758	4x 4107758
2x 4520638	8x 4113858	1x 6319330		1x 6109466		1x 6252060	1x 6252060	1x 6325955	2x 6155255	6x 6288100	6x 6288100
	6x 303221	1x 6089698		1x 6343473				1x 6184348	1x 6223171	2x 4112838	2x 4112838
	8x 6329922	1x 6343473						6x 6177081	1x 6184348	2x 6251117	2x 6251117



1x  
6003033



2x  
6099717



4x  
6307254



6x  
6072668



15x  
4621543



2x  
6097511



1x  
6073040



2x  
6292415



1x  
6215422



4x  
6028736



6x  
4622062



9x  
6020147



7x  
6193972



1x  
6343491



2x  
6248971



2x  
6261367



2x  
6119197



1x  
6329649



2x  
302324



4x  
366524



1x  
6348056



8x  
6297284



1x  
370024



3x  
306924



6x  
6344181



1x  
6117938



3x  
6057458



2x  
302224



4x  
6079007



1x  
6223076



8x  
242024



6x  
4558172



3x  
302124



3x  
301024



1x  
4560181



1x  
302024



2x  
4599378



4x  
366624



1x  
6130009

7



2x  
4504381



3x  
302424



1x  
74156



4x  
300224



4x  
6344180



1x  
6257598



2x  
371024



2x  
6275877



1x  
6092833



1x  
6192037



1x  
6124907



1x  
6154064



1x  
6267761



1x  
6336891



1x  
6315038



1x  
6336887



1x  
6329755



1x  
6336893



1x  
6336894



1x  
6021888



1x  
6162427



1x  
4618670



1x  
6096589



1x  
6322281



1x  
6100562



1x  
6253164



3x  
6335932



2x  
4529247



4x  
6186672



1x  
6051507



1x  
6217498



7x  
6322904



28x  
4633691



24x  
4619636



1x  
6020990



2x  
6116593



1x  
6184874



2x  
6263553



1x  
6244794



1x  
6247364



1x  
6247364



1x  
6247364



4x  
6252046



4x  
6209683



1x  
6324167



2x  
6359231



2x  
6285587



2x  
6223655



4x  
6244904



1x  
6283590



1x  
6273153



1x  
6245307



1x  
6245307



1x  
6245307



1x  
6245307



1x  
6245307



1x  
6245307



1x  
6245307



1x  
6245307



1x  
6245307



1x  
6245307



1x  
6247798



2x  
6240030



1x  
6168665



4x  
6245250



2x  
6244796



1x  
6220959



7x  
6252041



2x  
6254254



2x  
6252258



3x  
6163901



2x  
6244904



347x  
6253231



1x  
6240204



1x  
6247362



1x  
6247362



3x  
6253734



1x  
6245253



1x  
6245253



1x  
6245253



1x  
6245253



1x  
6254564



1x  
6239388





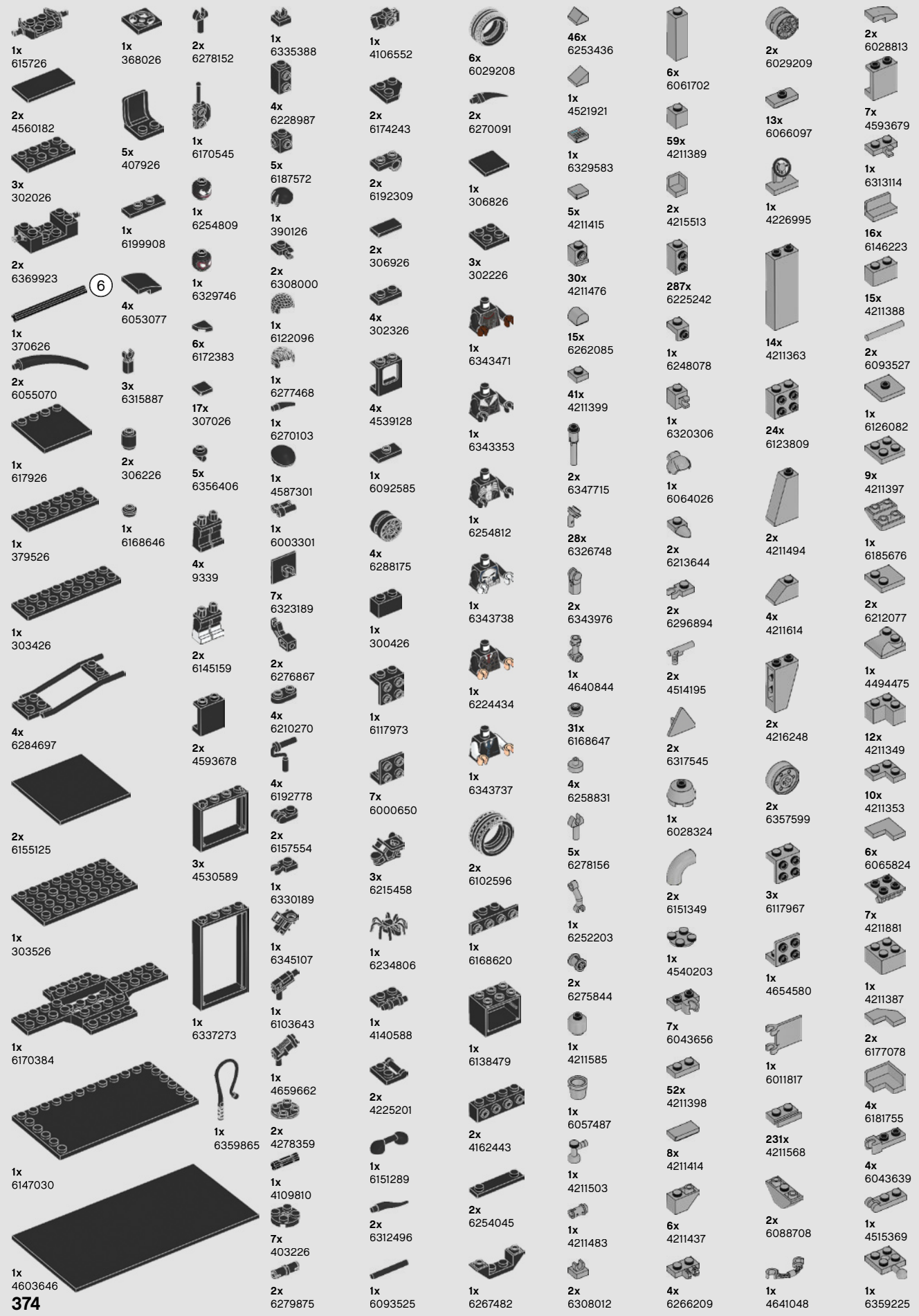



1x  
6310418



1x  
6310369



15x  
4211392

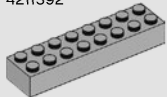

6x  
6037399



1x  
4222019



28x  
4251149

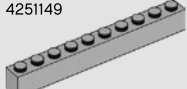

7x  
4211521



9x  
4211462



3x  
4514846



11x  
4211405



3x  
4662161



67x  
6333276



3x  
4211366



7x  
4211486



3x  
4293831



20x  
4211428



42x  
4211429



2x  
4211489



2x  
6211969



2x  
4211488



13x  
4558169



2x  
6248917



1x  
4211396



2x  
4610112



2x  
4211386



12x  
6071299



10x  
4211356



62x  
4211394



94x  
4211445



1x  
6195463



2x  
4211636



16x  
6257593



6x  
4211395



1x  
4211491



1x  
6187170



1x  
6306721



2x  
6070564



13x  
6210581



13x  
4211385



1x  
6079461



22x  
4211393



24x  
4211438



10x  
4211549



25x  
4211425



21x  
4211481



12x  
6177079



4x  
4211000



7x  
6247784



3x  
4211054



10x  
4211362



24x  
6267495



1x  
6170569



1x  
6170418



1x  
4539481



4x  
6336970



2x  
6271752



2x  
4210719



2x  
4210848



3x  
6344022



51x  
4558955



26x  
6199549



2x  
6170811



1x  
6276870



1x  
6345687



2x  
6281996



2x  
6143417



2x  
6143423



4x  
6265702



2x  
6296892



1x  
6055313



1x  
4211042



1x  
4211010



1x  
6120935



31x  
4211052



19x  
6092572



10x  
6039479



2x  
4211063



1x  
6329592



1x  
4211133



3x  
4568734



1x  
4211056



11x  
6321746



1x  
4211067



5x  
4210796



2x  
4542618



1x  
6187008



7x  
4211043



2x  
4211001



2x  
4528323



8x  
6039176



8x  
4212075



4x  
4211065

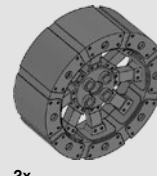
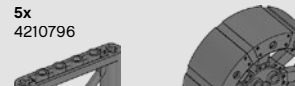

2x  
6264148

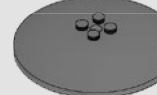

1x  
4268409

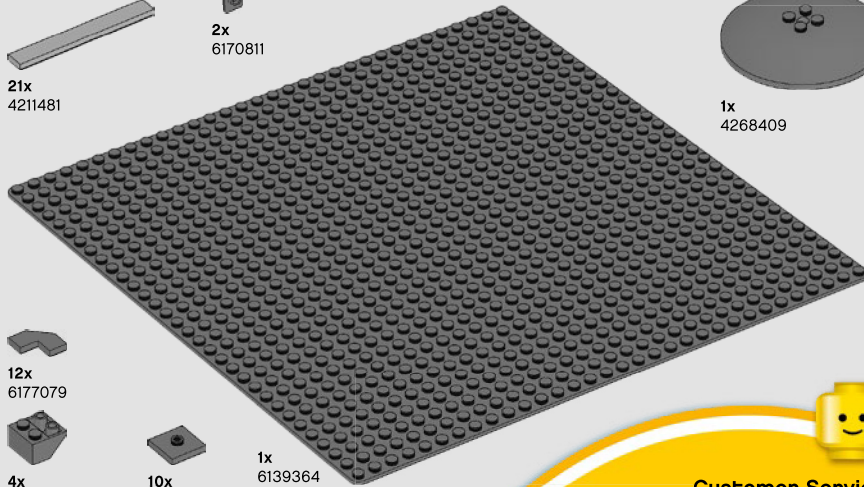

Customer Service

Kundenservice

Service Consommateurs

Servicio Al Consumidor

LEGO.com/service or dial



: 00800 5346 5555

: 1-800-422-5346



# FEEDBACK AND WIN

## FEEDBACK AND WIN

Your feedback will help shape the future development of this product series.

Please visit:

## FEEDBACK UND GEWINNEN

Dein Feedback trägt zur Weiterentwicklung dieser Produktreihe bei.

Geh auf:

## COMMENTEZ ET GAGNEZ

Vos commentaires nous aideront à concevoir les futurs produits de cette gamme.

Rendez-vous sur :

## COMENTA Y GANA

Tu opinión nos ayudará a dar forma al desarrollo de esta serie de productos en el futuro.

Visita:

## 反馈有奖

您的反馈将有助于我们在今后改进本系列产品。

请访问：

[LEGO.com/productfeedback](https://www.lego.com/productfeedback)

By completing, you will automatically enter a drawing to win a LEGO® set.

Terms & Conditions apply.

Durch Ausfüllen nimmst du automatisch an der Verlosung eines LEGO® Preises teil.

Es gelten die Teilnahmebedingungen.

En envoyant vos commentaires, vous serez automatiquement inscrit(e) à un tirage au sort qui vous permettra de remporter un prix LEGO®.

Offre soumise à conditions.

Al contestar, participarás automáticamente en el sorteo y podrás ganar un set LEGO®.

Sujeto a Términos y Condiciones.

完成我们的反馈调查，即可自动进入抽奖环节，赢取乐高®套装。

适用《条款和条件》。